

CKM Mumbai - 30 November 2016



# Mixing induced CP violation in $B_d$ decays

---

**Marta Calvi**

**University of Milano Bicocca and INFN**

**On behalf of the LHCb Collaboration**



- Large CPV is expected in interference between  $B^0$  decays with or w/o mixing.

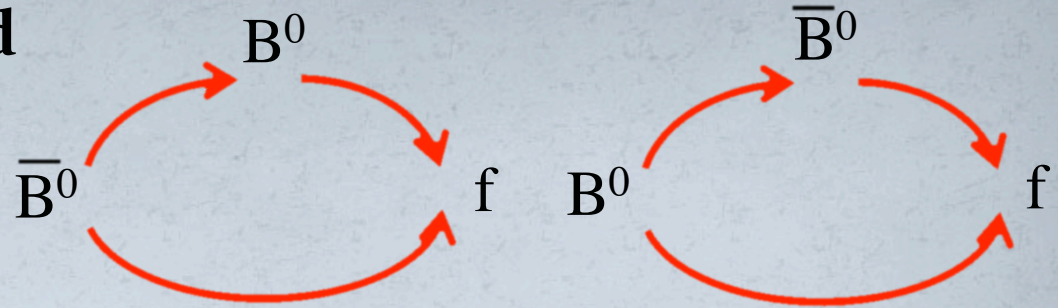

- Measurements of CP phase provide constraints to SM parameters and probe for BSM physics

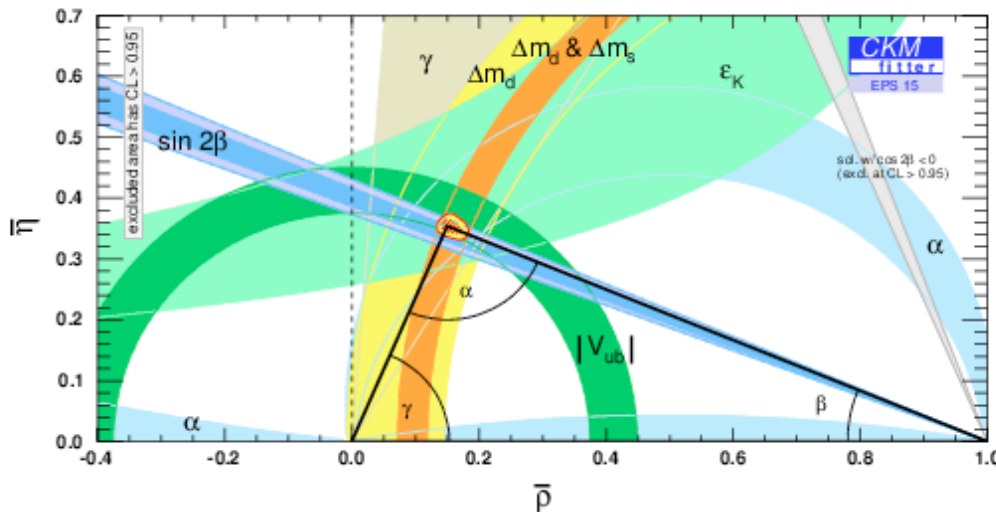

$$\beta \equiv \arg\left[-(V_{cd}V_{cb}^*)/(V_{td}V_{tb}^*)\right]$$

- $\beta = (21.9 \pm 0.7)^\circ$  wa
  - $\beta^{\text{SM}} = (24.3^{+1.3}_{-1.4})^\circ$
- CKMFitter, all meas. except  $\beta$

# $B^0 \rightarrow J/\psi K_S$

- Dominated by tree  $b \rightarrow c \bar{c} s$  transition in SM  $S = \sin(2\beta)$

$$\mathcal{A}(t) \equiv \frac{\Gamma(\bar{B}^0(t) \rightarrow J/\psi K_S^0) - \Gamma(B^0(t) \rightarrow J/\psi K_S^0)}{\Gamma(\bar{B}^0(t) \rightarrow J/\psi K_S^0) + \Gamma(B^0(t) \rightarrow J/\psi K_S^0)}$$

$$= S \sin(\Delta m t) - C \cos(\Delta m t)$$

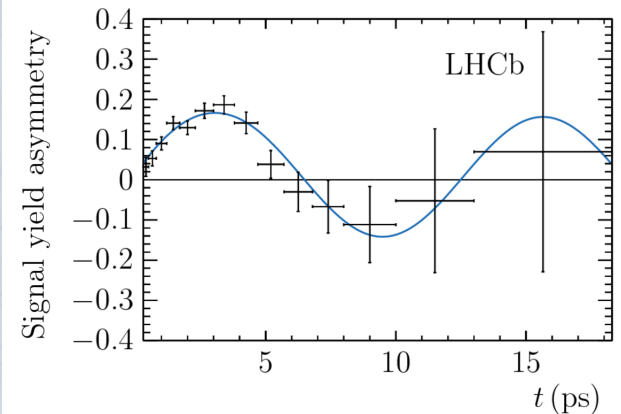
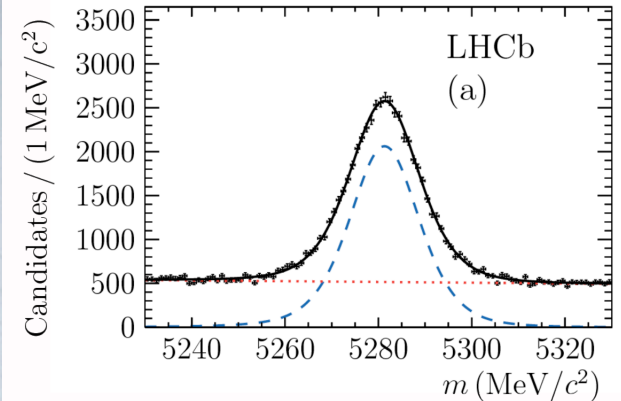
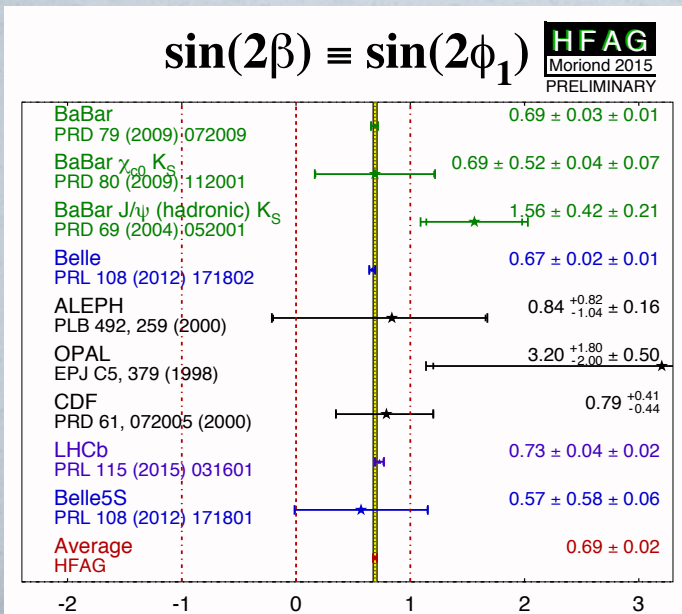

- LHCb with RUN I data ( $3 \text{ fb}^{-1}$ )  
41 560  $\pm$  270 candidates

$$S = 0.731 \pm 0.035(\text{stat}) \pm 0.020(\text{syst}),$$

$$C = -0.038 \pm 0.032(\text{stat}) \pm 0.005(\text{syst})$$

$$\rho(S, C) = 0.483$$

PRL 115 (2015) 031601

# $B^0 \rightarrow J/\psi K_S$ prospects

- $2\text{fb}^{-1}$  (2015+2016) at 13 TeV already on tape  
→ more than double data yield

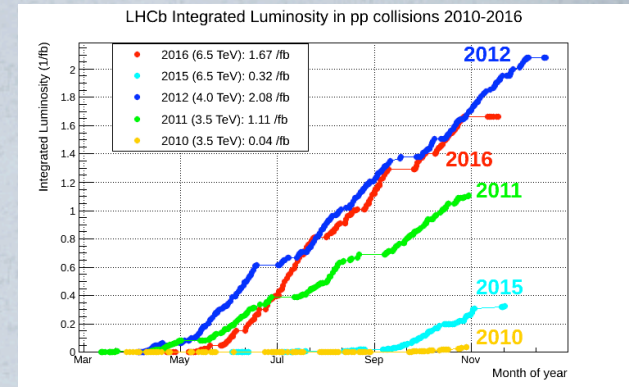

Origin systematics	$\sigma_S$	$\sigma_C$
Background tagging asymmetry	0.0179 (2.5%)	0.0015 ( 4.5%)
Tagging calibration	0.0062 (0.9%)	0.0024 ( 7.2%)
$\Delta\Gamma$	0.0047 (0.6%)	—
Fraction of wrong PV component	0.0021 (0.3%)	0.0011 ( 3.3%)
$z$ -scale	0.0012 (0.2%)	0.0023 ( 7.0%)
$\Delta m$	—	0.0034 (10.3%)
Upper decay time acceptance	—	0.0012 ( 3.6%)
Correlation between mass and decay time	—	—
Decay time resolution calibration	—	—
Decay time resolution offset	—	—
Low decay time acceptance	—	—
Production asymmetry	—	—
Sum	0.020 (2.7%)	0.005 (15.2%)

- **Small systematic uncertainties, will decrease with increasing data samples.**
  - **Currently dominated by background tagging asymmetry.**

PRL 115 (2015) 031601

- **Higher tagging power available from new algorithms**
- **Control of penguin contributions from measurements in other channels**

# $B_s^0 \rightarrow J/\psi K_S$

- Under approximated SU(3) symmetry allow to control size of penguin amplitudes in  $B^0 \rightarrow J/\psi K_S$
- LHCb with  $3 \text{ fb}^{-1}$   
 $908 \pm 36$  signal candidates

$$\mathcal{B}(B_s^0 \rightarrow J/\psi K_S^0) / \mathcal{B}(B^0 \rightarrow J/\psi K_S^0)$$

$$0.0431 \pm 0.0017 \text{ (stat)} \pm 0.0012 \text{ (syst)} \pm 0.0025 (f_s/f_d)$$

- Tagged time-dependent analysis

$$C_{\text{dir}} = -0.28 \pm 0.41 \text{ (stat)} \pm 0.08 \text{ (syst)}$$

$$S_{\text{mix}} = -0.08 \pm 0.40 \text{ (stat)} \pm 0.08 \text{ (syst)}$$

- Precision not yet sufficient to derive constraints on  $\Delta\phi_d$
- Good prospects for RUN II

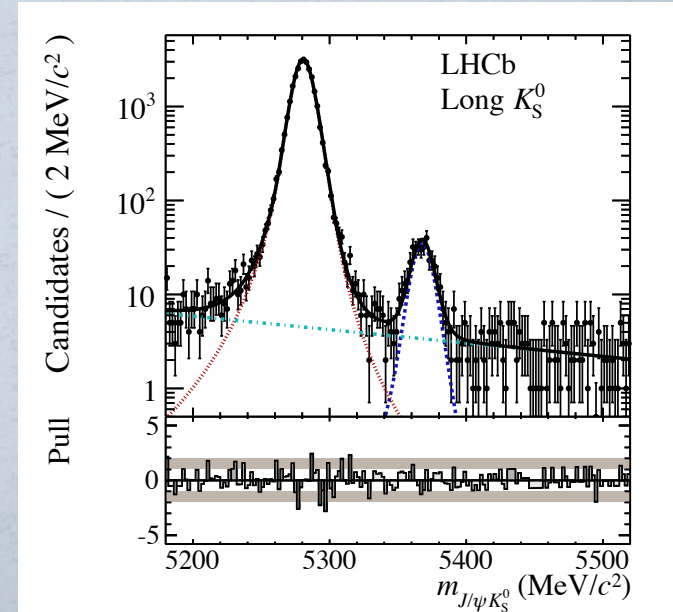
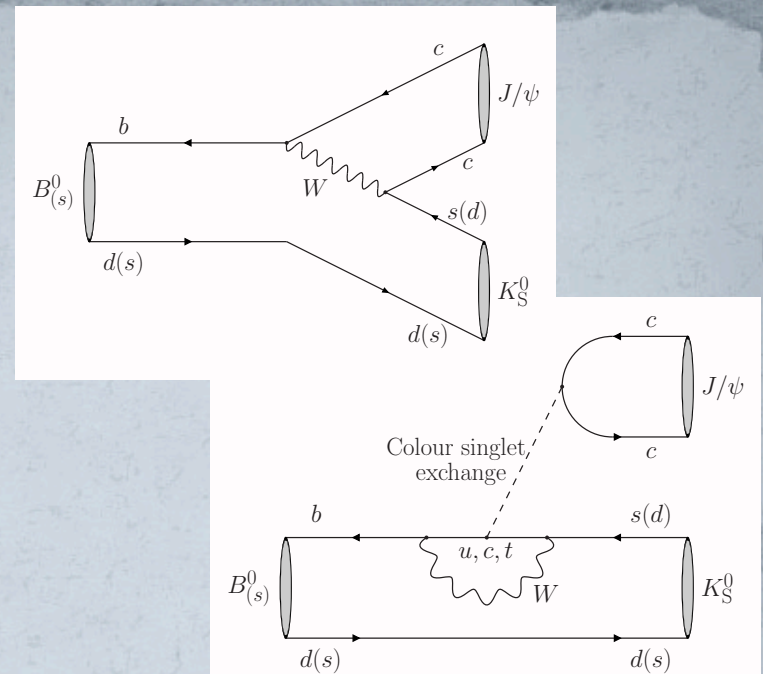

# Flavour tagging at LHCb

- Determines  $B^0$  signal flavour at production, using information from the rest of the event
- Sensitivity  $\sigma^{\text{stat}} \sim 1 / \sqrt{\varepsilon(1-2\omega)^2 N}$ 
  - $\varepsilon$  tagging efficiency
  - $\omega$  wrong tag rate
- Many algorithms combined
- Recently added/retuned: OS charm, SS pion, SS proton taggers

Same Side

Opposite Side

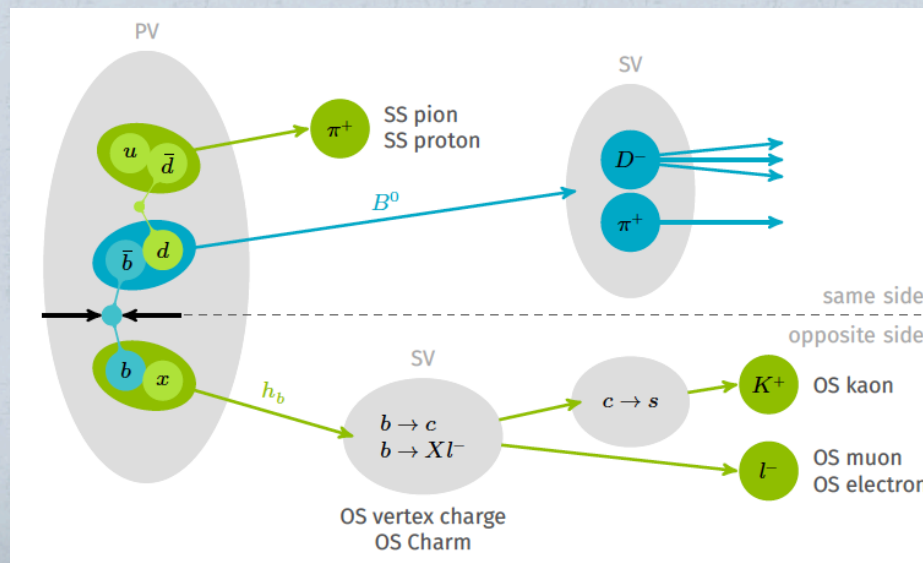

# Same Side $B^0$ flavour tagging

- Exploit correlation of signal B flavour with charge of pions (protons) from the hadronization process

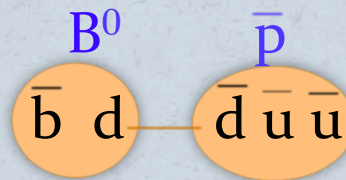
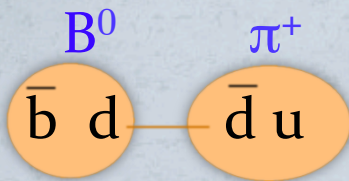

or decays of excited states, eg.  $B^{**+} \rightarrow B^0 \pi^+$

- Tagging algorithms tuned and calibrated on data using flavour specific  $B^0$  decay modes

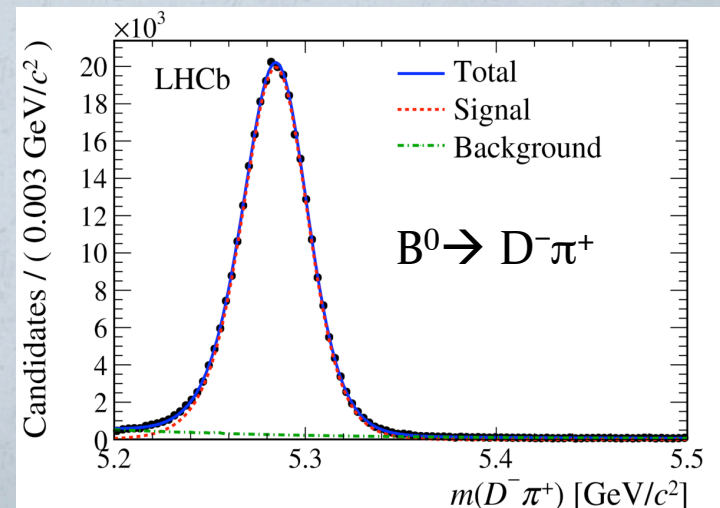

- Select pions (protons) from primary vertex and train a BDT to separate right tag/wrong tag candidates

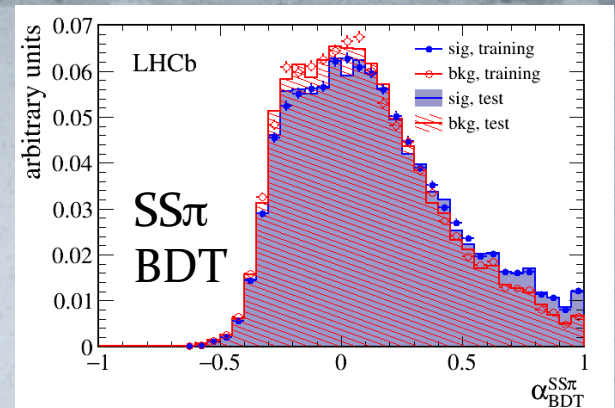

- Convert the BDT output into a mistag probability associated to that particle with a time-dependent analysis of flavour oscillations

$$A(t) = \frac{N^{\text{unmix}}(t) - N^{\text{mix}}(t)}{N^{\text{unmix}}(t) + N^{\text{mix}}(t)} = (1-2\omega) \cos(\Delta m t)$$

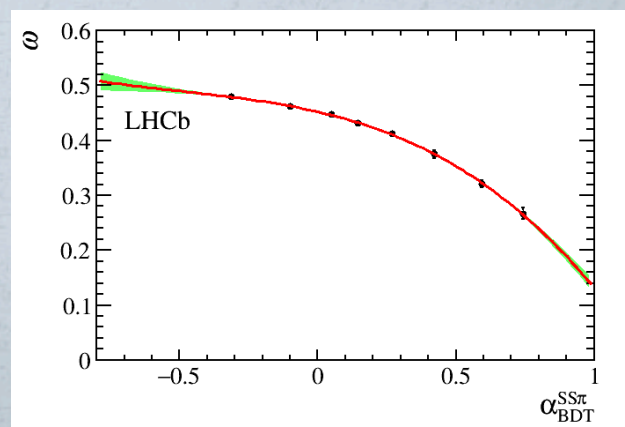
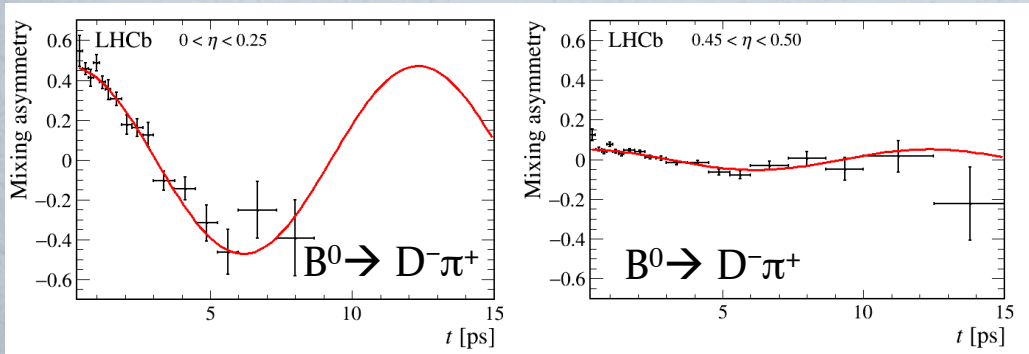

arXiv:1610.06019



- Mistag calibration checked on control samples
  - Assume linear relation between true and predicted mistag

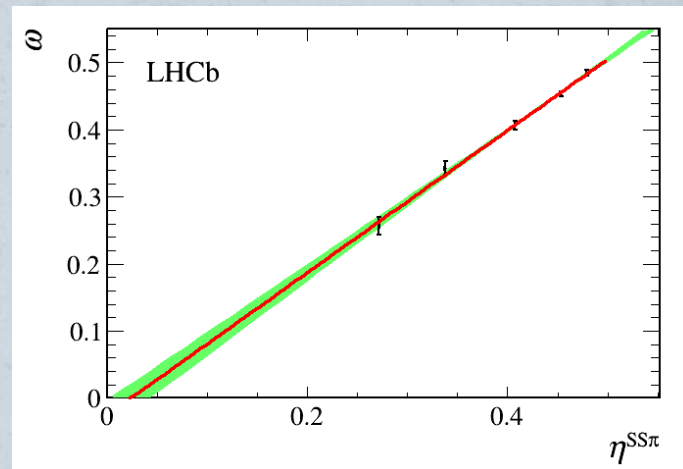
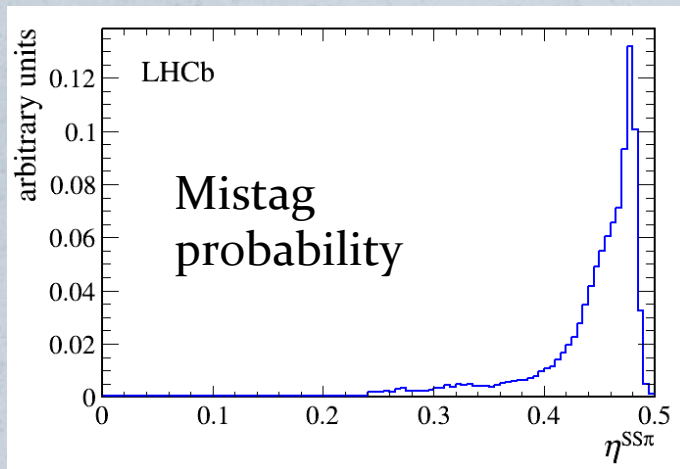

arXiv:1610.06019

- SS pion tagger gives +60% in tagging power wrt SS algorithm used for RUNI  $B^0 \rightarrow J/\psi K_S$  analysis.
- SS proton provides an additional +25%
- Final performance depends on the kinematic properties of the selected  $B^0$  decays.

# $B^0 \rightarrow D^+ D^-$

- Measure  $\sin(2\beta)$  from dominant, tree level,  $b \rightarrow c \bar{c} d$  transition
- Sensitivity to higher order contributions provide constraints to possible additional CP phases.
- Time-dependent decay rate

$$\frac{d\Gamma(t, d)}{dt} \propto e^{-t/\tau} \left( 1 - d S \sin(\Delta m t) + d C \cos(\Delta m t) \right)$$

$$S/\sqrt{1 - C^2} = -\sin(\phi_d + \Delta\phi)$$

- SM, at tree level:

$$\phi_d = 2\beta \quad C = 0$$

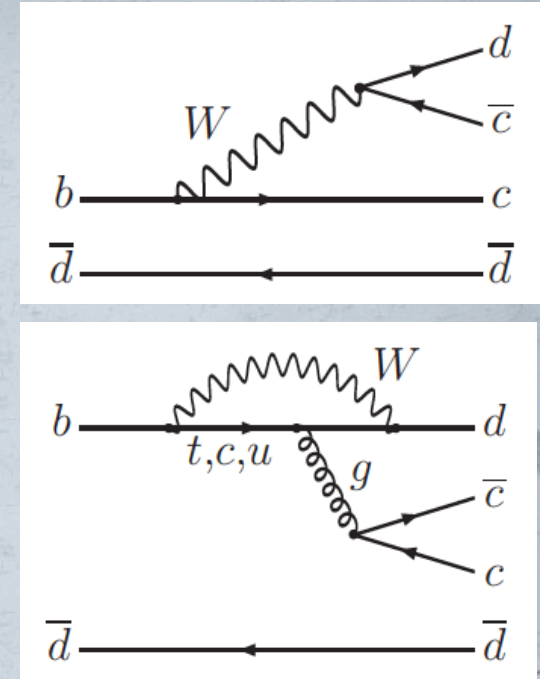

$d = \pm 1$   
 $B^0$  flavour at production

# $B^0 \rightarrow D^+ D^-$ previous results

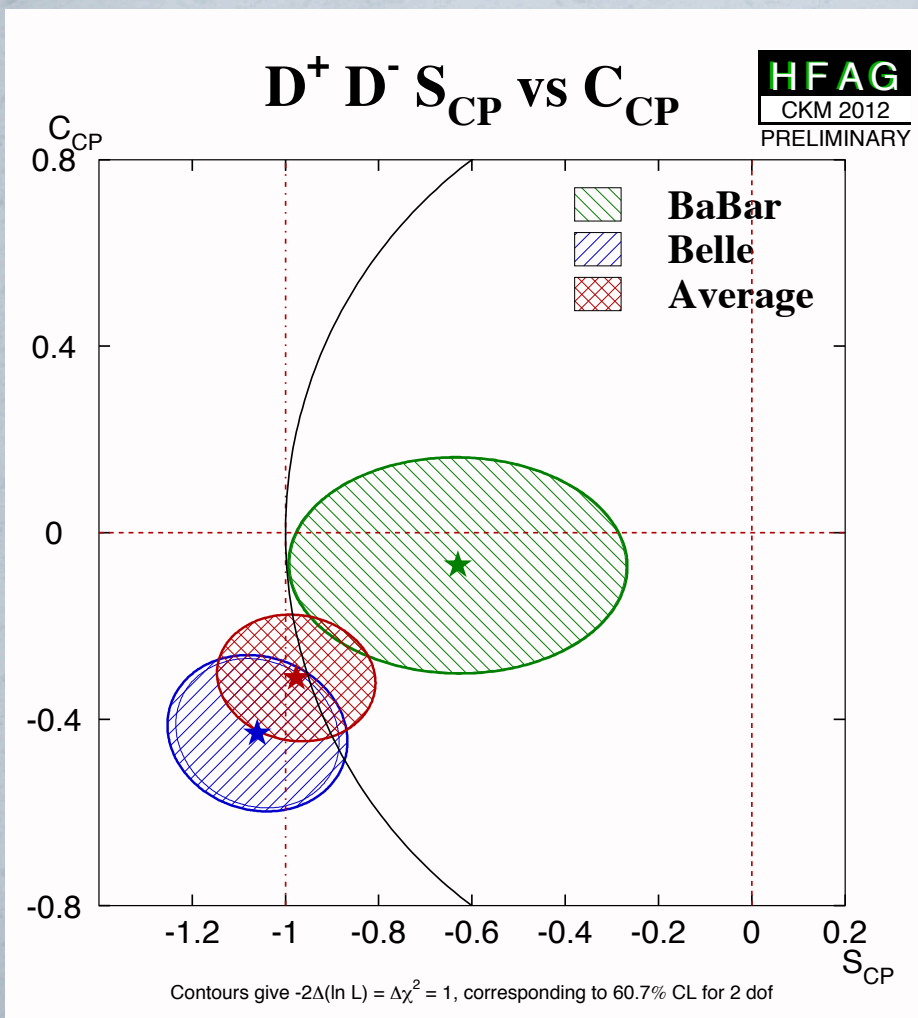

**BaBar** PRD 79 (2009) 032002

$N(BB) = 467 M$

$S = -0.63 \pm 0.36 \pm 0.05$

$C = -0.07 \pm 0.23 \pm 0.03$

**Belle** PRD 85 (2012) 091106

$N(BB) = 772M$

$S = -1.06^{+0.21}_{-0.14} \pm 0.08$

$C = -0.43 \pm 0.16 \pm 0.05$

- **Not yet a constraint to additional SM phases.**

- $B^0 \rightarrow D^+ D^- \rightarrow (K^- \pi^+ \pi^+) (K^+ \pi^- \pi^-)$   
 $\rightarrow (K^- K^+ \pi^+) (K^+ \pi^- \pi^-), (K^- \pi^+ \pi^+) (K^+ K^- \pi^-)$

- Two BDTs used to suppress combinatorial background.
- Requirements on decay time significance of each D to suppress contamination of  $B \rightarrow D K \pi \pi$  and  $B \rightarrow D K K \pi$  decays

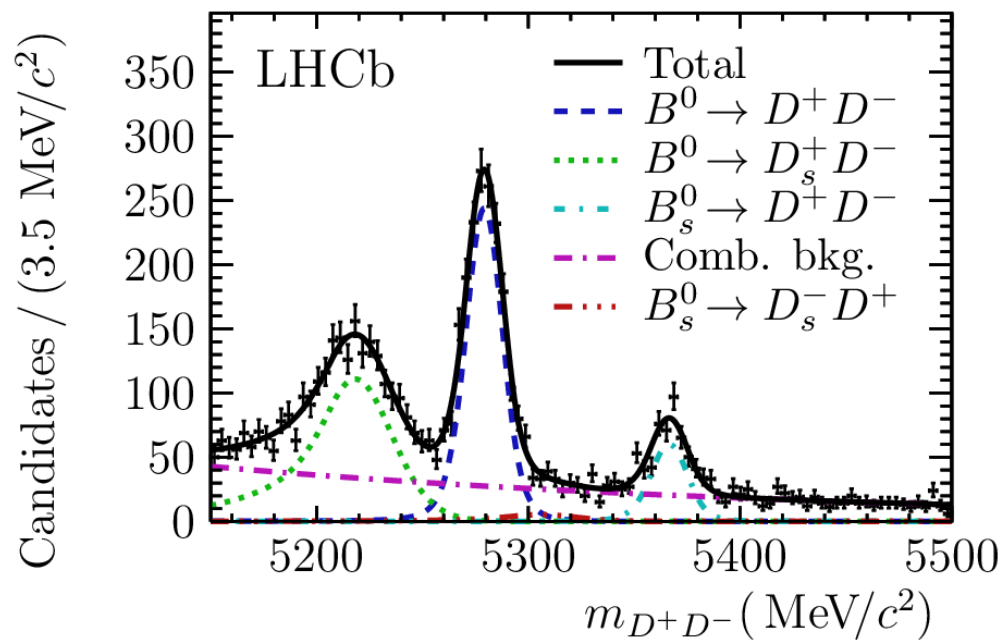

**RUN I data ( 3 fb<sup>-1</sup> )**

**1610 ± 50**

**signal candidates**

arXiv:1610.06620

# $B^0 \rightarrow D_s^+ D^-$ as control channel

- Mistag probability calibrated on  $B^0 \rightarrow D_s^+ D^-$  decays.
- Similar selection as signal, to minimize kinematic differences  
16 736  $\pm$  134 signal candidates
- Decay-time fit to  $B^0$  flavour oscillations to calibrate all taggers

$$B^0 \rightarrow D_s^+(K^+K^-\pi^+)D^-(K^+\pi^-\pi^-)$$

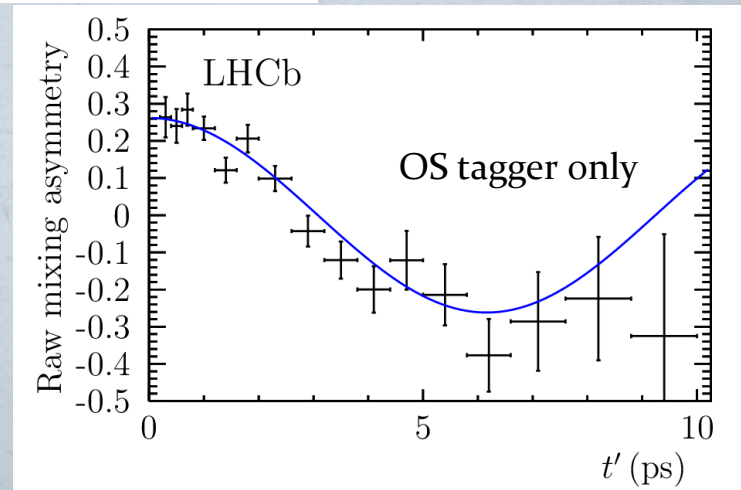
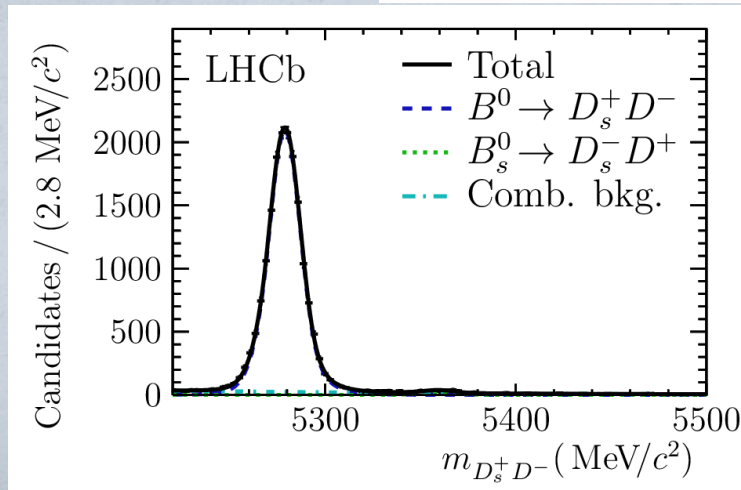

# $B^0 \rightarrow D^+D^-$ decay-time fit

$$\frac{d\Gamma(t, d)}{dt} \propto e^{-t/\tau} \left( 1 - dS \sin(\Delta mt) + dC \cos(\Delta mt) \right)$$

- Convoluted with a decay-time resolution derived from simulation ( $\sim 50$  ps) and time acceptance with free parameters

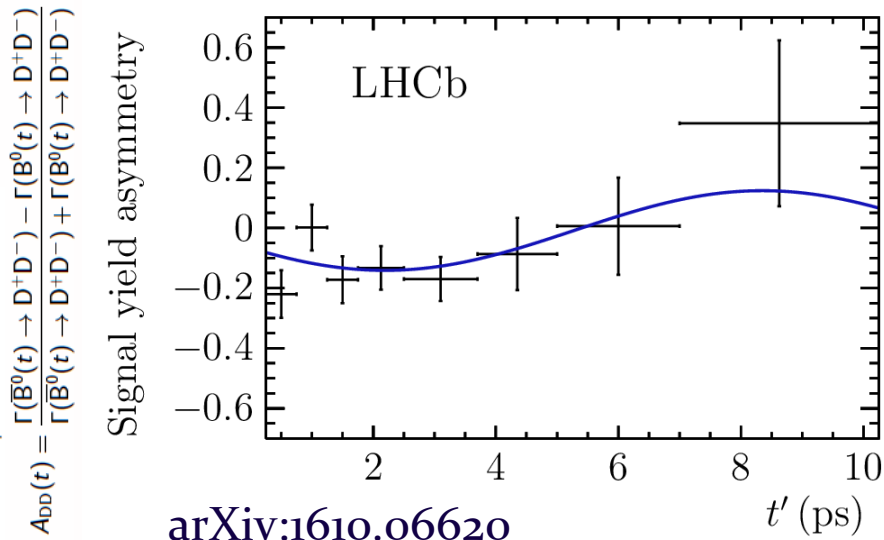
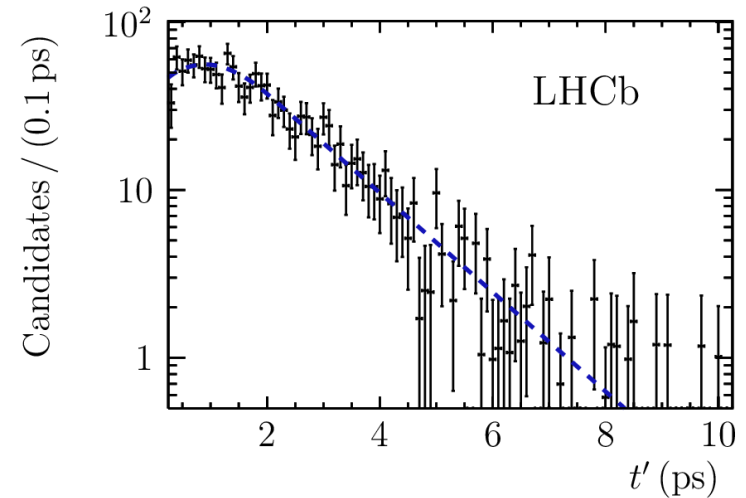

- $\varepsilon(1-2\omega)^2 = 8.1 \pm 0.6 \%$   
 $\varepsilon = 87.6 \pm 0.8 \%$     $\omega = 34.8 \pm 0.6 \%$
- High tagging power due to improved algorithms and high  $p_T$  of selected  $B^0$

$$S = -0.54^{+0.17}_{-0.16} (\text{stat}) \pm 0.05 (\text{syst})$$

$$C = 0.26^{+0.18}_{-0.17} (\text{stat}) \pm 0.02 (\text{syst})$$

Exclude CP symmetry  
conservation by  $4\sigma$

- Stat. correlation coeff.  $\rho = 0.48$ , larger than at B factories.
- **Main systematic from residual 2%  $B^0 \rightarrow D^+ K^+ K^- \pi^-$  background (assumed with maximal CP violation, opposite to signal).**
- **This result constrains the phase shift due to higher-order SM corrections to**

$$\Delta\phi = -0.16^{+0.19}_{-0.21} \text{ rad}$$

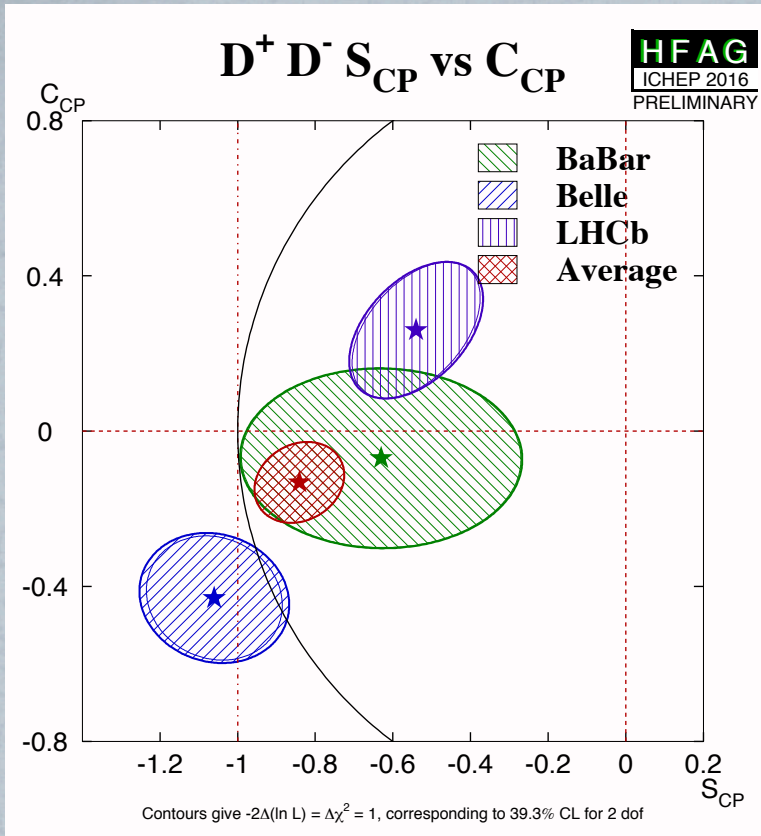

- **SU(3) symmetry relates  $\Delta\phi_d$  to  $\Delta\phi_s$**   
 **$B^0 \rightarrow D^+ D^-$  controls size of penguin contributions to  $B_s^0 \rightarrow D_s^+ D_s^-$**

Bel et al. arXiv:1505.01361,  
 Jung and Schacht arXiv:1410.8396  
 Gronau et al. arXiv:0805.4601

→ see S. Akar's talk

- LHCb result compatible with BaBar one.
- Comparison with Belle hampered by non-Gaussian uncertainties

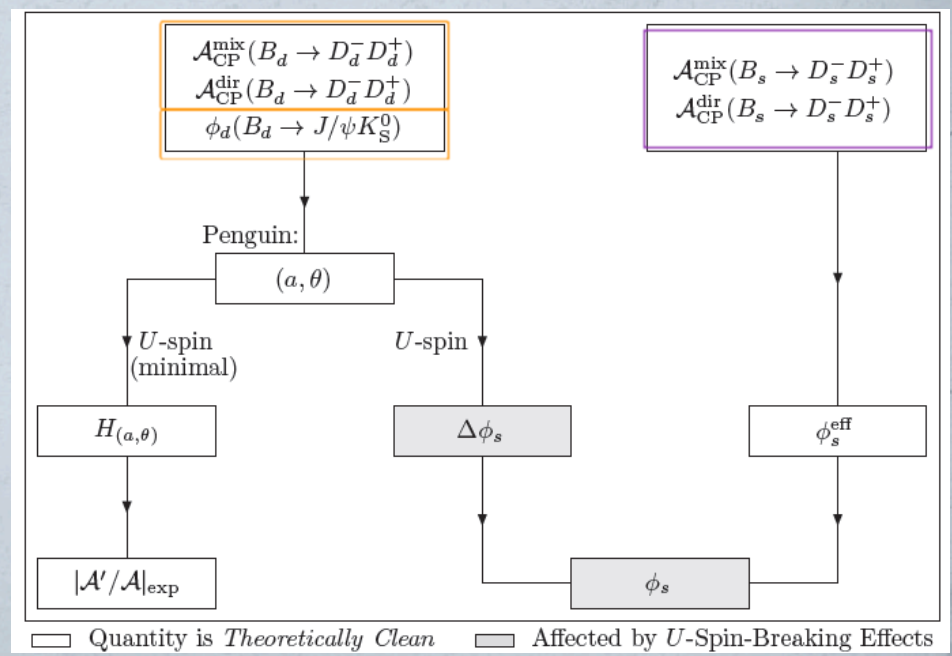



# $B^0 \rightarrow J/\psi \pi^+ \pi^-$

- Penguin contributions are predicted to be enhanced in  $B^0 \rightarrow J/\psi \pi^+ \pi^-$  wrt to  $B^0 \rightarrow J/\psi K_S$

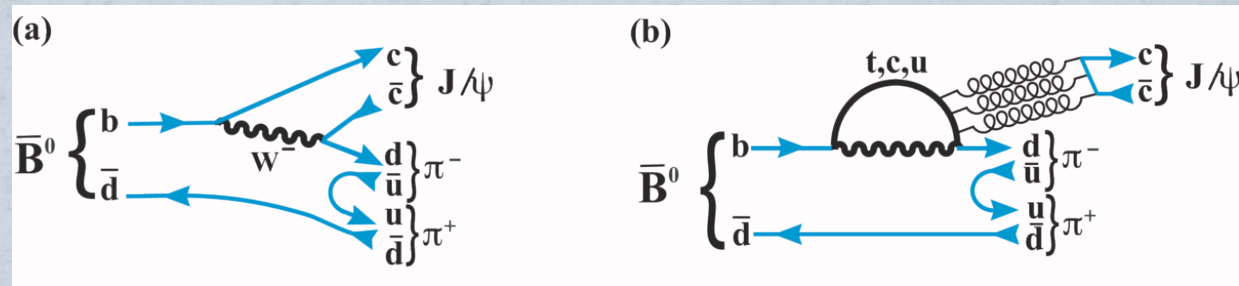

- Six resonances considered in the  $B^0 \rightarrow J/\psi \pi^+ \pi^-$  final state as in a previous amplitude analysis [Phys Rev. D 90 \(2014\) 012203](#)

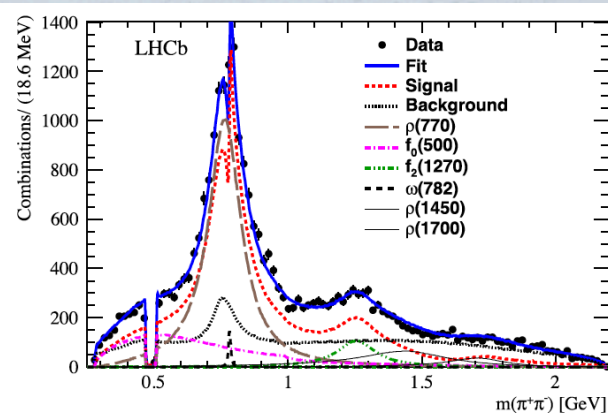
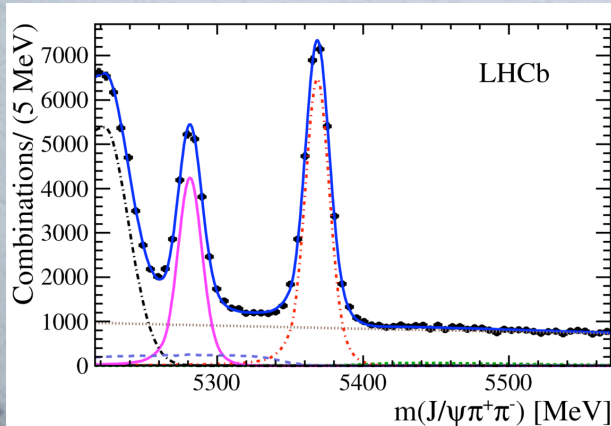

**Largest rate (~66%)  
for  $B^0 \rightarrow J/\psi \rho^0(770)$**

- **Time-dependent measurement, in each resonant final state**
  - Assume equal CP parameters for the three transversity states of  $B^0 \rightarrow J/\psi \rho^0(770)$  and a common CP parameter for all other resonances

$2\beta_i^{\text{eff}} (\circ)$	$\alpha_{CP}^i (\times 10^{-3})$	$\alpha_{CP}^i = \frac{1- \lambda_i }{1+ \lambda_i }$
$\rho$	$41.7 \pm 9.6_{-6.3}^{+2.8}$	$\rho \quad -32 \pm 28_{-7}^{+9}$
other $-\rho$	$3.6 \pm 3.6_{-0.8}^{+0.9}$	other $-1 \pm 25_{-14}^{+7}$

Phys. Lett. B742 (2015) 38

- **Difference wrt to  $B^0 \rightarrow J/\psi K_S$**

$$\Delta 2\beta_f = 2\beta^{J/\psi \rho} - 2\beta^{J/\psi K_S^0} = (-0.9 \pm 9.7_{-6.3}^{+2.8})^\circ$$

- Approximated SU(3) symmetry relates penguin contribution in  $B^0 \rightarrow J/\psi \rho^0$  and  $B_s^0 \rightarrow J/\psi \phi$  decays. Can limit the size of penguin contributions in  $B_s^0 \rightarrow J/\psi \phi$  to

$$\delta\rho = (0.05 \pm 0.56)^\circ$$

# Conclusion

- Several mixing-induced CPV measurements in  $B^0$  decays at LHCb with RUN I data
- **Charmonium:**  
 $B^0 \rightarrow J/\psi K_S$ ,  $B^0 \rightarrow J/\psi \pi^+\pi^-$ ,  $B^0 \rightarrow J/\psi K^+\pi^-$
- **Open charm:**  
 $B^0 \rightarrow D^+ D^-$ ,  $B^0 \rightarrow D^+ \pi^-$  (see A. Birnkraut's talk)
- Exciting prospects with new RUN II data and improved analysis techniques.
- Higher trigger efficiency for hadronic modes will also come with LHCb Upgrade

backup

**Table 8**Comparison of  $S_f$  and  $C_f$  between different measurements.

Experiment	$f$	$S_f$	$C_f$
LHCb	$\overline{B}^0 \rightarrow J/\psi \rho^0$	$-0.66^{+0.13+0.09}_{-0.12-0.03}$	$-0.063 \pm 0.056^{+0.019}_{-0.014}$
Belle [33]	$\overline{B}^0 \rightarrow J/\psi \pi^0$	$-0.65 \pm 0.21 \pm 0.05$	$-0.08 \pm 0.16 \pm 0.05$
BaBar [34]	$\overline{B}^0 \rightarrow J/\psi \pi^0$	$-1.23 \pm 0.21 \pm 0.04$	$-0.20 \pm 0.19 \pm 0.03$

Phys. Lett. B742 (2015) 38