

Advances in Neutrino Detection

Milind Diwan

Colloquium at Tata Institute of Fundamental Research
Jan. 4, 2018

Plan of lecture

- Basics of Radiation Detectors
- Basics of Neutrino Sources and Interactions.
- Particle signatures in matter.
- Basic components of detectors.
- Neutrino detector types. Some examples as time permits.
- This lecture is very much meant for technologists and engineers. I have skipped the physics on purpose !

Although this is from the point of view of neutrino detection, most of the techniques are common in all radiation detection.

Some Basics

- **We can only measure 4 quantities and their combinations:**

- **Distance (units are meters)**
- **Time (units are seconds)**
- **Mass (units are kilogram)**
- **Electric Charge (coulomb)**

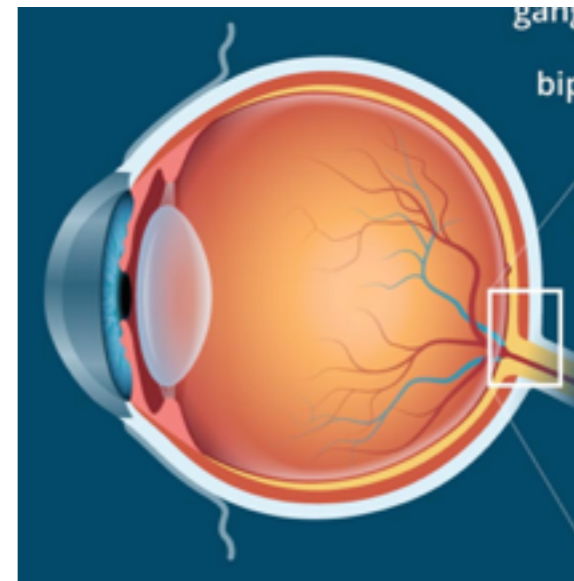

Example

- **All detectors are built on the principle of charge detection.**
- **Any effect must be first be converted to free electric charge or motion of charge to be detected.**
- **This is regardless of whether detecting light, neutrinos, or gravitational waves.**

Neutrino Detection

- *Neutrinos are very light particles with no electrical charge.*
- *They cannot stick together or to other ordinary things.*
- *Just like photons, the signature of neutrinos must be first be converted into electrical particles before we can detect them.*
- *There are hundreds of billions of neutrinos passing through us every second. These come from the Sun.*
- *The universe has almost as many neutrinos as particles of light. There are about 400 particles of light in every cm-cubed. There are almost as many neutrinos.*

Some history

- ***By 1930 many confusing results concerning nuclear structure***
 - ***Quantum Mechanics established. BUT***
 - ***Spin and statistics of odd mass number (A) nuclei is always half integer; this is wrong if made of electrons and protons.***
 - ***Nuclear spin is integer for all even A and half-integer for odd A .***
 - ***Secondly, why is the beta spectrum from the nucleus continuous and not quantized ? It can only be continuous if something else is getting emitted to conserve energy.***



The experimental results and the understanding of the quantum mechanics could only mean either

1) No event by event energy conservation

or

2) Another penetrating particle.

Pauli proposes a particle

The letter in which Pauli proposed the neutrino, translated from the German of reference 5, reads as follows:

Zürich, 4 December 1930
Gloriastr.

Physical Institute of the
Federal Institute of Technology (ETH)
Zürich

Dear radioactive ladies and gentlemen,

As the bearer of these lines, to whom I ask you to listen graciously, will explain more exactly, considering the "false" statistics of N-14 and Li-6 nuclei, as well as the continuous β -spectrum, I have hit upon a desperate remedy to save the "exchange theorem" * of statistics and the energy theorem. Namely [there is] the possibility that there could exist in the nuclei electrically neutral particles that I wish to call neutrons, which have spin $\frac{1}{2}$ and obey the exclusion principle, and additionally differ from light quanta in that they do not travel with the velocity of light: The mass of the neutron must be of the same order of magnitude as the electron mass and, in any case, not larger than 0.01 proton mass.—The continuous β -spectrum would then become understandable by the assumption that in β decay a neutron is emitted together with the electron, in such a way that the sum of the energies of neutron and electron is constant.

Now the next question is what forces act upon the neutrons. The most likely model for the neutron seems to me to be, on wave mechanical grounds (more details are known by the bearer of these lines), that the neutron

at rest is a magnetic dipole of a certain moment μ . Experiment probably requires that the ionizing effect of such a neutron should not be larger than that of a γ ray, and thus μ should probably not be larger than $e \cdot 10^{-13}$ cm.

But I don't feel secure enough to publish anything about this idea, so I first turn confidentially to you, dear radioactives, with the question as to the situation concerning experimental proof of such a neutron, if it has something like about 10 times the penetrating capacity of a γ ray.

I admit that my remedy may appear to have a small *a priori* probability because neutrons, if they exist, would probably have long ago been seen. However, only those who wager can win, and the seriousness of the situation of the continuous β -spectrum can be made clear by the saying of my honored predecessor in office, Mr. Debye, who told me a short while ago in Brussels, "One does best not to think about that at all, like the new taxes." Thus one should earnestly discuss every way of salvation.—So, dear radioactives, put it to the test and set it right.—Unfortunately I cannot personally appear in Tübingen, since I am indispensable here on account of a ball taking place in Zürich in the night from 6 to 7 of December.—With many greetings to you, also to Mr. Back, your devoted servant,

W. Pauli

* In the 1957 lecture, Pauli explains, "This reads: exclusion principle (Fermi statistics) and half-integer spin for an odd number of particles; Bose statistics and integer spin for an even number of particles."

Aside

- *In the summer of 1930 a young man of 20 was traveling to UK on a boat and thinking about the stability of stars.*
- *He predicted through pure reasoning that stars cannot remain stable if they have mass of >1.44 of the Sun.*
- *Such stars eventually implode emitting huge numbers of neutrinos; supernova.*
- *Remember that neutrinos and neutrons were unknown at that time. Imagine the courage it took to for him to be sure of himself.*



**Subrahmanyan
Chandrasekhar**

EVOLUTION OF STARS

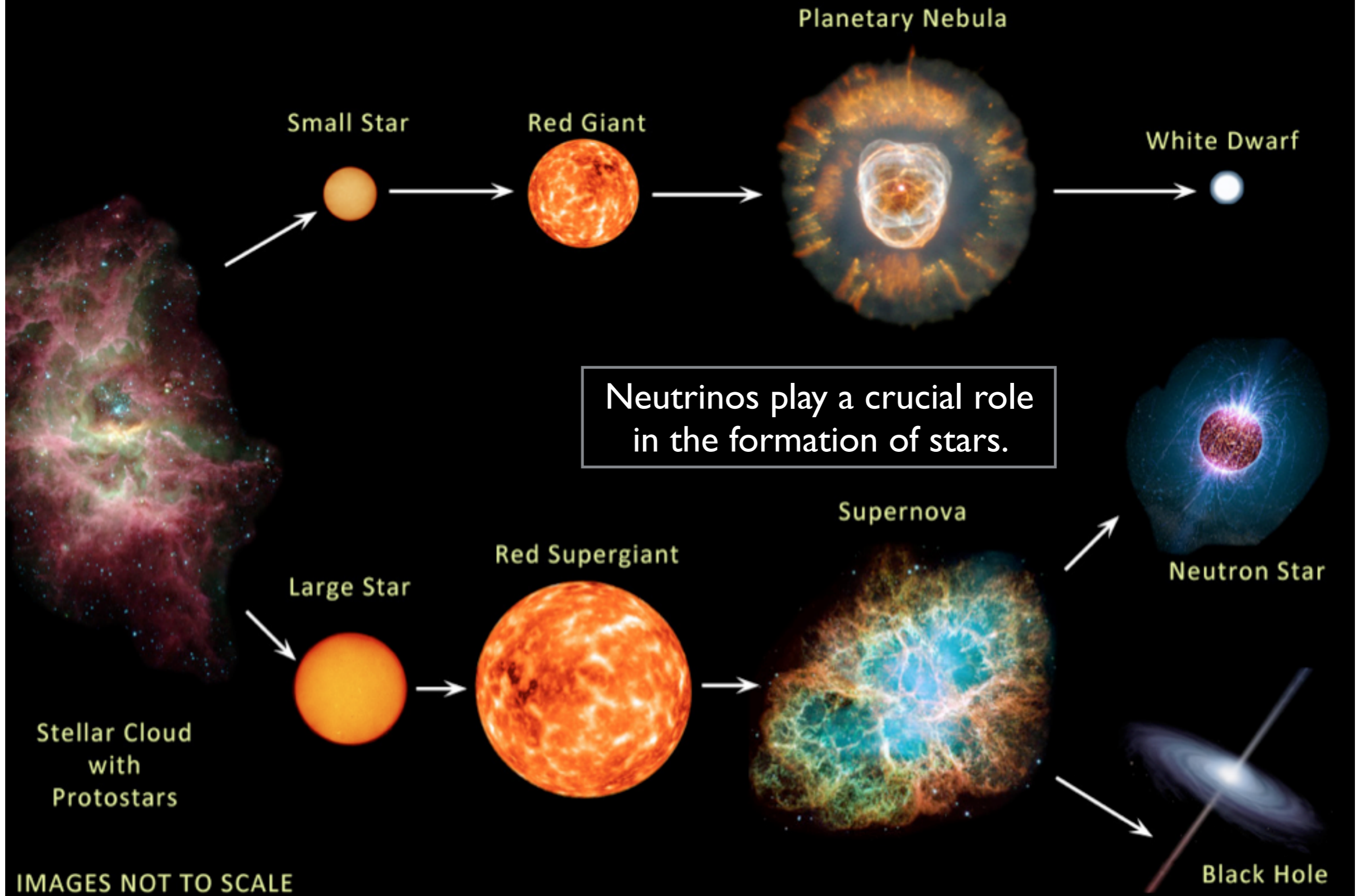

IMAGES NOT TO SCALE

Weak interaction

- *Radioactivity (beta decay) is a process that converts ordinary charged matter inside nuclei into neutrinos.*
- *There is “inverse radioactivity” that converts neutrinos into charged particles.*
- *Both of these are called weak interactions because they are rare.*

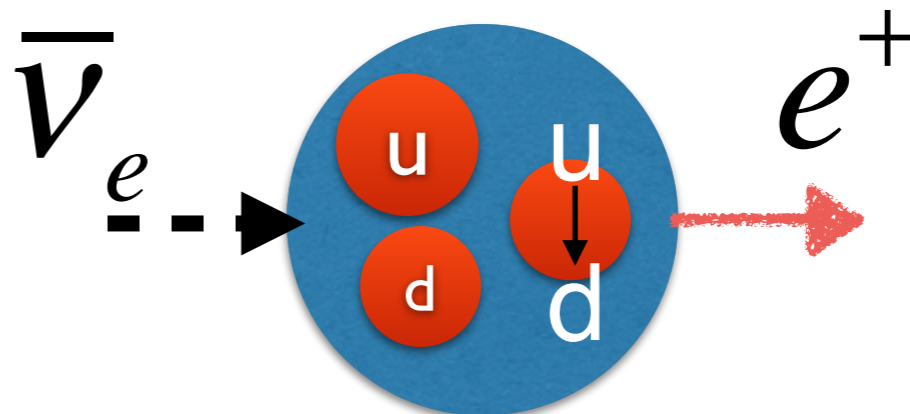
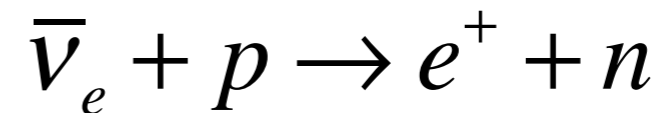
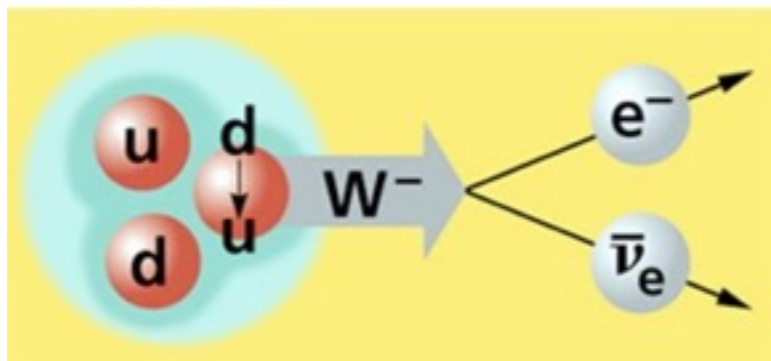

Neutrino Detection for 3 types of neutrinos

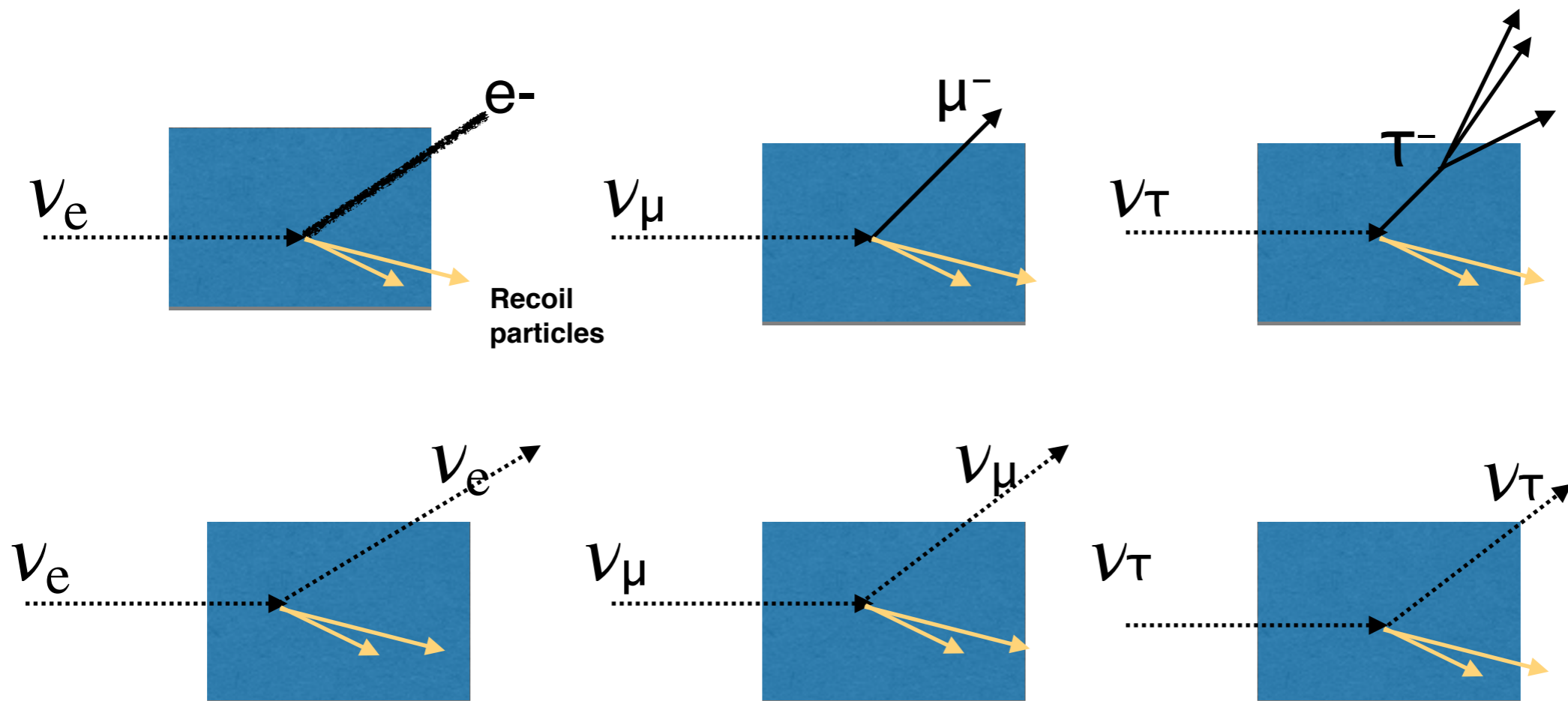

- *The neutrino is invisible as it enters a detector. Rarely interacts and leaves charged particles that can be detected.*
- *Neutrino collision on atoms in detectors produces a charged lepton. **The electron, muon, tau have very different signatures in a detector.***
- *Neutrino can also collide and scatter away leaving observable charged particles. (Neutral Current)*

Cross section for particle collisions

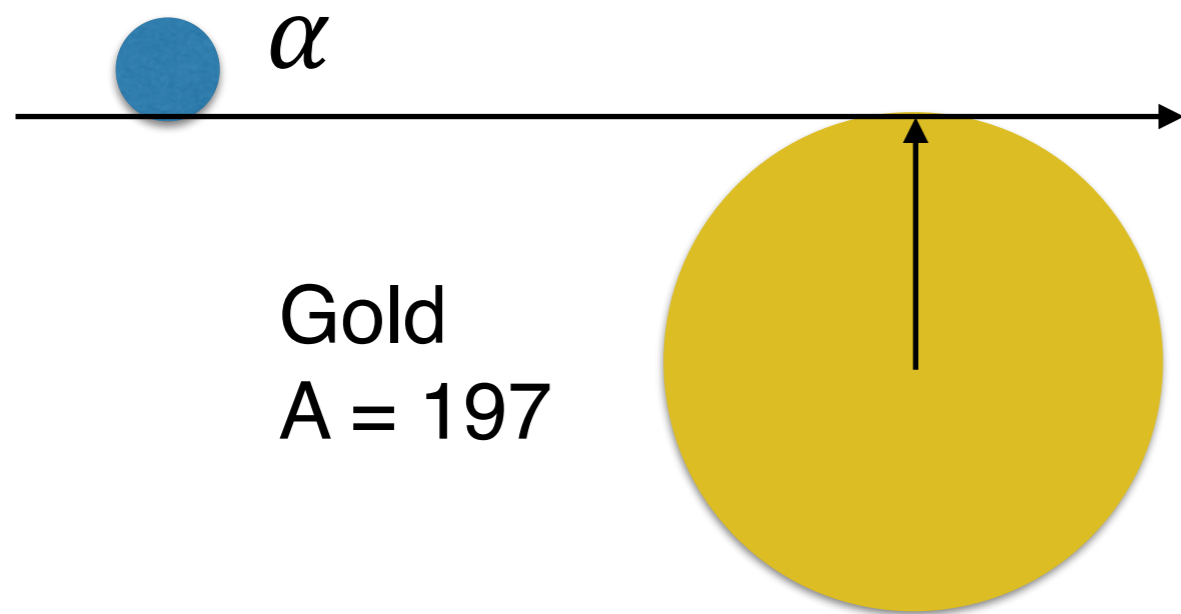

Radius of a gold nucleus is

$$R = 1.2 \times \sqrt[3]{197} \text{ fm} = 7 \text{ fm}$$

fm is 10^{-15} m

Cross section for alpha particle is then

$$\sigma \approx \pi R^2 \approx 1.5 \times 10^{-24} \text{ cm}^2$$

In particle physics, the cross section between any two particles is the area transverse to their relative motion within which they must meet in order to interact. It is the effective size.

More about cross section

- *Quantum physics is very strange. There are no hard spheres and the cross section depends on many things:*
 - *The two types of particles. (alpha and Gold ...)*
 - *Their spin orientation if any.*
 - *Their relative velocities.*
 - *The type of interaction that they exhibit: electrical, weak, or strong !*

Neutrinos have extremely small cross section. Even for Neutrino on Gold.

**Neutrino Cross sections are extremely small $\sim 10^{-38} \text{ cm}^2/\text{GeV}$
 To a neutrino a Gold nucleus is smaller by ~ 12 orders of mag.**

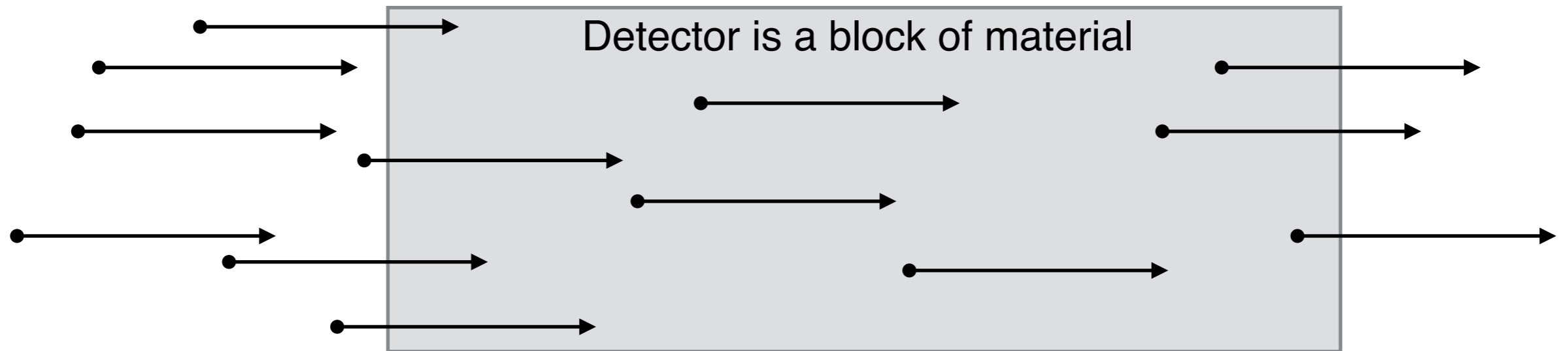

As particles penetrate material, there is a reduction in the flux (particle/area/sec)

$$F(x) = F(0)e^{-\sigma\rho x}$$

$$\lambda = 1 / (\sigma\rho)$$

λ is the mean free path

σ is the cross section

ρ is the density of targets

(In water $\rho \sim 6 \times 10^{23} \text{ cm}^{-3}$)

For 1 GeV neutrino interactions $\sigma \sim 10^{-38}$ and

$$\lambda = \frac{1}{10^{-38} \cdot 6 \times 10^{23}} \approx 10^{12} \text{ meters!}$$

In ordinary matter neutrinos just penetrate through with very rare interactions.

How to calculate neutrino event rate ?

- ***Events = Flux (/cm²/sec)*Cross-section(cm²)*Targets***
- **Targets are the number of particle targets in a detector volume. Detector itself serves as the target for interactions.**
- **1 ton of anything has $\sim 6 \times 10^{29}$ protons and neutrons and**
- **1 ton of anything has $\sim 3 \times 10^{29}$ electrons**
- **Typical cross section is $10^{-38} \text{ cm}^2 \times \text{Energy (in billion eV)}$**
- **Neutrinos have huge energy range: eV to 10^{15} eV.**
- **Cross sections for low energies can be extremely small.**
- ***1 eV = Energy to move 1 electron through 1V = 1.6×10^{-19} Joule***
- ***Proton mass is ~ 1 billion eV = 1 GeV. Electron mass ~ 0.511 MeV***

Cosmic Rays

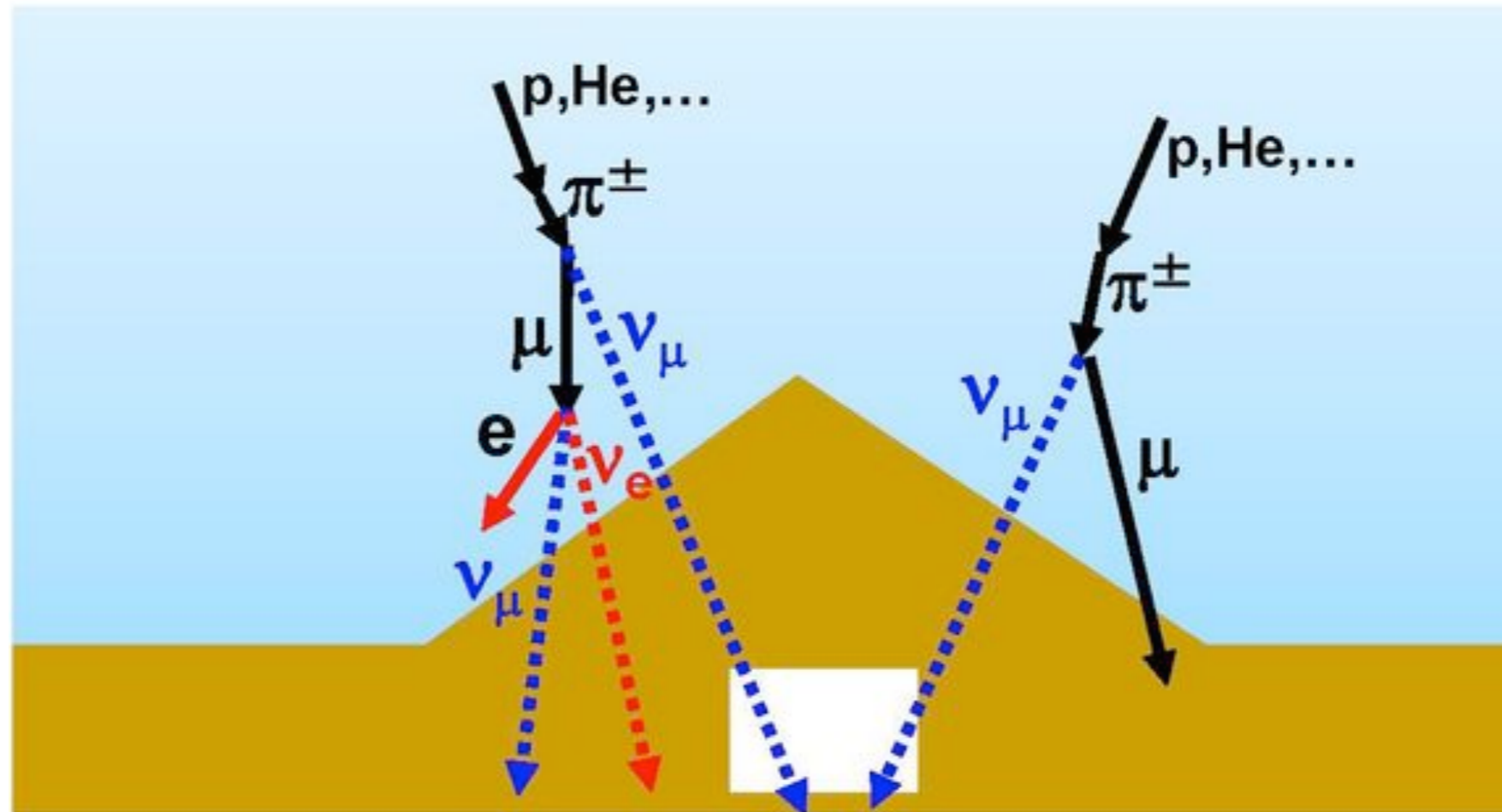

Primary cosmic rays (protons, He, etc) come from outer space and strike atoms in the upper atmosphere. From these there is a cascade of particles that decay in flight to produce **atmospheric muons and neutrinos. Muons are charged.**

There should be 3 neutrinos for each muon of either charge).

Ratio of neutrinos (e-type/mu-type) = 1/2

From high altitude muon data one can roughly calculate neutrino flux ~ 5000 /m²/sec

$\sim 250 * 2 \text{ Pi} * 3$

Detector mass needed for 1000 evts/yr ?

$$\varphi = 5000 \text{ m}^{-2} \text{ sec}^{-1}$$

$$E \sim 1 \text{ GeV}$$

$$\sigma \sim 10^{-38} \text{ cm}^2$$

$$\text{Nucleons} = 6 \times 10^{29} \text{ ton}^{-1}$$

$$N = \varphi \cdot \sigma \cdot 6 \times 10^{29} \cdot 3 \times 10^7 \text{ ton}^{-1} \text{ yr}^{-1}$$

$$N = 0.1 \text{ events / ton / yr}$$

**Example using
Atmospheric
Neutrinos**

- ***The first most important consideration for neutrino detection is the mass of the detector. (thousands of tons are needed for many experiments).***
- ***If flux is high, mass can be lowered.***
- ***Both Energy and Flux need to be known.***

Discovery of atmospheric neutrinos

The discovery of the first atmospheric neutrinos was in India in the Kolar Gold Fields Experiment. This is a TIFR discovery !

(C. V.Achar et al., Detection of muons produced by cosmic ray neutrinos deep underground, Phys. Lett. 18 (1965) 196)

The detector was very deep underground (7600 ft) to eliminate cosmic ray muons.

If a muon was seen to go horizontally thru the detector, it was very likely from a neutrino and not a cosmic muon. (they saw 3 events)

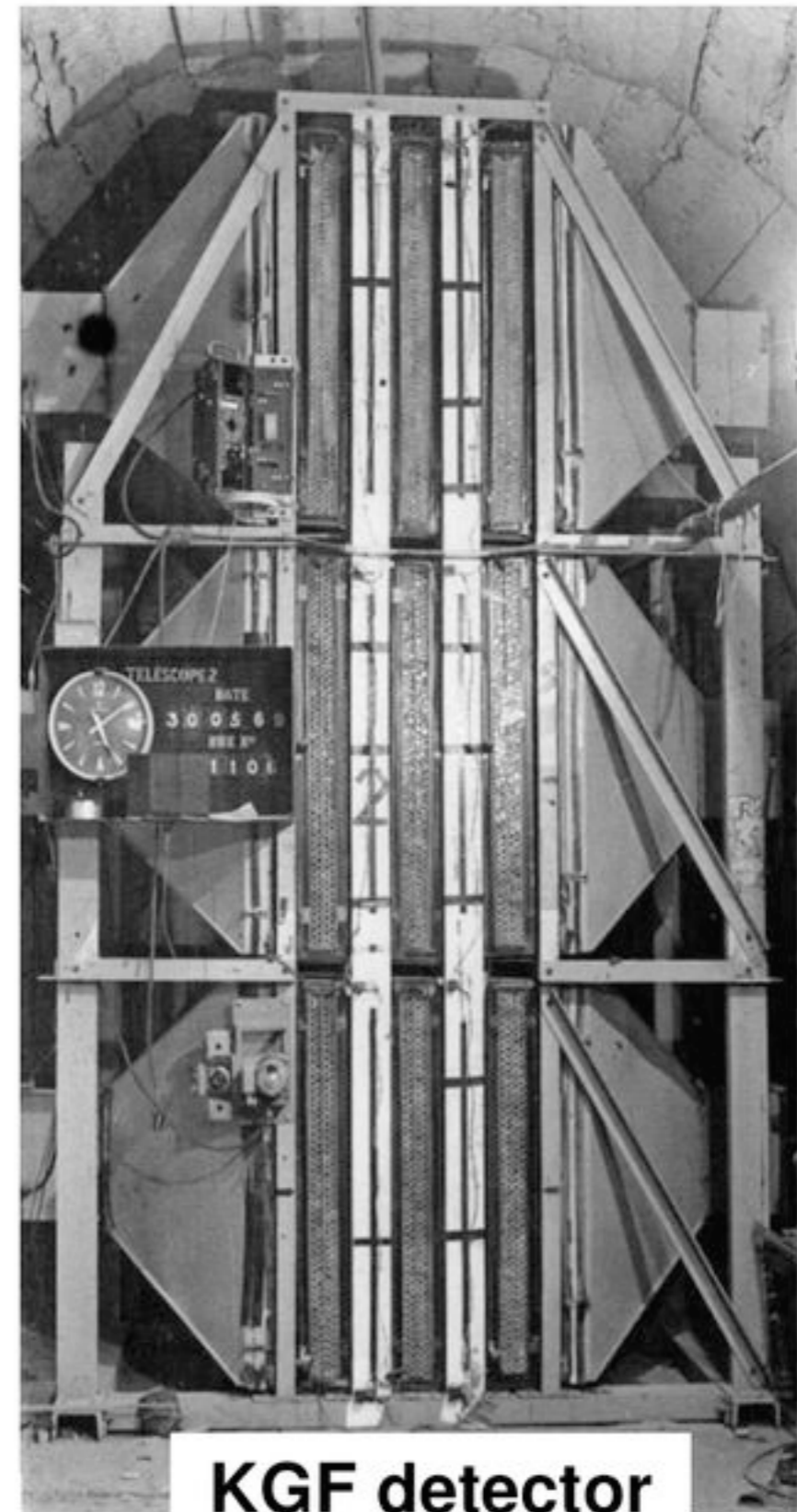

3 meter

80 cm

Neutrino

Other particles

Rock

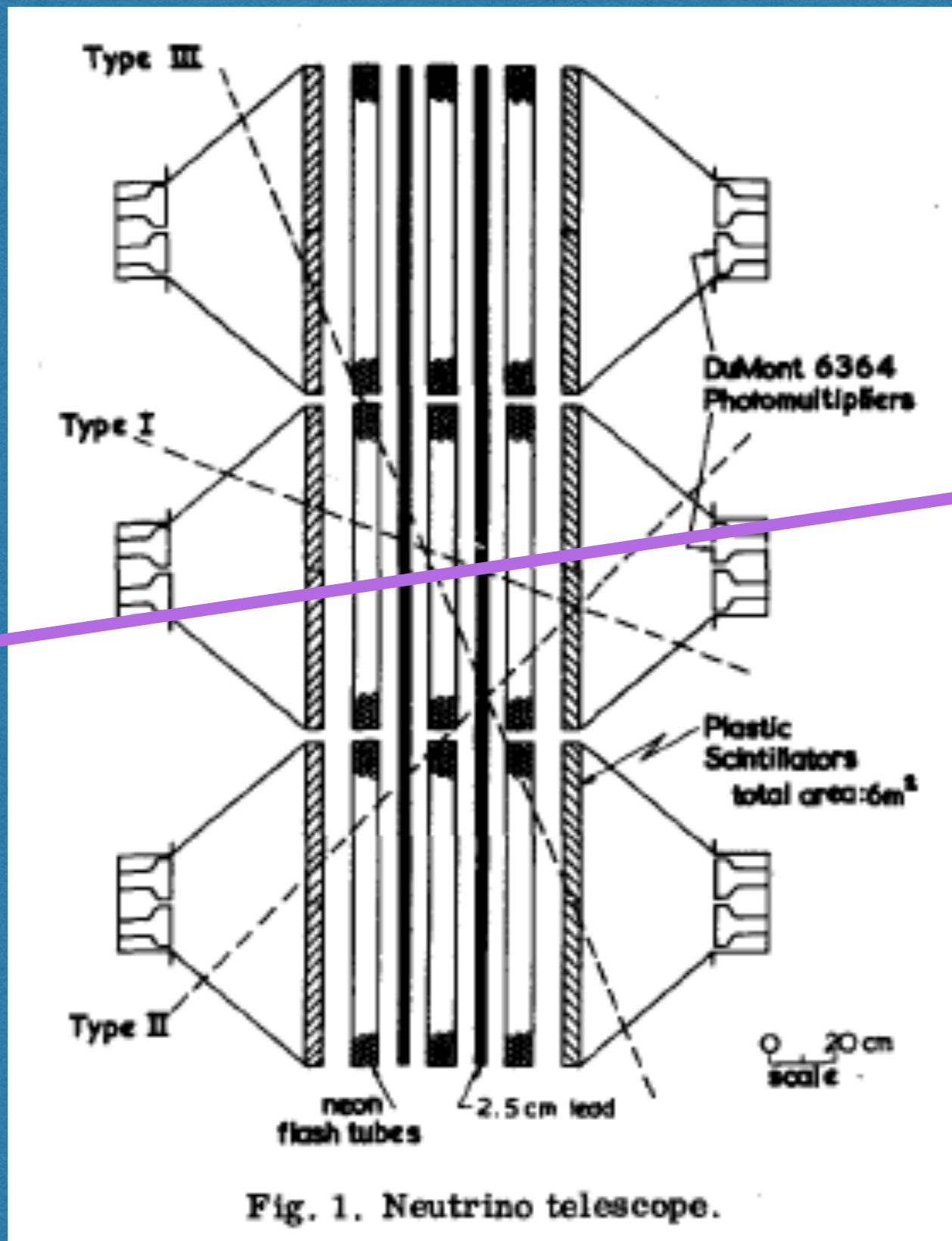

Penetrating MUON

Typical Neutrino Detector Technologies

Material	Composition	Density	Signal type	Comment
Water/Ice	H ₂ O	1.0	Cherenkov Light	Can be huge
Liquid Scintillator	~CH ₂	~0.9	Scintillation Light	Low energy Threshold
Plastic Scintillator	~CH ₂	~0.9	Scintillation Light	Segmented
Steel planes	Fe	~7.8	Scint./Gas chambers	Magnetized
Liquid Argon	Ar	1.4	Charge/Scintillation	Can be very fine grained
Radiochemical	Ga, C ₂ Cl ₄ , In	Depends on technology	Induced Radioactivity	Extremely Low Thresholds
Water-based Scintillator	H ₂ O+ εCH ₂	1.0	Cherenkov + Scint.	Huge with low threshold

Given the emphasis on detector mass, we must choose materials that are inexpensive and produce a signature that can be easily measured by common sensors. There are many clever schemes for sensors.

Cosmic Ray backgrounds

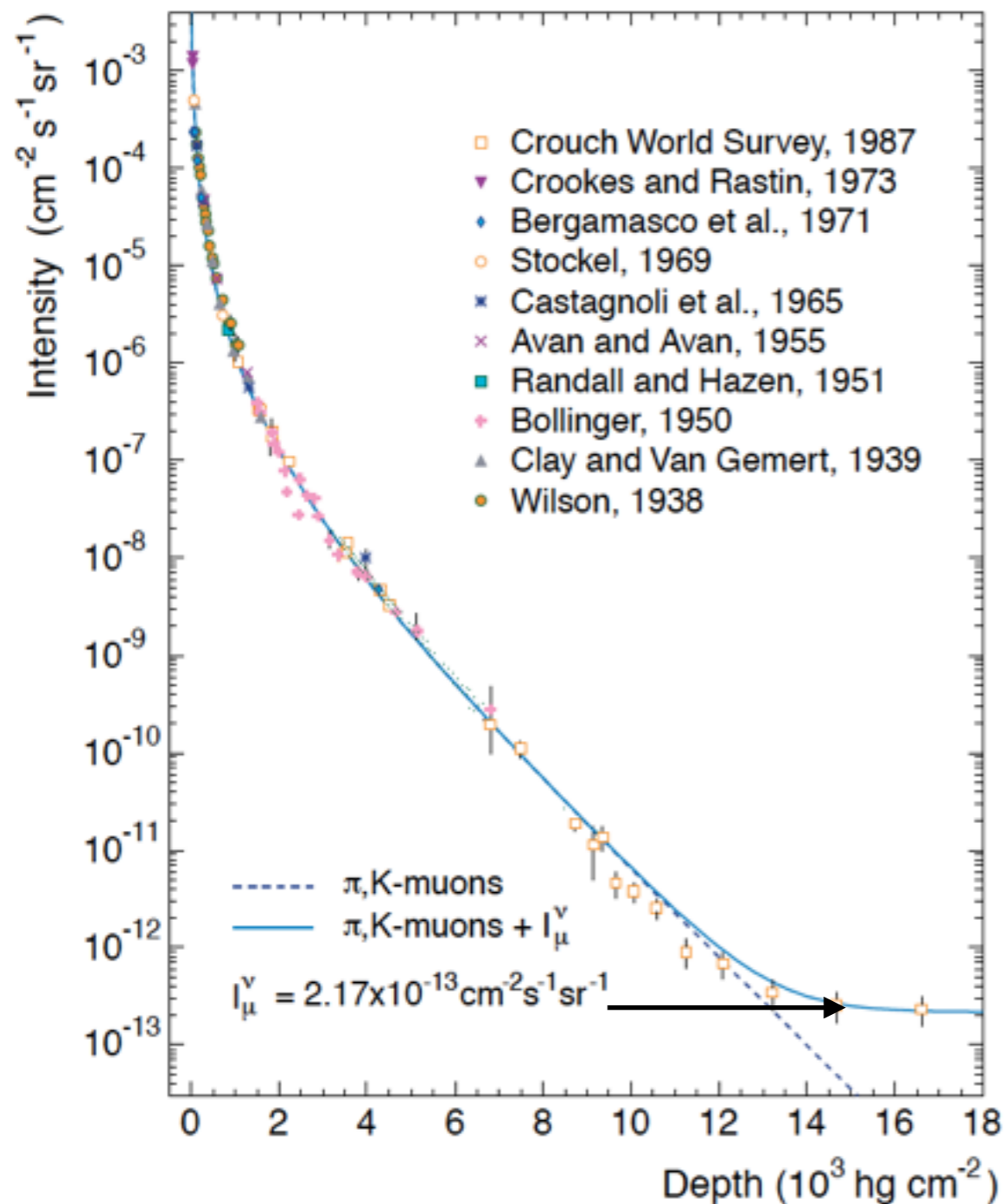

This axis is approximately km of water depth

$1 \text{ km.w.e} = 10^5 \text{ g cm}^{-2}$ of standard rock

- *Central issue in neutrino detection is background from cosmic rays; reduced by overburden or depth.*
- *The needed depth depends on the physics signals.*
- *The spectrum of muons at shallow depth is \sim few GeV with $\text{Cos}^2\theta$ distribution. At surface $\sim 70 \text{ Hz/m}^2$*
- *Beyond $\sim 2 \text{ km}$, the spectrum is constant around $\sim 300 \text{ GeV}$ and the angular distribution becomes steeper.*
- *For very low energies cosmogenic neutrons are important.*

Let's now look at some data



***It would be impossible
to see a neutrino
interaction in this !***

Cosmic ray cloud chamber at the New York Hall of Science

The surface rate is $\sim 100 \text{ m}^{-2}\text{sec}^{-1}\text{sr}^{-1}$

Mean $\sim 4 \text{ GeV}$

Flat below 1 GeV. $E^{-2.7}$ above 10 GeV.

Angular $\sim \text{Cos}^2(\text{Theta})$

Summarize so far

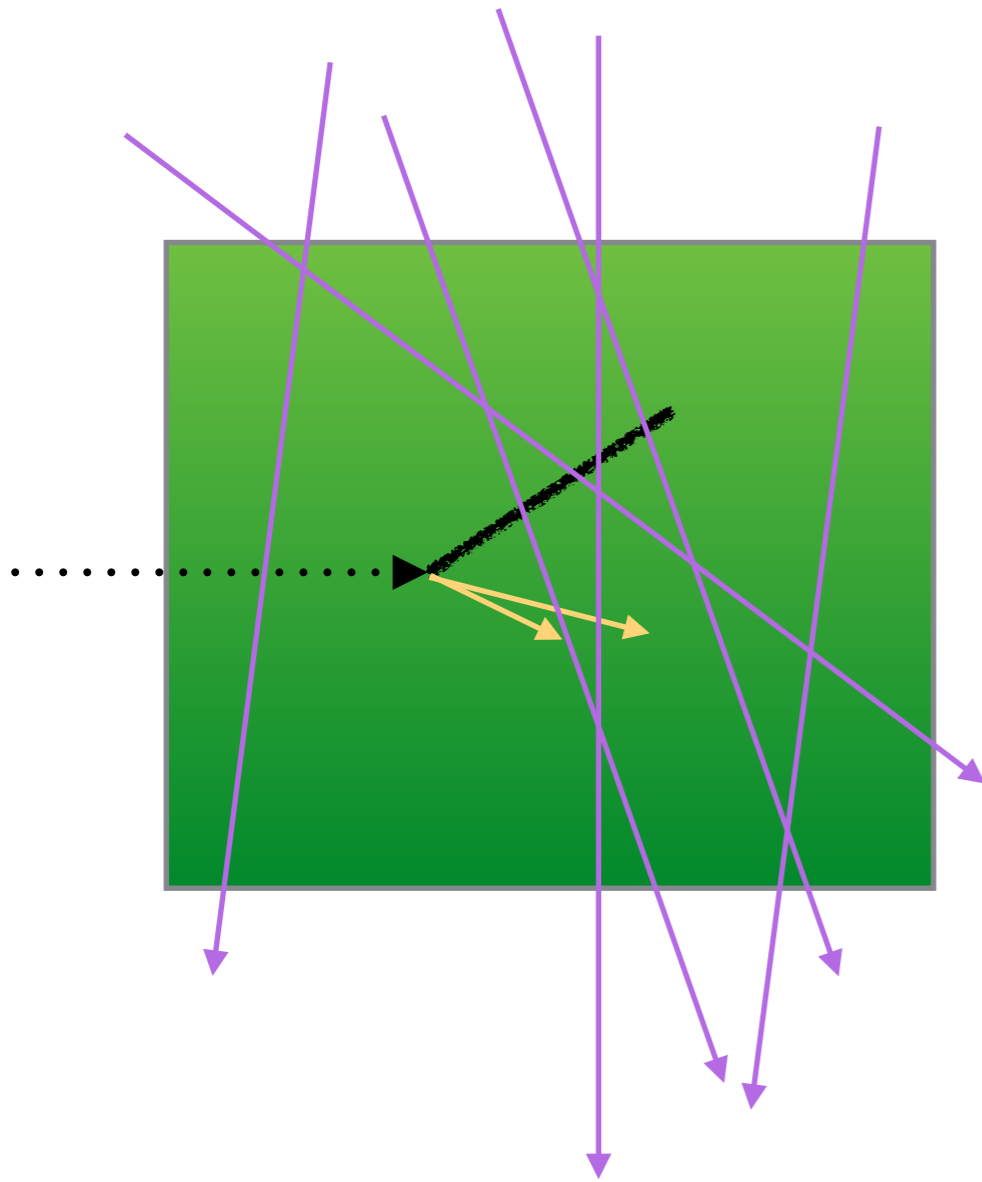

- *Neutrinos interact in blocks of material and leave energetic charged particles. These are rare events !*
- *We must find these rare neutrino events in the presence of cosmic rays that penetrate all the time.*
- *The signature of neutrino interactions are different for different energies and neutrino type.*
- *How do we register the deposited charged particles in our electronics ?*

Signatures of charged particle energy loss

- *Ionization related processes:*
 - *Most of the energy loss of fast charged particles is due to single collisions with atomic electrons. In most collisions energy W is lost with $W < 100$ eV.*
 - *The energy loss has a minimum and rises very quickly as particle slows.*
 - *This lost energy causes 1) free electric charge, 2) scintillation light, 3) physical (bubbles) and chemical changes (photographic plates).*
- *Cherenkov radiation: happens when particle moves faster than speed of light in a medium. This is used with gas, acrylic, and water.*
- ***IN ANY CASE, WE MUST MEASURE EITHER LIGHT IN A SENSOR OR MEASURE CHARGE DIRECTLY.***

Photo-Multiplier Tube

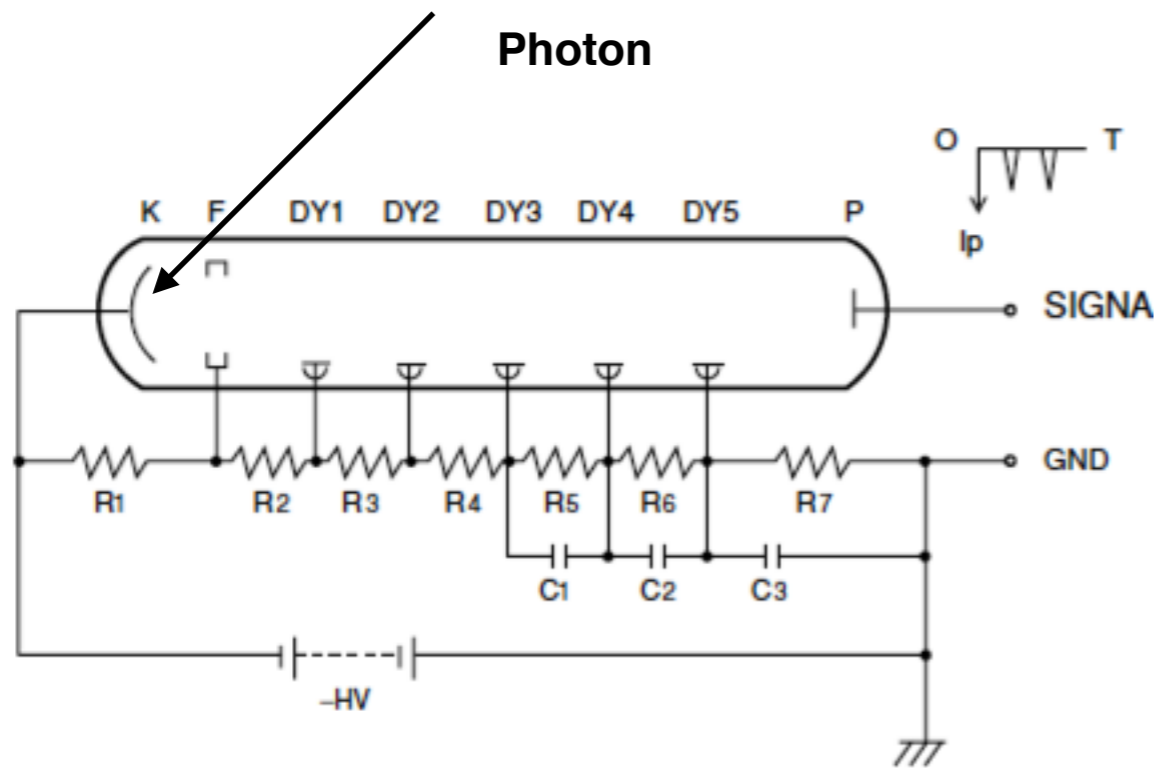

- *Photons are converted to charge by a photocathode with low work function.*
- *Electric fields accelerate and multiply the primary electron in several stages. Each stage has multiplication of $\sim 4-5$.*
- *Gain can be few 10^6*
- *There are Many clever geometries.*
- *New types of photon sensors are always being developed.*

Ionization detectors

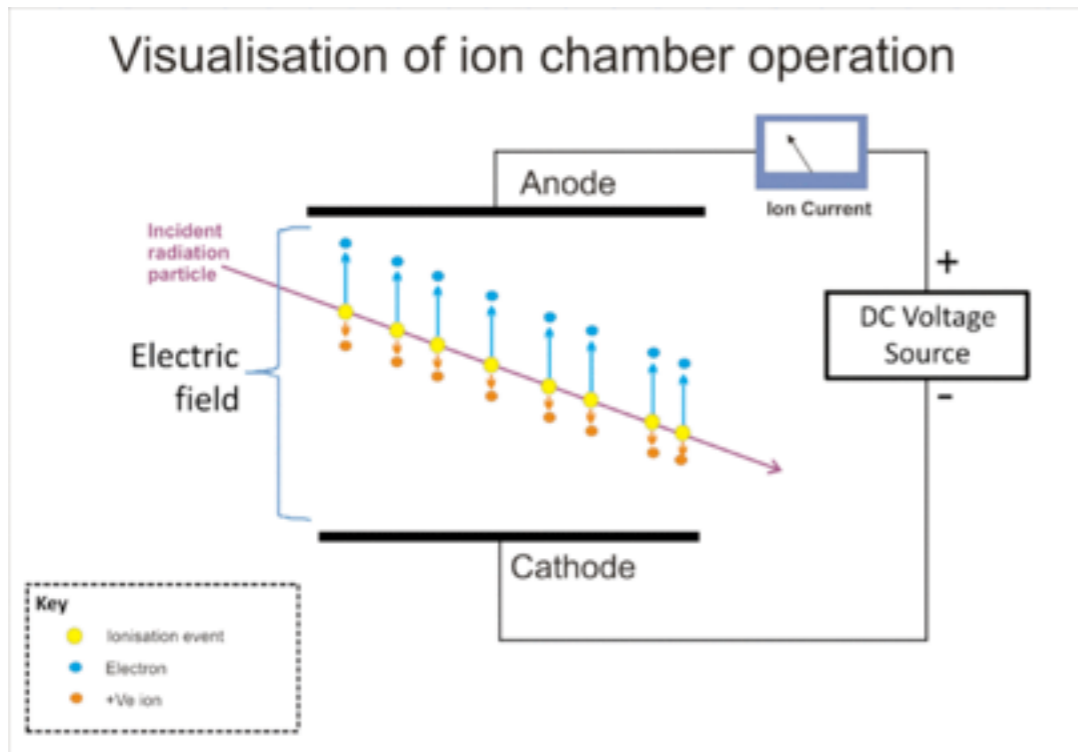

material	W (ev/pair)
LAr	23.6
LXe	15.6
Silicon	3.6
Germanium	2.9
Diamond	~13
CdTe	5.2
LNe	36
LKr	19

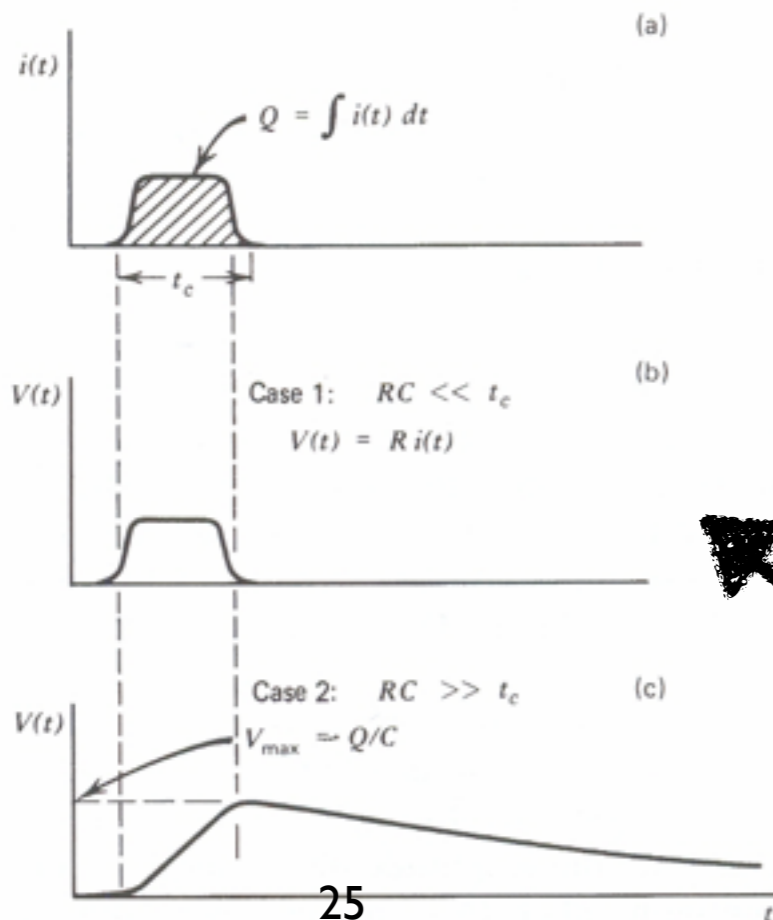

- In gases, semiconductors, and pure insulators, ionization creates electron-ion pairs.
- Electrons generally move about 1000 times faster than ions.
- This current can be measured as voltage across a resistor (case 1) or pulse across a capacitor (case 2)

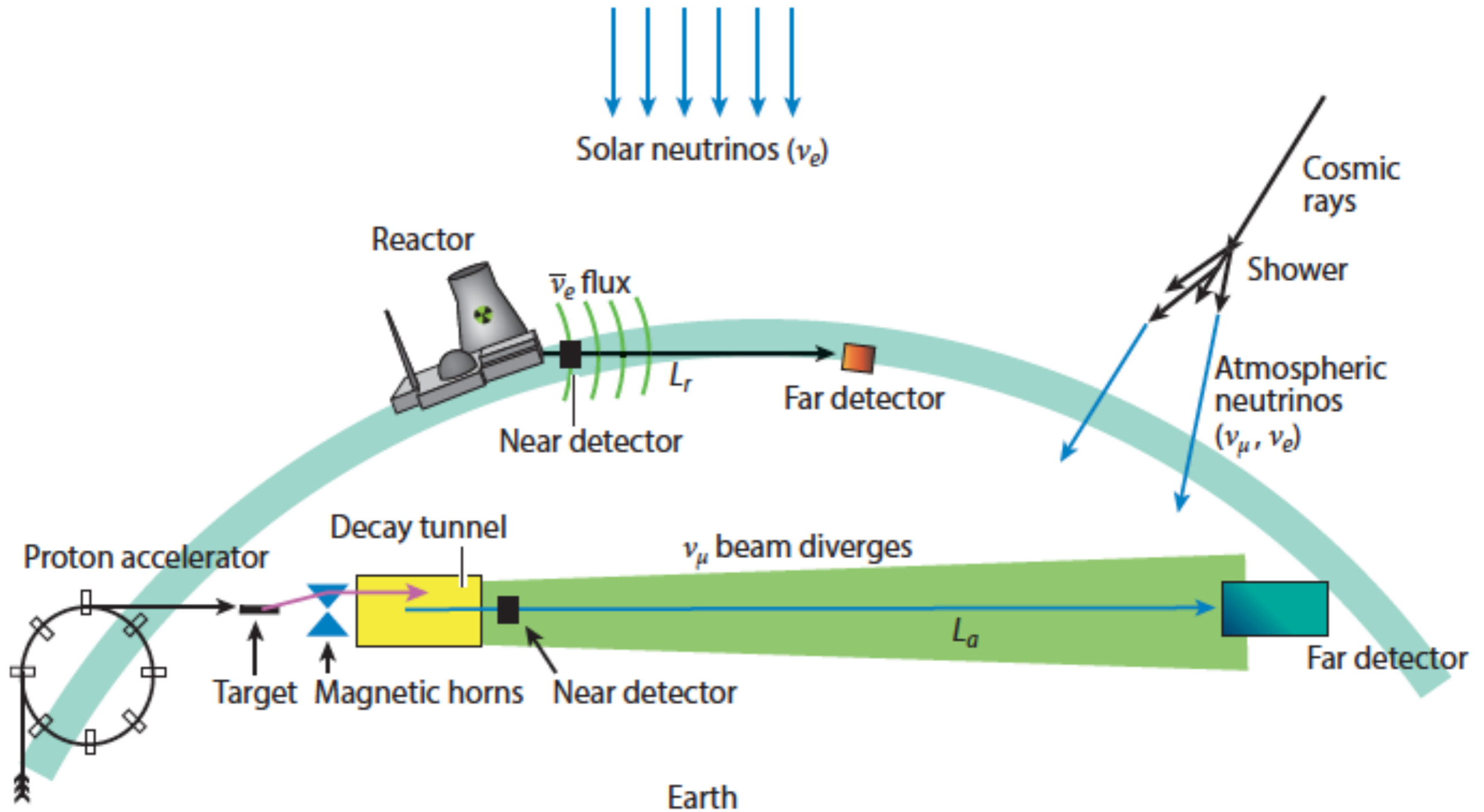

Sources of data for neutrino experiments.
 Atmosphere, Solar, Accelerator, Reactor.

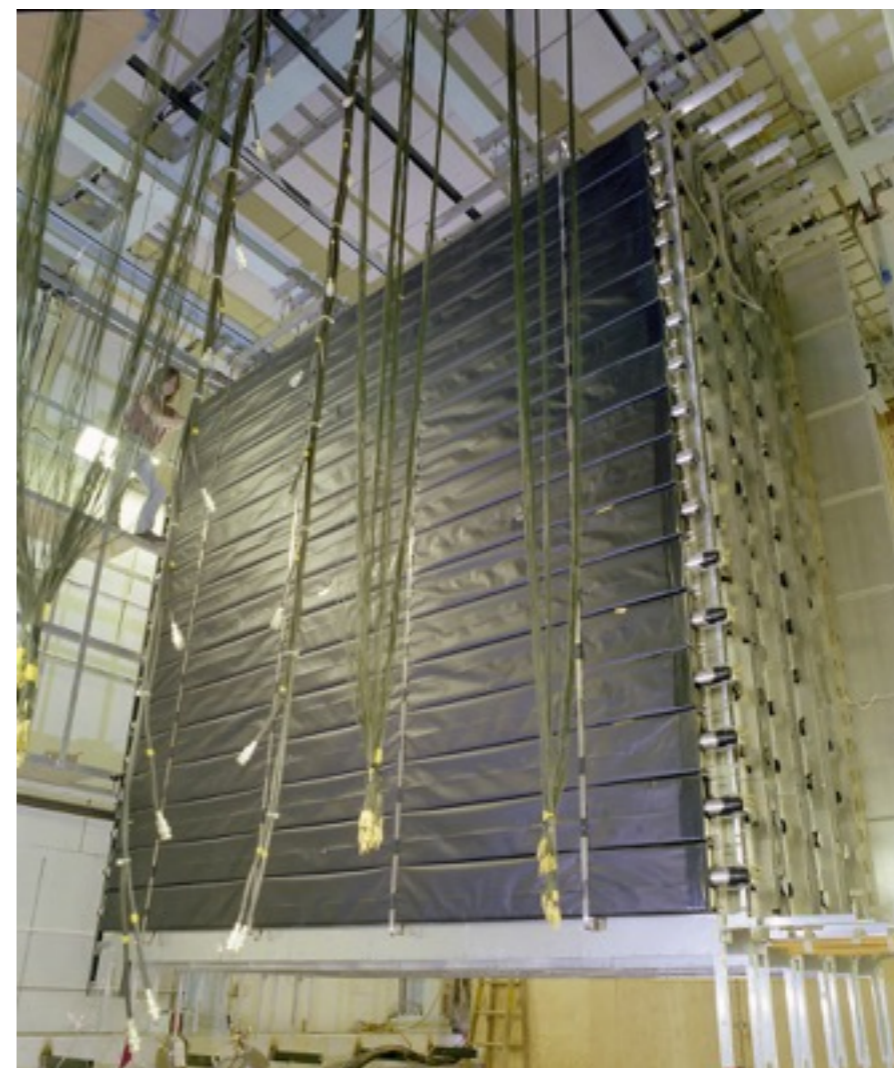
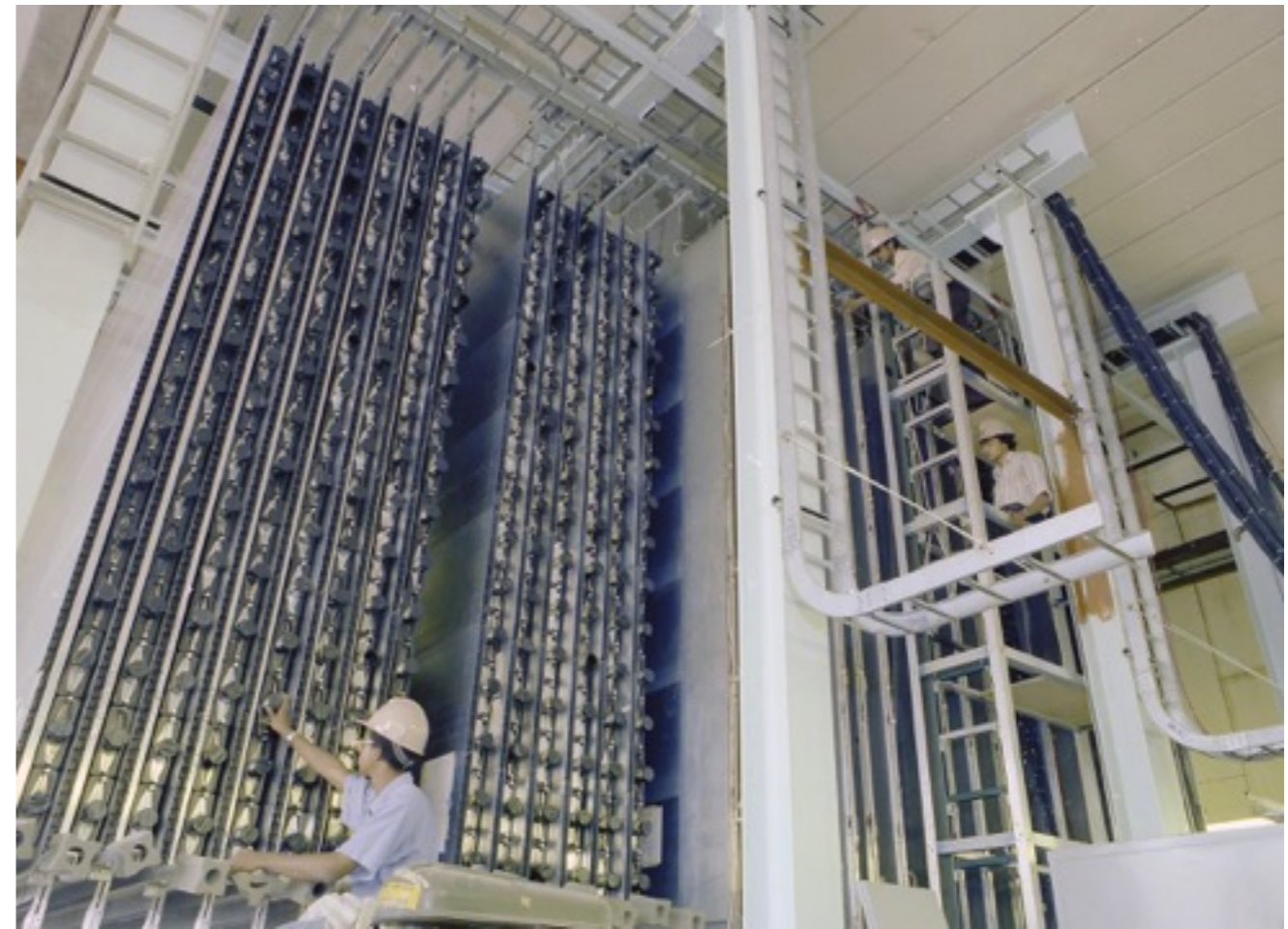

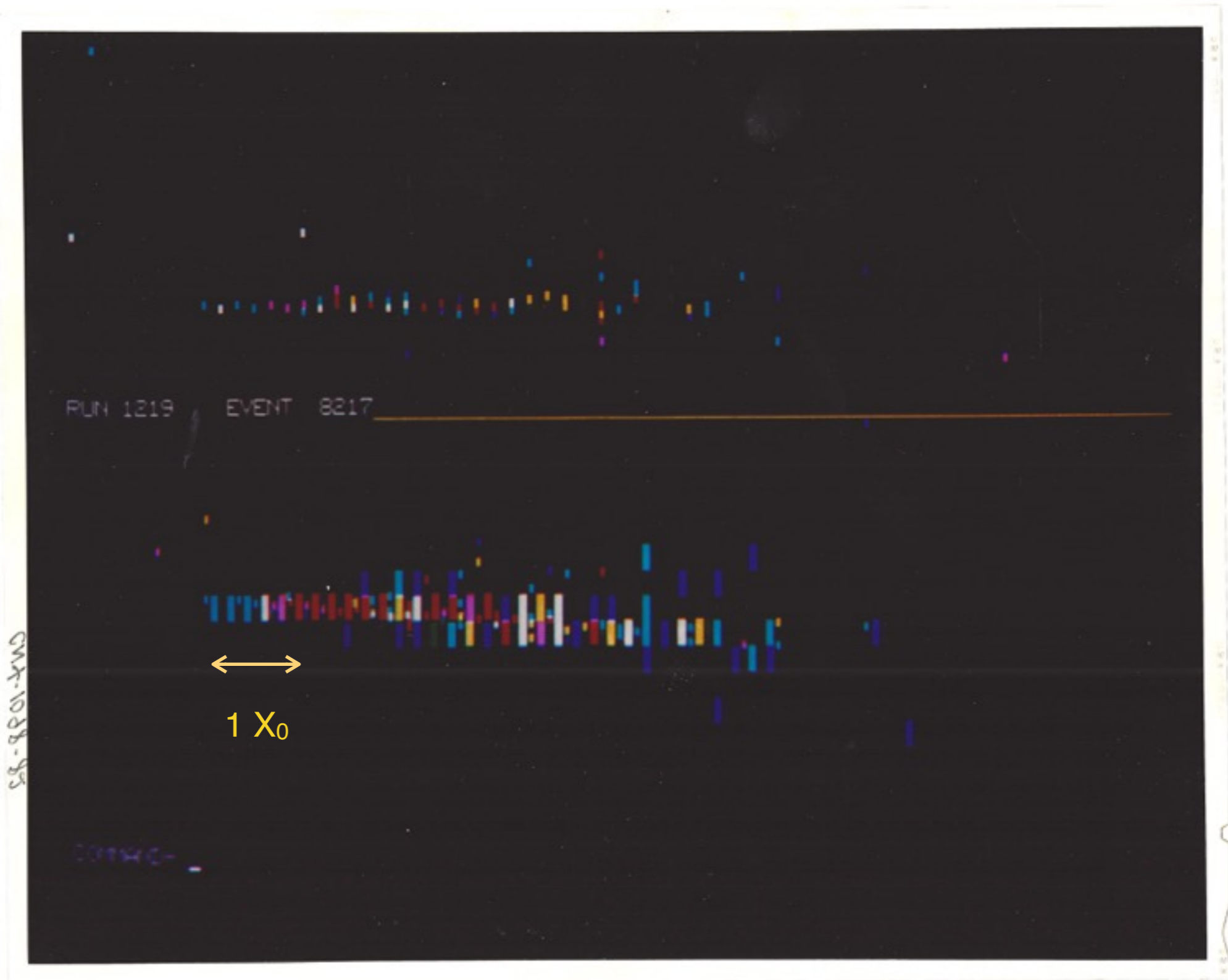

Electromagnetic shower from Experiment E734 in 1986. Example of neutrino electron elastic scattering. This is in liquid scintillator. Energy ~ 2 GeV.

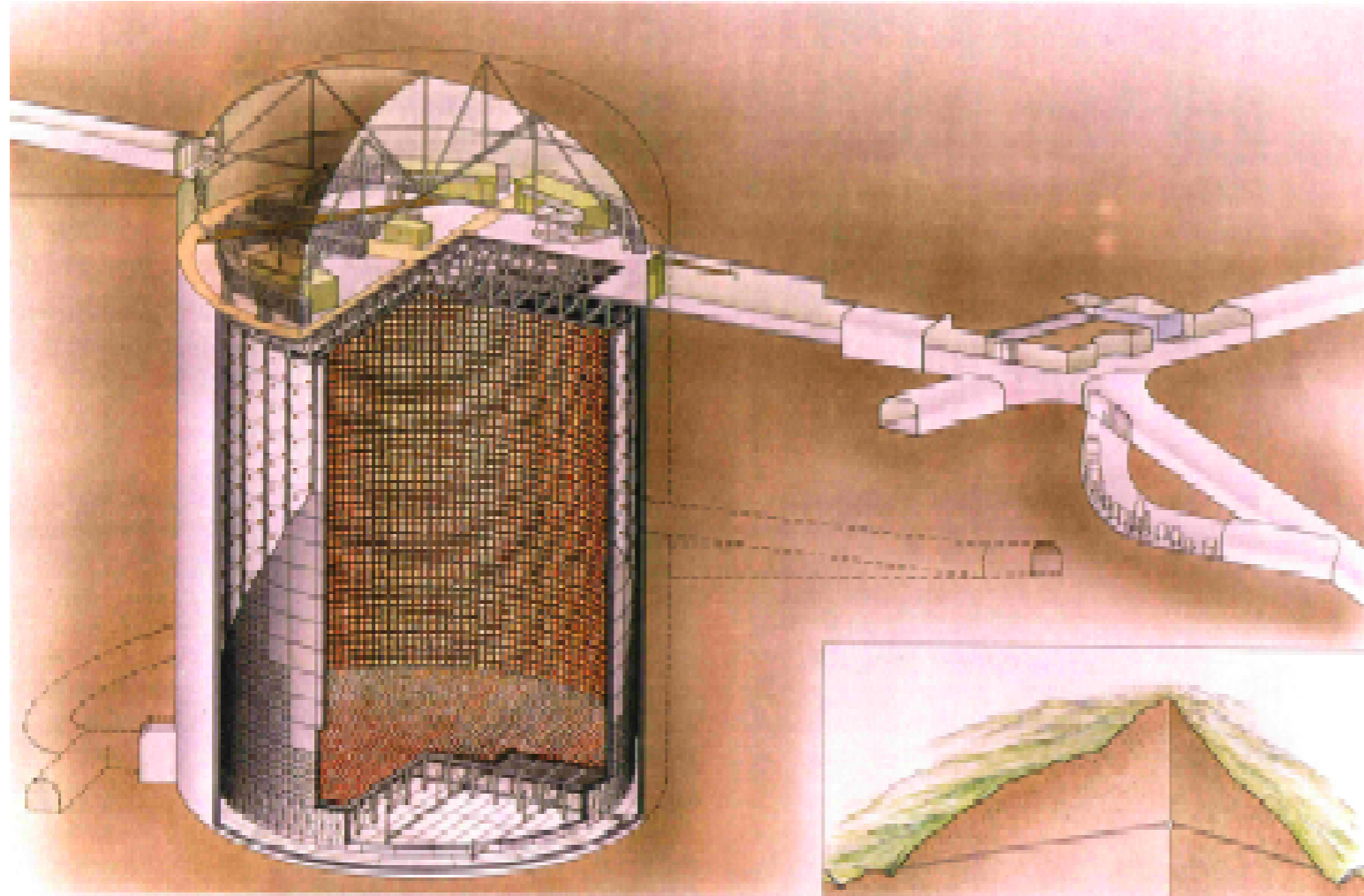

Water Cherenkov SuperKamiokande

Dimensions	42m(H)X39m(W)
Material	Pure Water
Attenuation	~80 m (400nm)
Total mass	40000 ton
Fiducial mass	22000 ton
inner PMTs	11146
Outer PMTs	1885
PMT dim. Inner(outer)	50 cm (20cm)
Inner coverage	~40%
Wavelength	350 nm - 600 nm

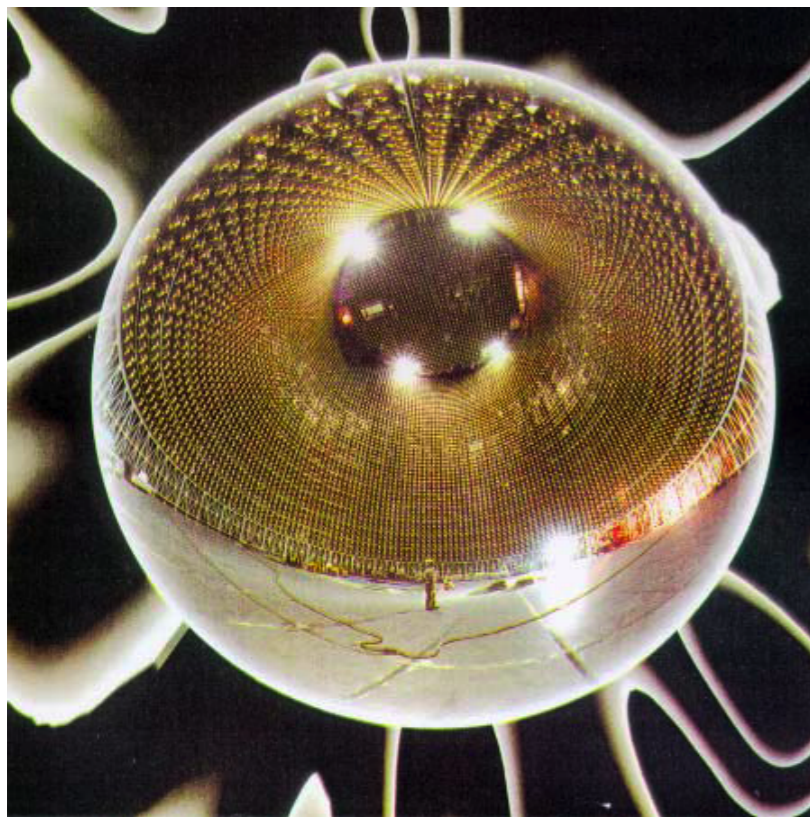

It took 4-5 years to dig and build the detector.
 Ave. Depth ~ 1 km rock
 Cosmic rate ~ 2 Hz

$$Yield = 370 \cdot \sin^2 \theta_c \cdot 0.4 \cdot 0.2 \approx 10 \text{ pe/cm}$$



Coverage X Photon detector efficiency

Technical issue: PMTs have to withstand huge pressure.

Particle Identification

The SuperK discovered that neutrinos from the atmosphere change their flavor in flight

Muon

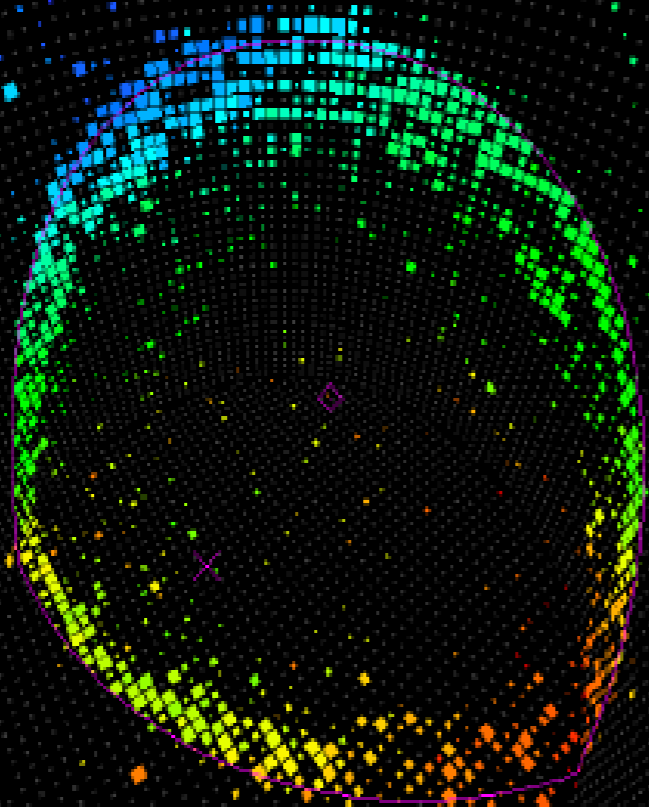

Electron

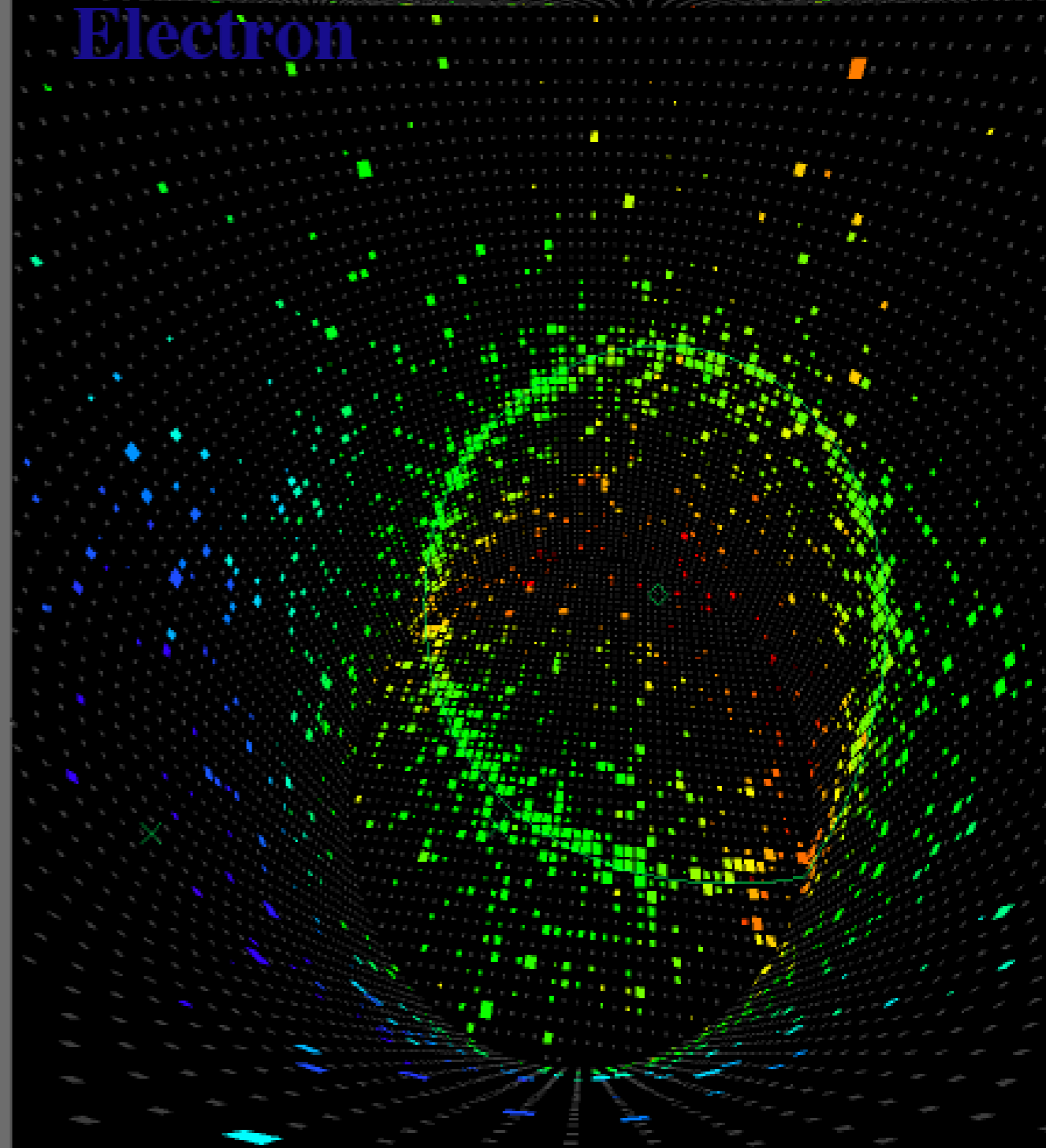

MINOS

- Prepare a pure beam of muon neutrino beam.
- Aim it towards a large muon detector.
- Observe spectrum of muon neutrinos to see oscillations in energy.

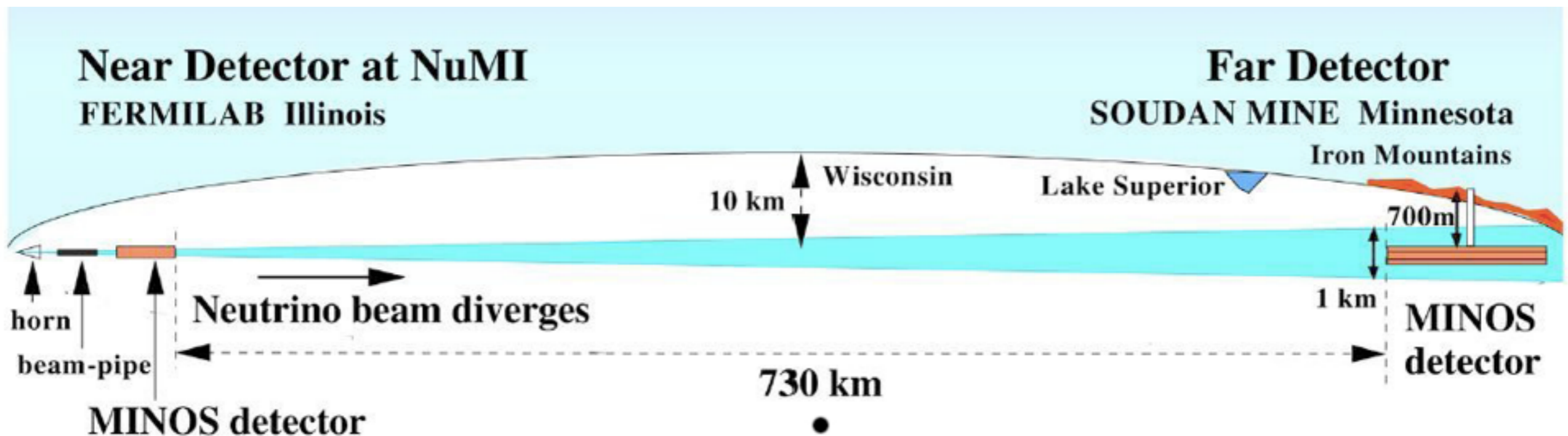

MINOS Detectors



Near Detector

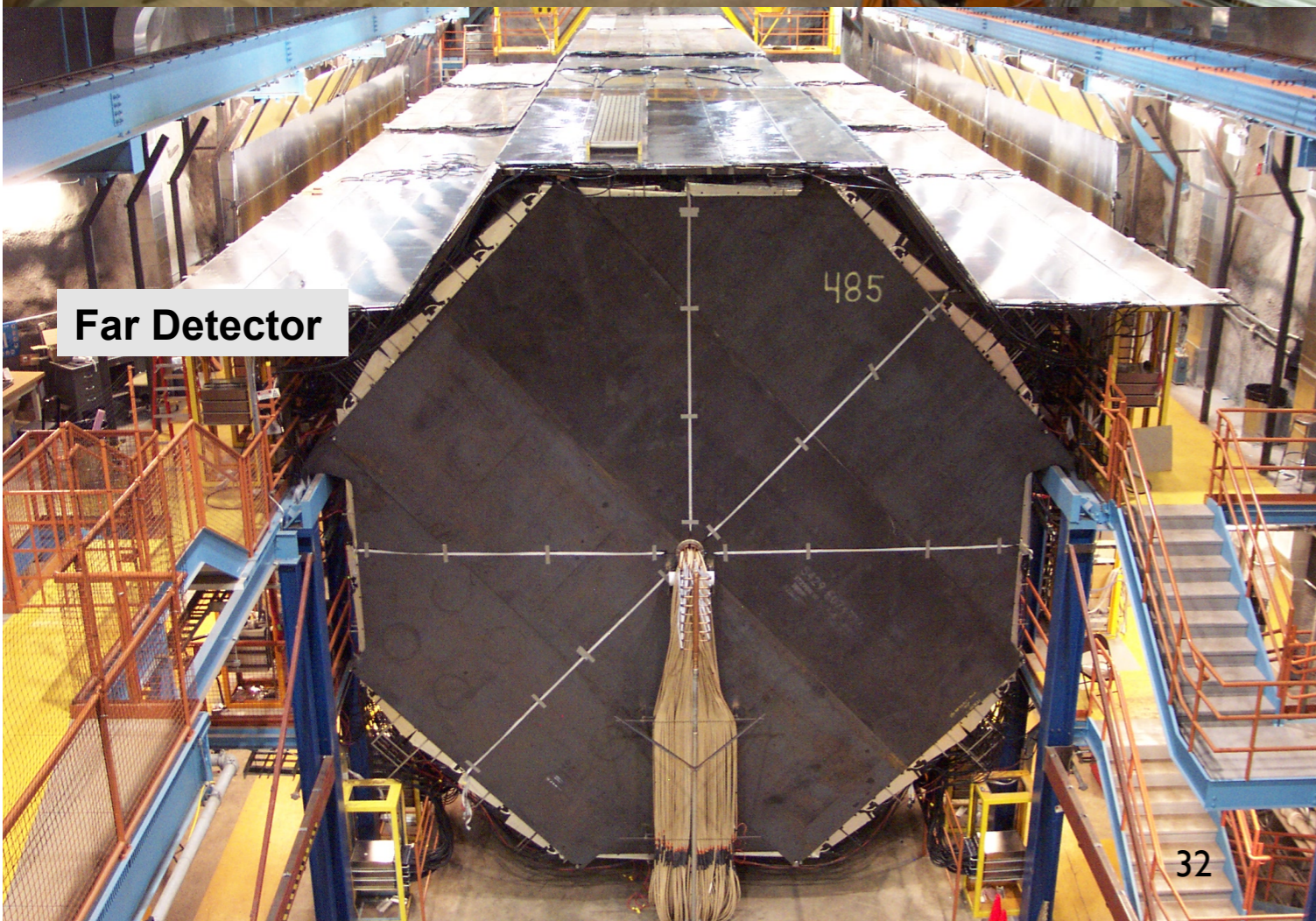

Far Detector

- Massive
 - 1 kt Near detector (small fiducial)
 - 5.4 kt Far detector
- Similar as possible
 - steel planes
 - 2.5 cm thick
 - 1 Muon ~ 27 planes
 - 1.4 radiation lengths
 - scintillator strips
 - 1 cm thick
 - 4.1 cm wide
 - Molier radius ~3.7 cm
- Wavelength shifting fibre optic readout
- Multi-anode PMTs
- Magnetised (~1.3 T)

Far Detector Neutrinos

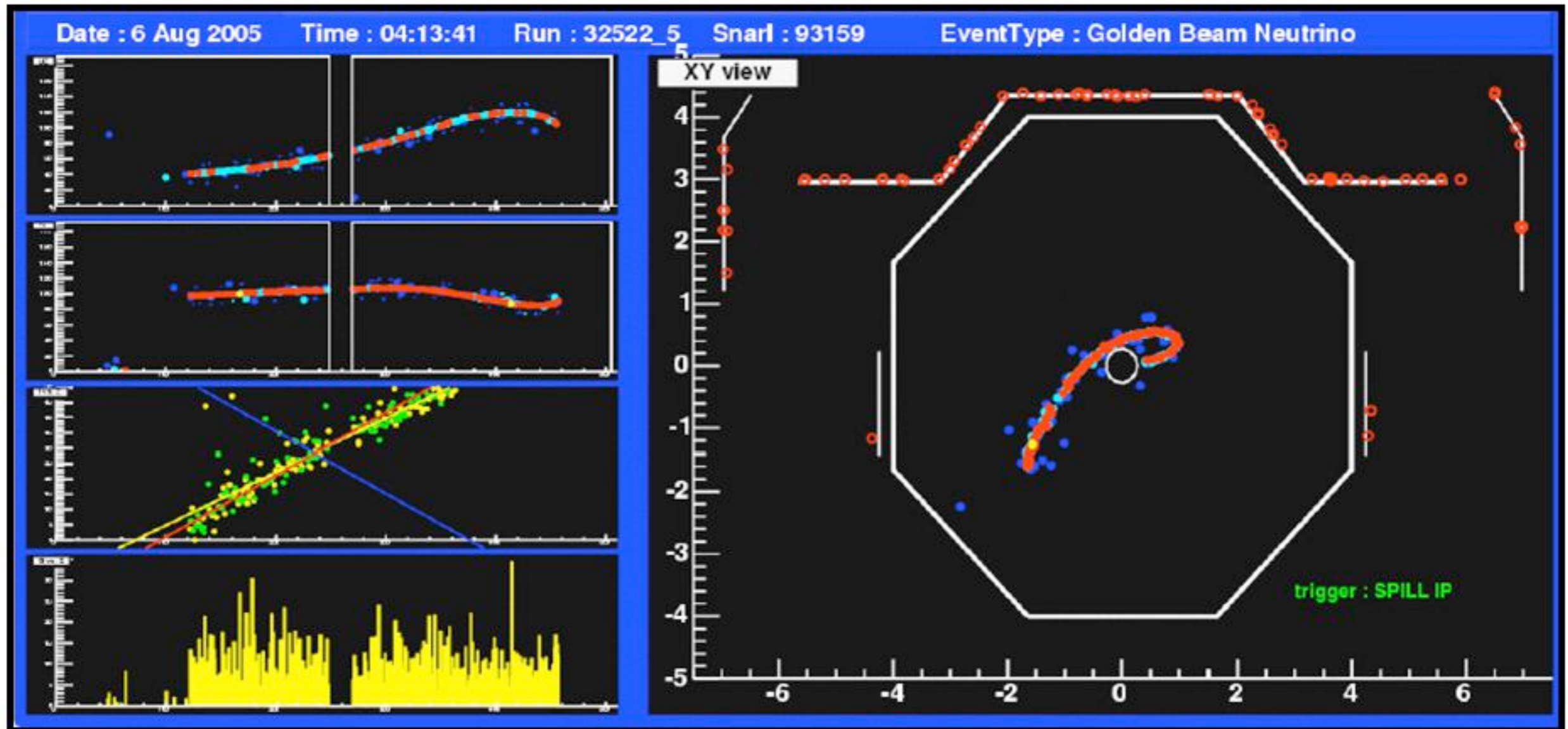

Online event display: <http://farweb.minos-soudan.org/events/>

MINOS saw that muon type neutrinos disappear on their way to the far site.
This allowed precise measurement of neutrino mass squared difference.

The Daya Bay Experiment

Eh3

1540m from Ling Ao I
1910m from Daya Bay
860 m.w.e overburden

Eh2

470m from Ling Ao I
265 m.w.e overburden

Eh1

363m from Daya Bay
250 m.w.e overburden

3 Underground Experimental Halls

Entrance

Tunnels

Ling Ao II Cores

Ling Ao I Cores

Daya Bay Cores

- 17.4 GW_{th} power
- 8 operating detectors
- 160 t total target mass

Shenzhen 45 km
Hongkong 50 km

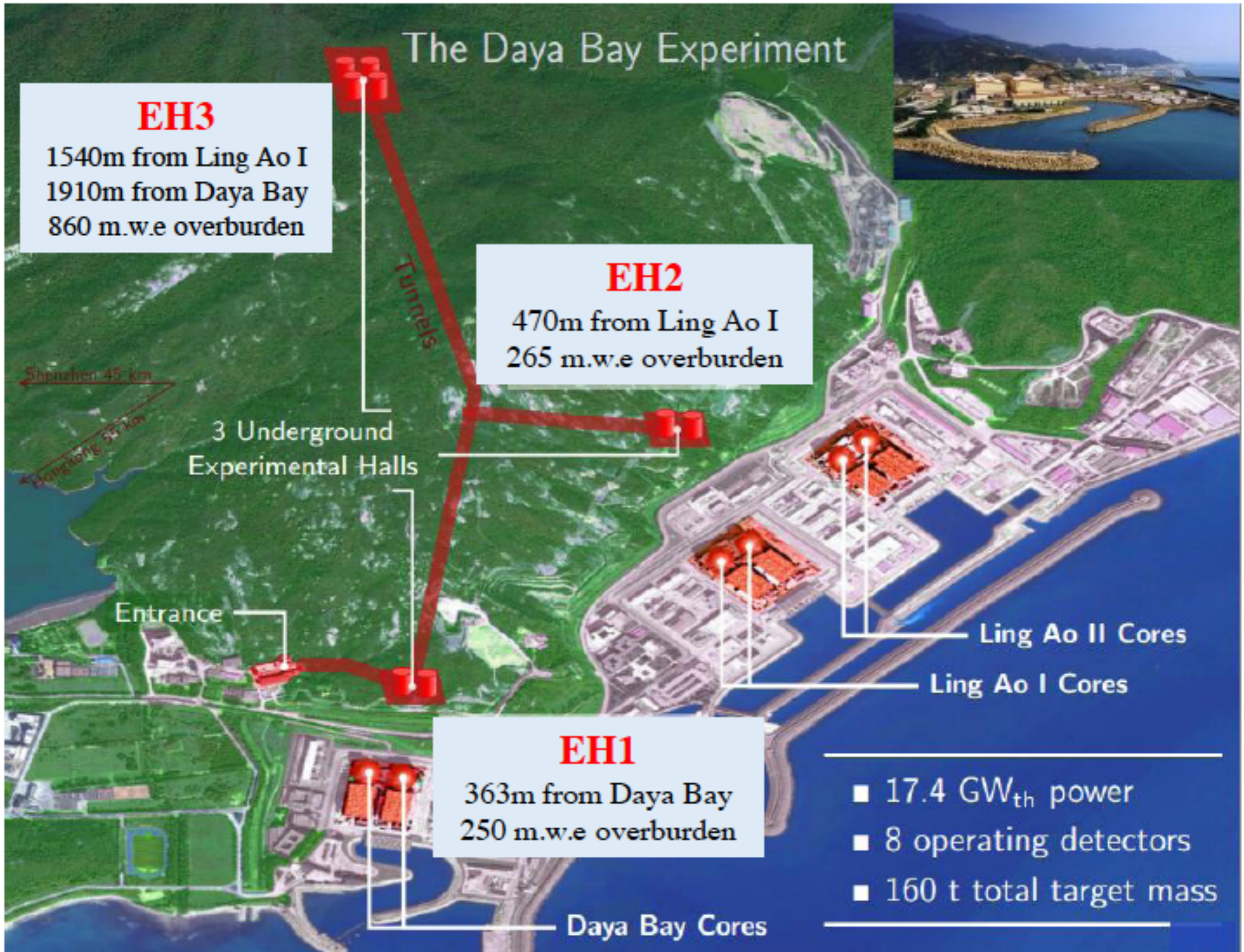

Daya Bay Antineutrino Detectors (AD)

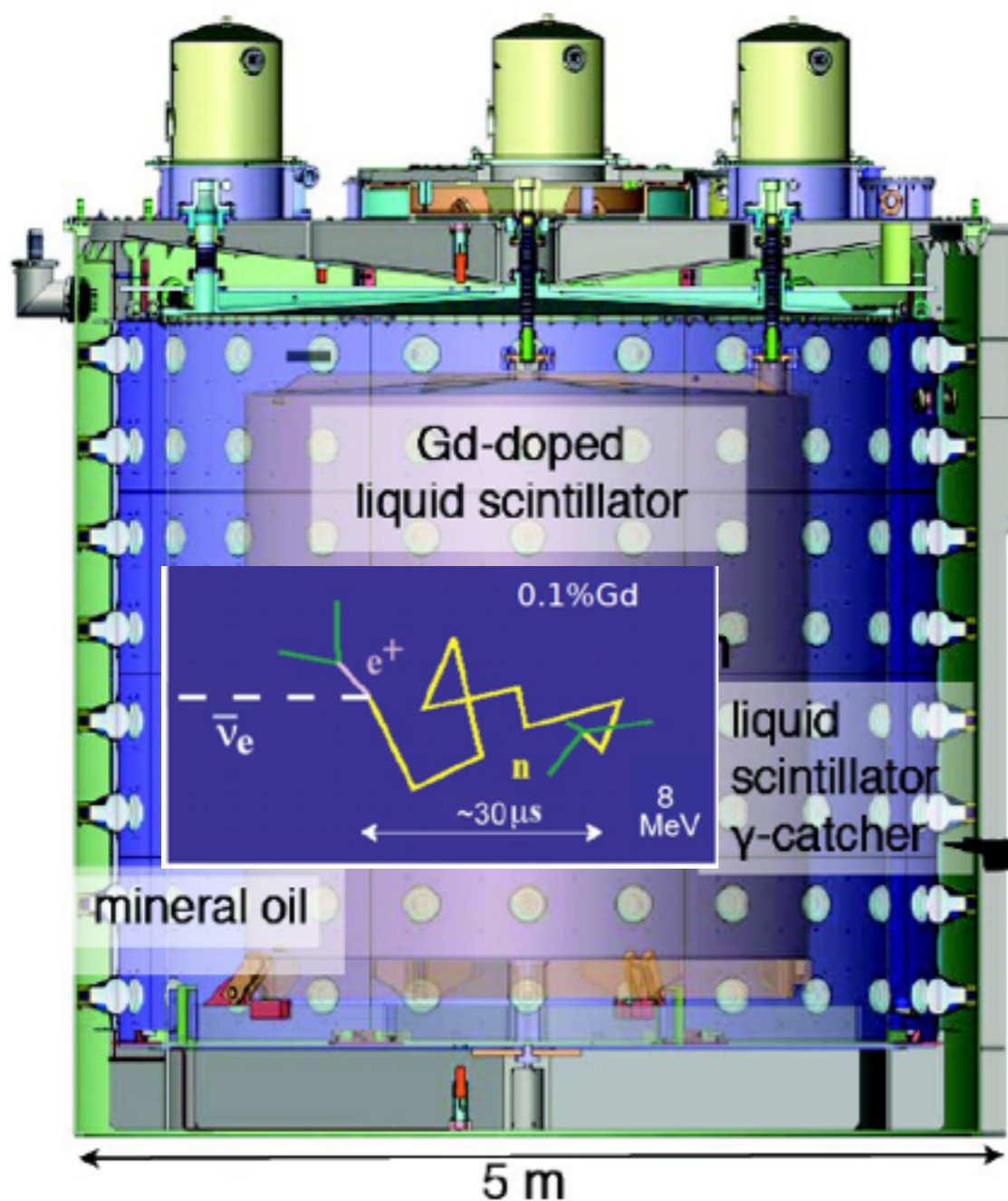

automated calibration system

reflectors at top/ bottom of cylinder

photomultipliers

steel tank

radial shield

outer acrylic tank

inner acrylic tank

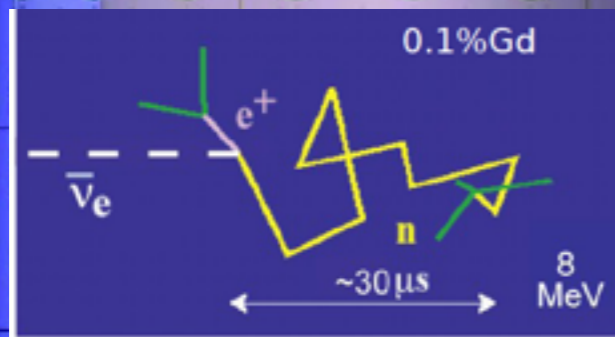

liquid scintillator γ -catcher

mineral oil

5 m

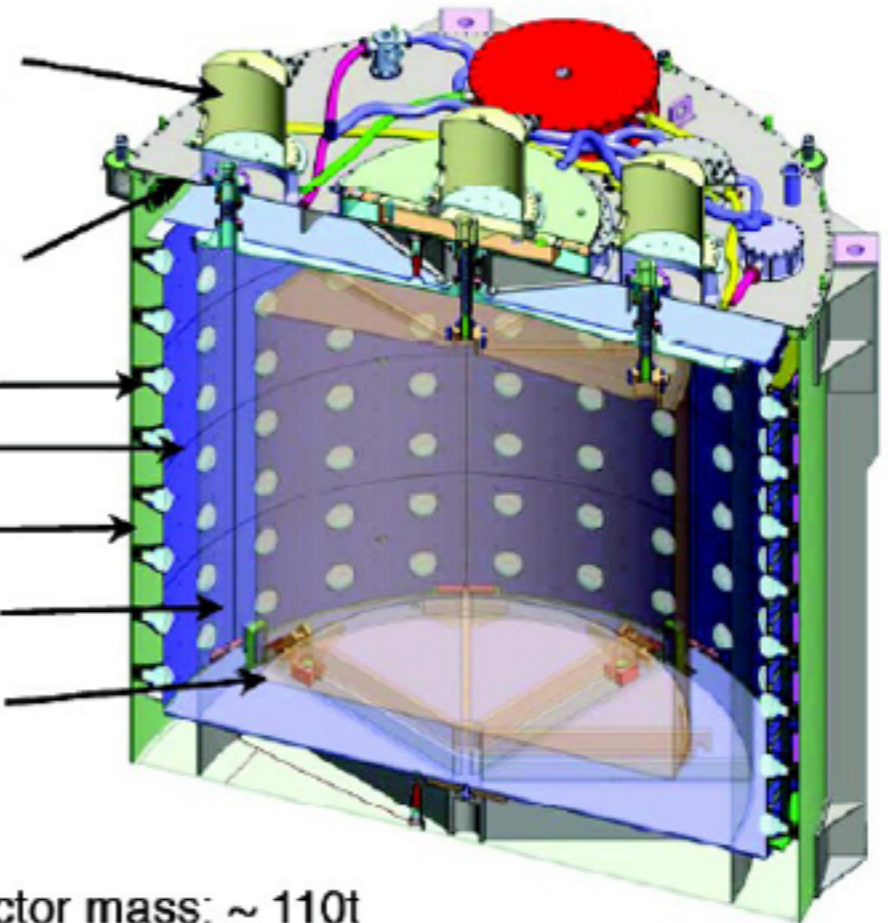

total detector mass: $\sim 110t$

inner: 20 tons Gd-doped LS (d=3m)

mid: 22 tons LS (d=4m)

outer: 40 tons mineral oil buffer (d=5m)

photosensors: 192 8"-PMTs

$$Yield = 10^4 \text{ MeV}^{-1} \times Coverage \times QE$$

$$= 10^4 \times 0.08 \times 0.2 \sim 160 \text{ pe / MeV}$$

8 "functionally identical", 3-zone detectors reduce systematic uncertainties.

Very well defined target region

magnetized steel detector (INO)

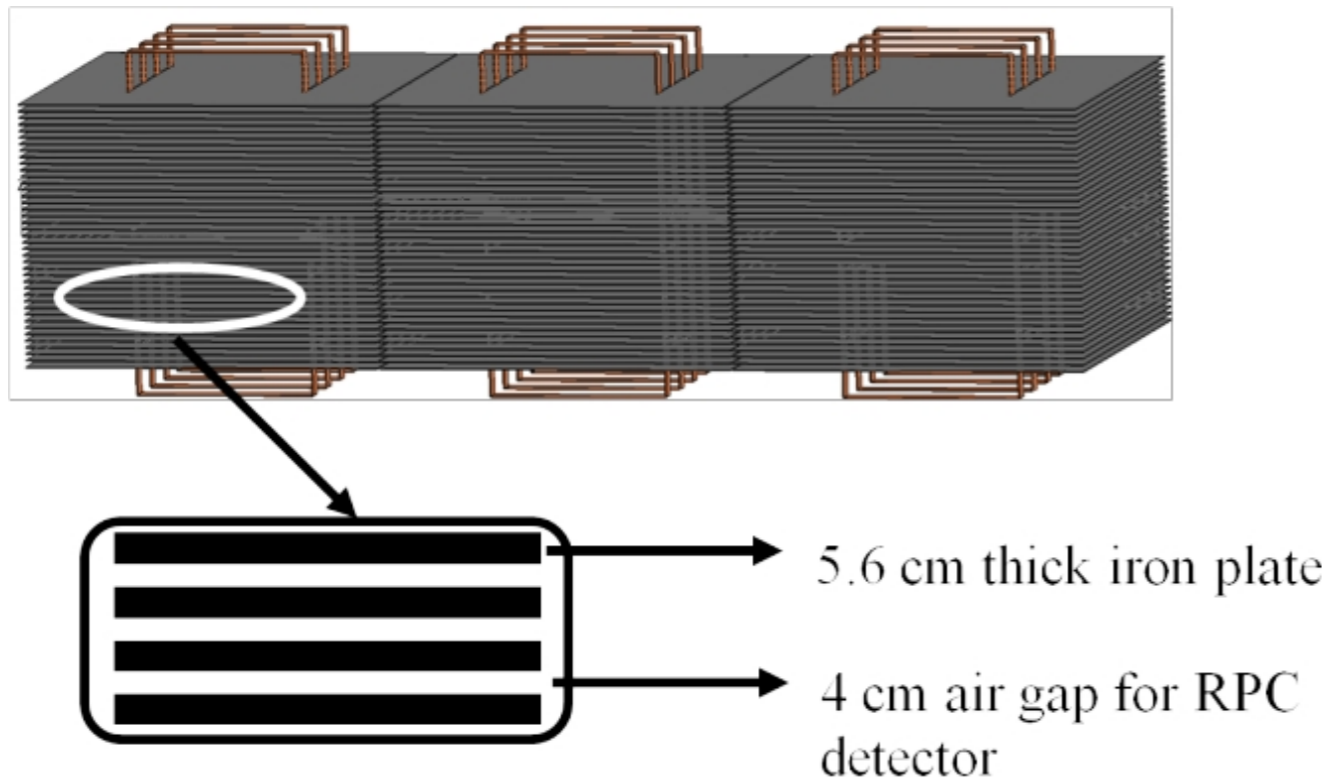
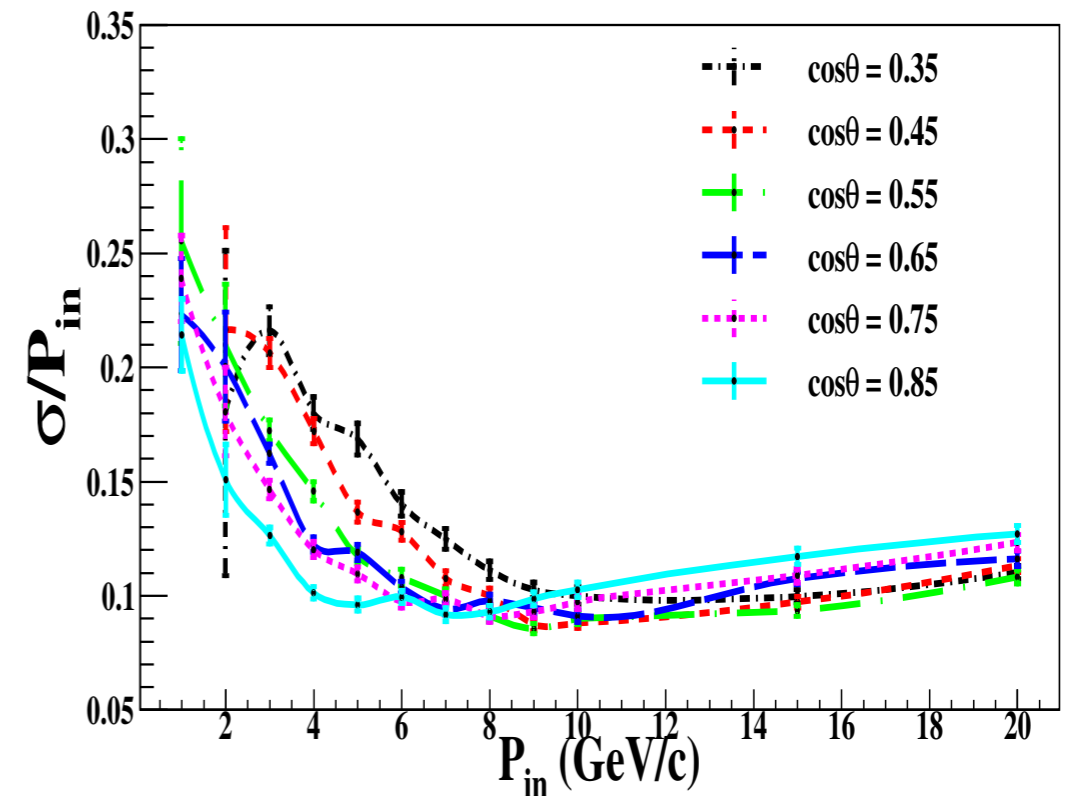

Figure 1.3: Schematic view of the 50 kt ICAL detector



Modules	3
Module area	16 x 16 m
Layers	151
Fe thickness	5.6 cm
Gap	4 cm
Field	1.5 T
Mass	17 ktons

RPC dims	2 m x 2 m
strip width	3 cm
RPC/layers	64
RPC/module	~10000
Total channels	3.9 M (x/y)

Magnetic spectrometer analysis

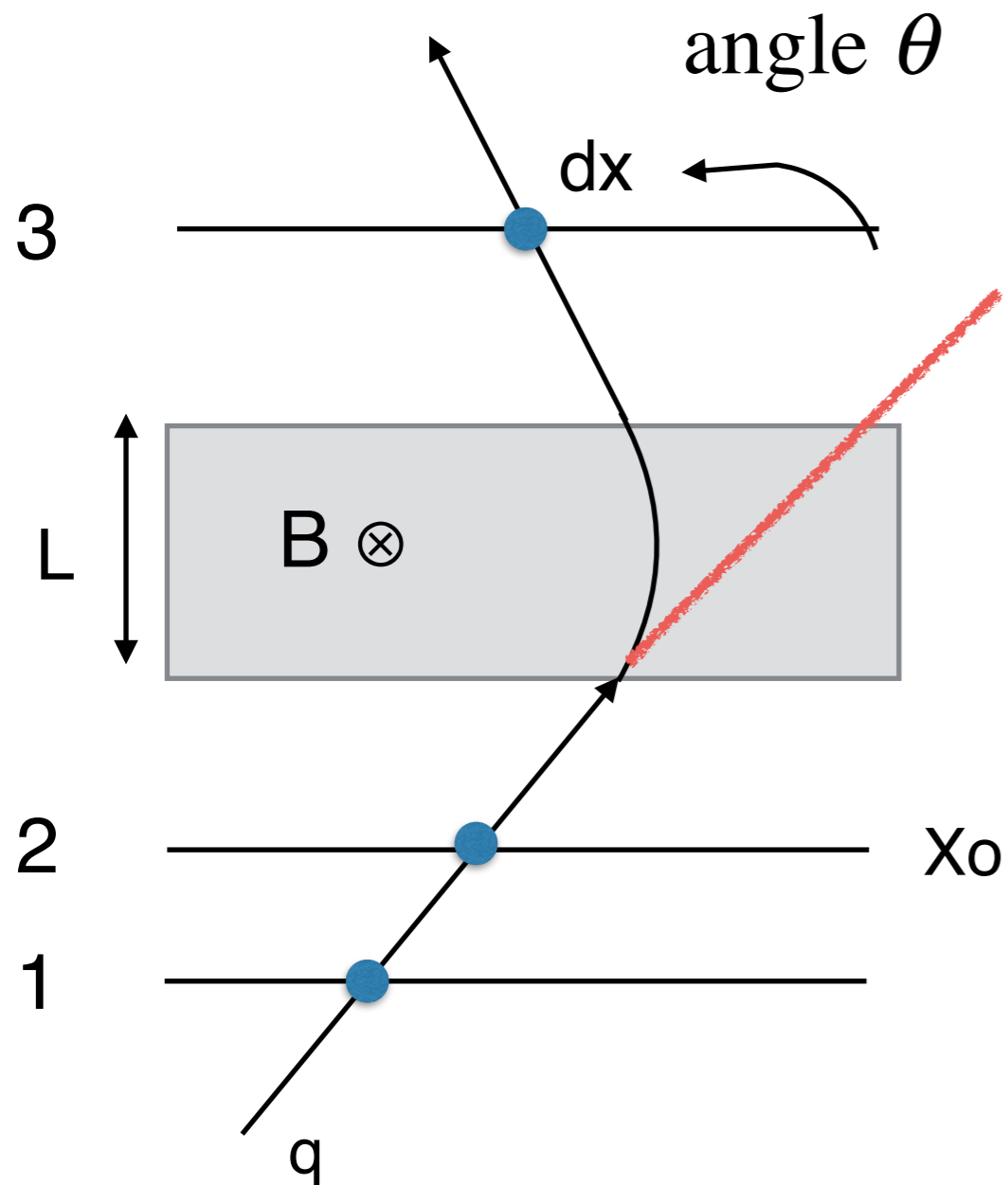

A complete analysis requires a fit to the points (x_i, z_i) , but we will perform a back of envelope analysis of a simple setup

$$p \cos(\lambda) = 0.3z B R \quad (\text{To measure momentum we need } R)$$

p is particle momentum in GeV/c, λ is the pitch angle.

B is in Tesla and R is in meters. z is the particle charge in e.

There are 3 planes with measurement error (δx)

$$k = 1/R = \text{curvature} = \frac{\theta}{S} \approx \frac{\theta}{L} \quad (S \text{ is the pathlength.})$$

$$dk^2 = dk_{res}^2 + dk_{ms}^2 \quad (\text{resolution and multiple scattering})$$

$$dk_{res}^2 \approx \frac{1}{L^2} \left(2 \frac{\delta x_1^2}{D^2} + 2 \frac{\delta x_2^2}{D^2} + \frac{\delta x_3^2}{D^2} \right) \quad (\text{assume } D \text{ intra-plane dis.})$$

$$dk_{ms}^2 \approx \frac{0.016}{L p \beta \cos^2 \lambda} \sqrt{X_0} \quad (p \text{ in GeV/c, } X_0 \text{ is rad. len. fraction})$$

The Future of neutrino experiments in the US

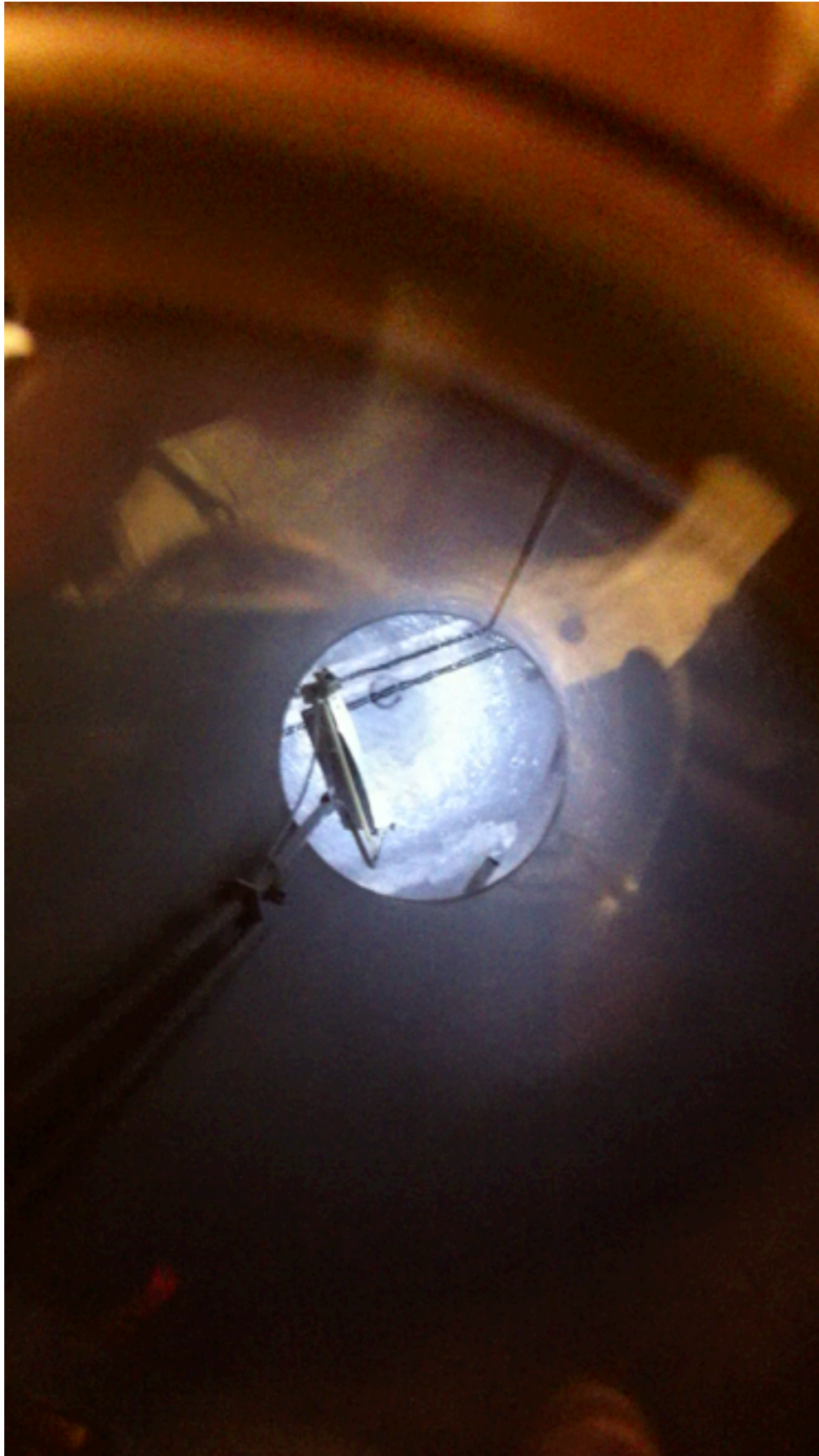

What does LAR look
it? It is a clear liquid.

It is heavier than water:
1.44 gm/cc

Must be kept at -303 F
in an insulated
container

Newest detection technology at CERN

09/24/2018 20:23:23
NPOVERVIEW1

control room

electronics

cryogenics

detector cryostat

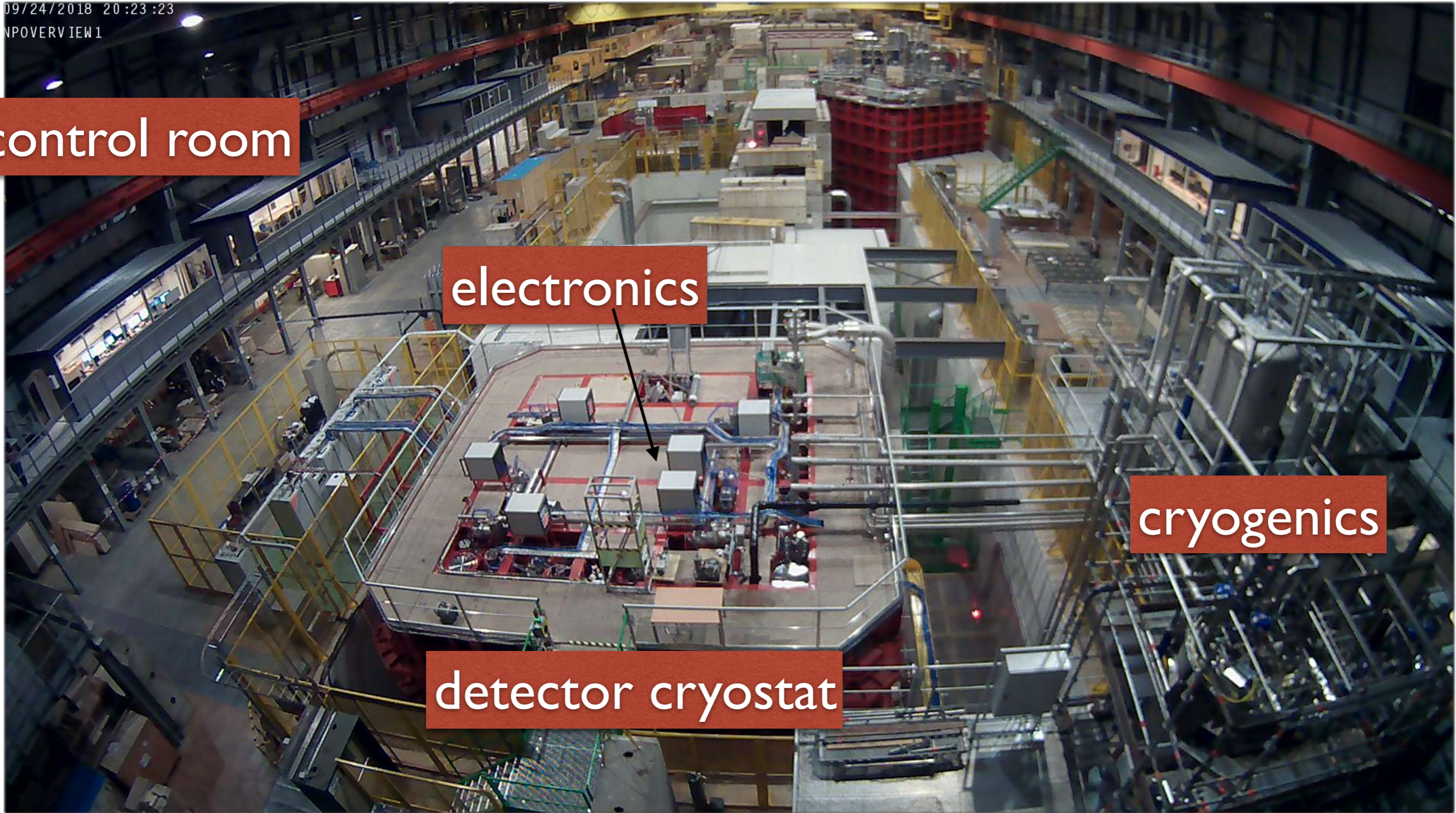



View of feedthrough inside

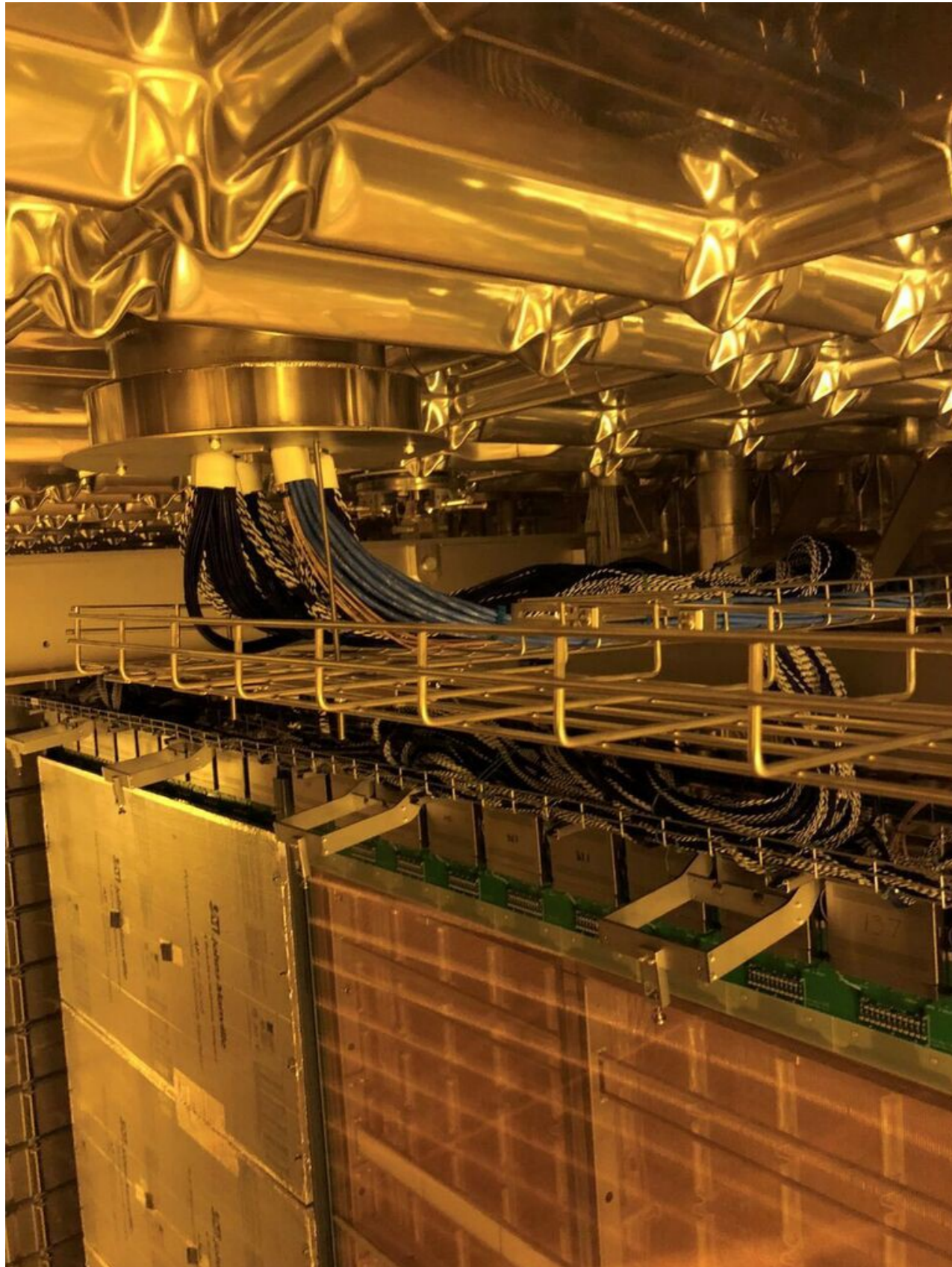

View of feedthrough outside

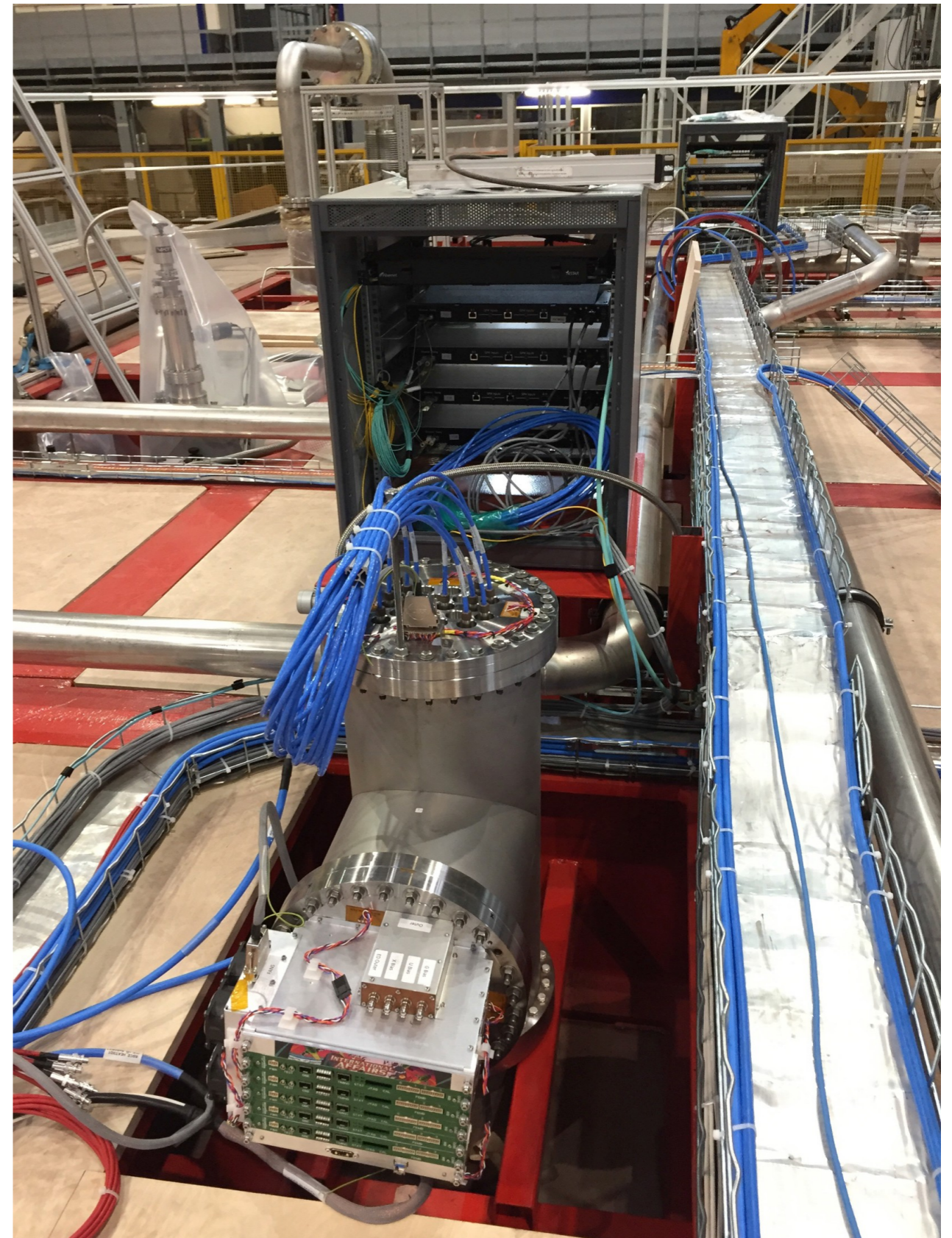

3d

Size
1 8

Opacity
0 1

Plain Color

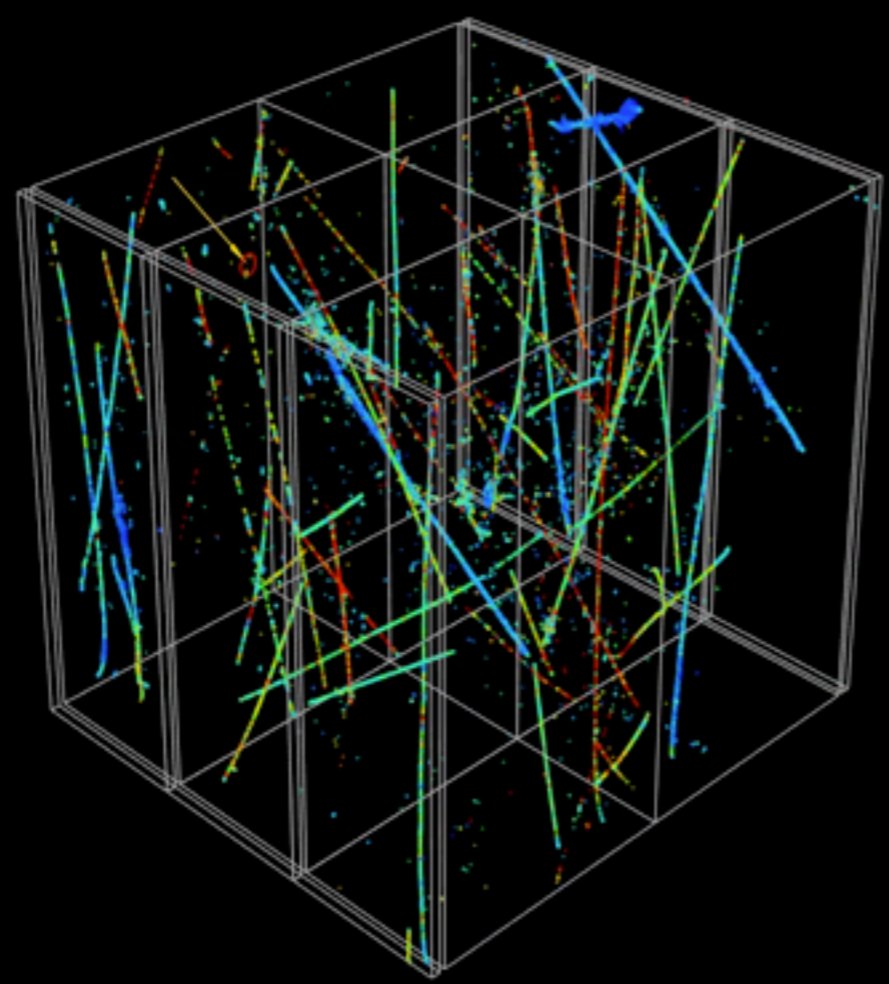

General

Event 0

Theme dark

Show Charge

Color-scale 0.21

Show Cluster

Overlay Reco

Helper

Live

Refresh

Interval 60

Flash

Recon

1.36

Box

Slice

Camera

Center to Event

Ortho Camera

Multi-view

2D View

Photo Booth

Reset

Close Controls



ASIDE ON DARK MATTER DETECTION (from Galbiati)

- *Development of noble liquid technology has created opportunity for dark matter detection.*
- *ArDM/DARKSIDE collaboration has invented a way to nearly eliminate radioactivity from Liquid Argon (Ar39)*
- *Extremely low background is possible with mass of as much as 300 tons.*
- *Current project is ~50 ton.*

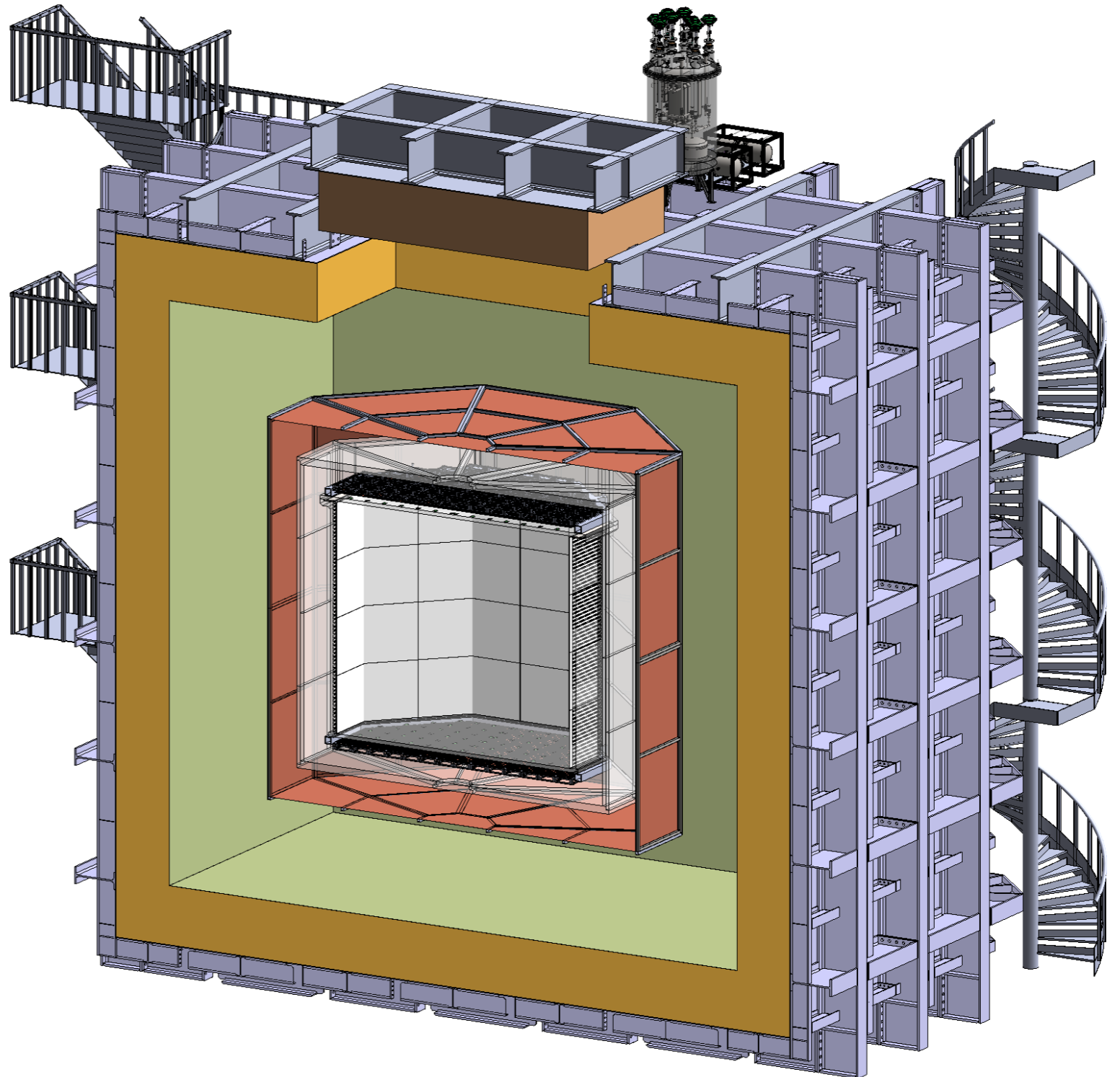

Conclusion

- This lecture was about the basics of neutrino detectors.
 - But many techniques are common for all detectors.
- Most important feature for neutrino detectors is inexpensive mass.
- Detectors are designed to measure light emission or charge deposition from neutrino interactions.
- The current motivation for neutrino detection is to study the properties of neutrinos themselves. Most important properties are mass and mixing.
- For each application additional considerations must be made
 - Energy threshold and resolution
 - Time and location measurement of events
 - Particle identification through a variety of mea

