

X-ray / Gamma-ray detectors

Varun Bhalerao
(IIT Bombay)

What information do photons carry?

Where

When

What type

Polarization

Position

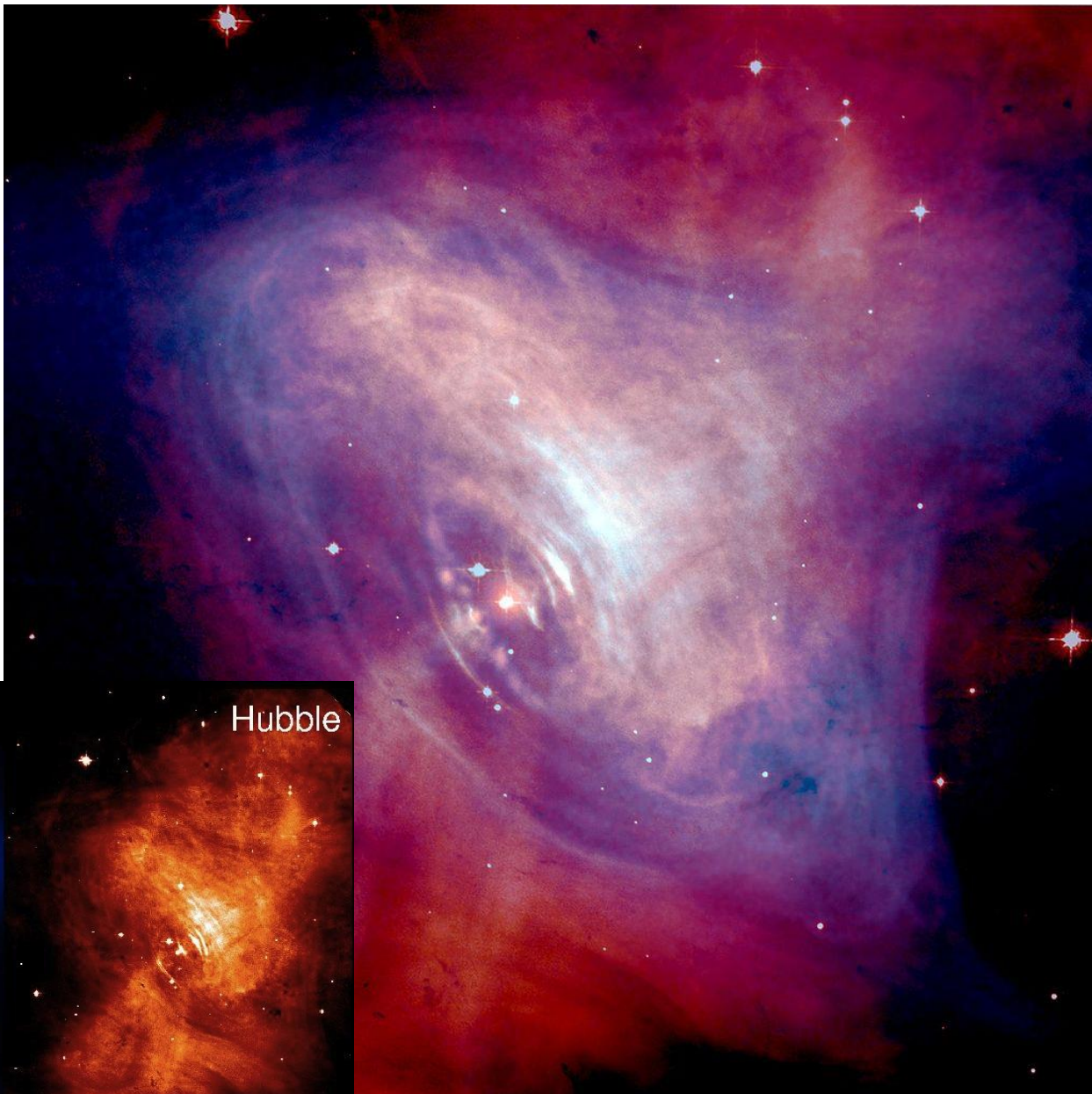
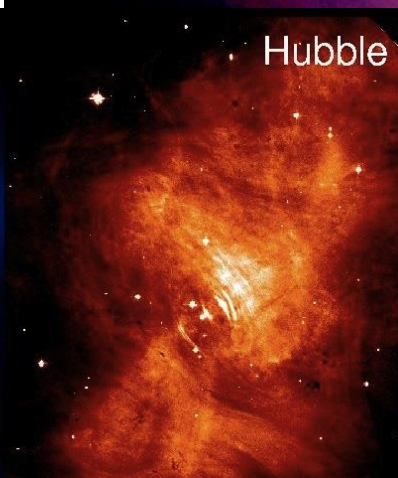
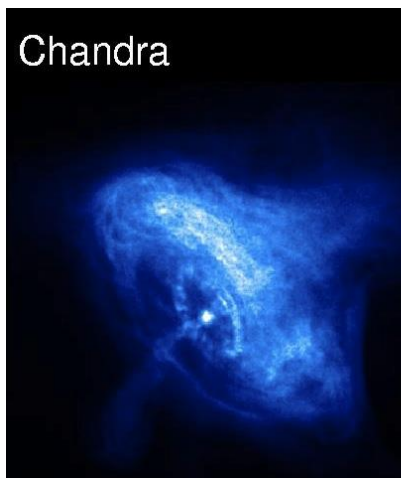

Time

- Time at which photon arrived
 - » Relate to emission time as all photons are from the same object

- Periodicity
 - » Eg: Pulsars

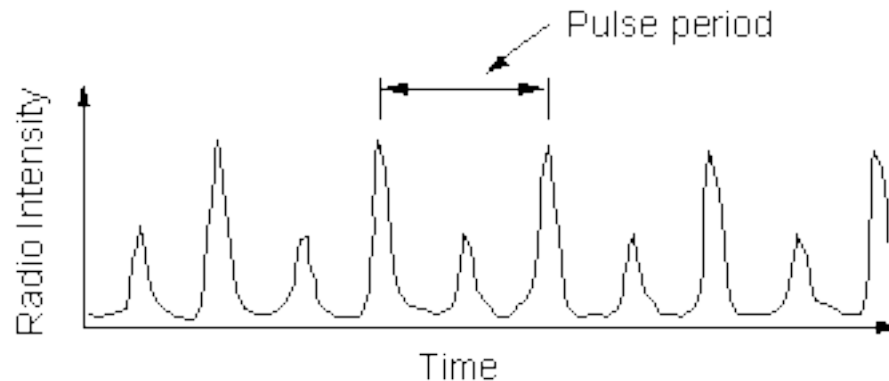

- Object size (light crossing time)

Energy

Wavelength
Frequency

X-rays
UV



IR
Radio

Science needs → Technical specs

- High absorption of X-rays
 - » Attenuation
 - » High cross section
 - » High density
- Large number of carriers generated
 - » Deposited Energy
 - » Uncertainty
- Quick response
 - » High charge carrier mobility

Types of detectors

- Cadmium Zinc Telluride
- Germanium
- X-ray CCDs
- Strip detectors
- Gas-filled proportional counters
- Scintillators
- ...

Cadmium Zinc Telluride Imager



Solid state detectors: material selection

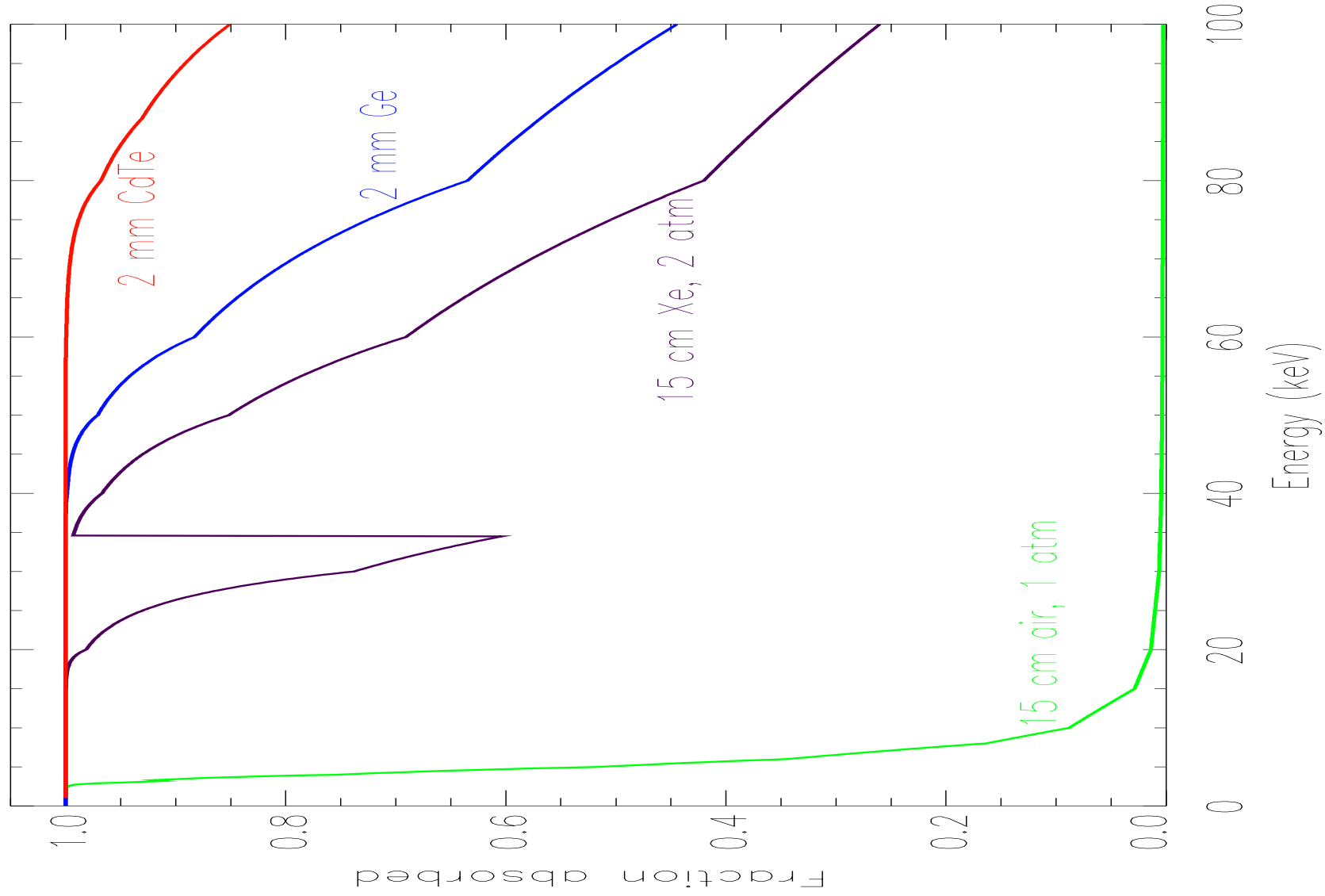

Semiconductors

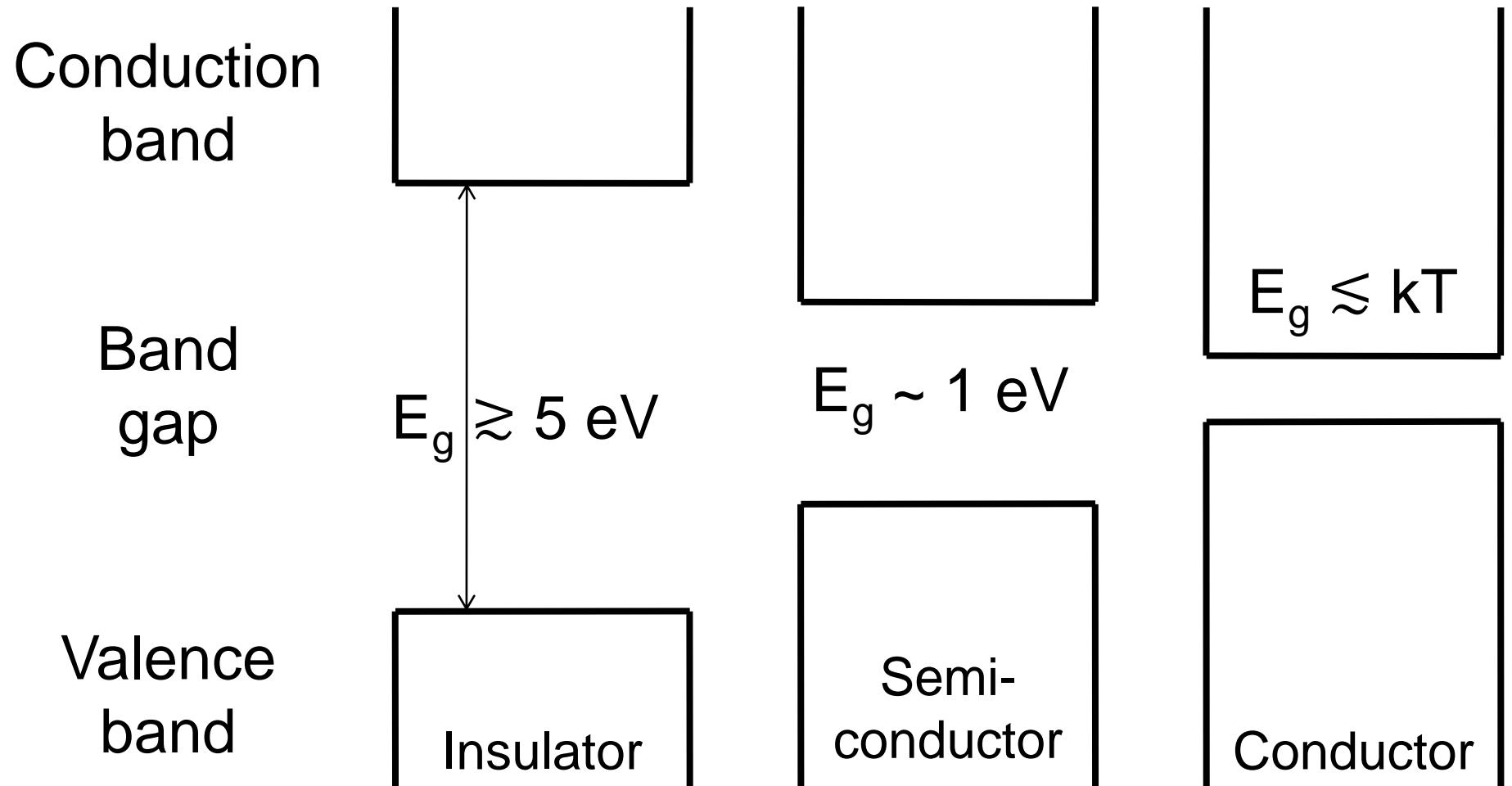

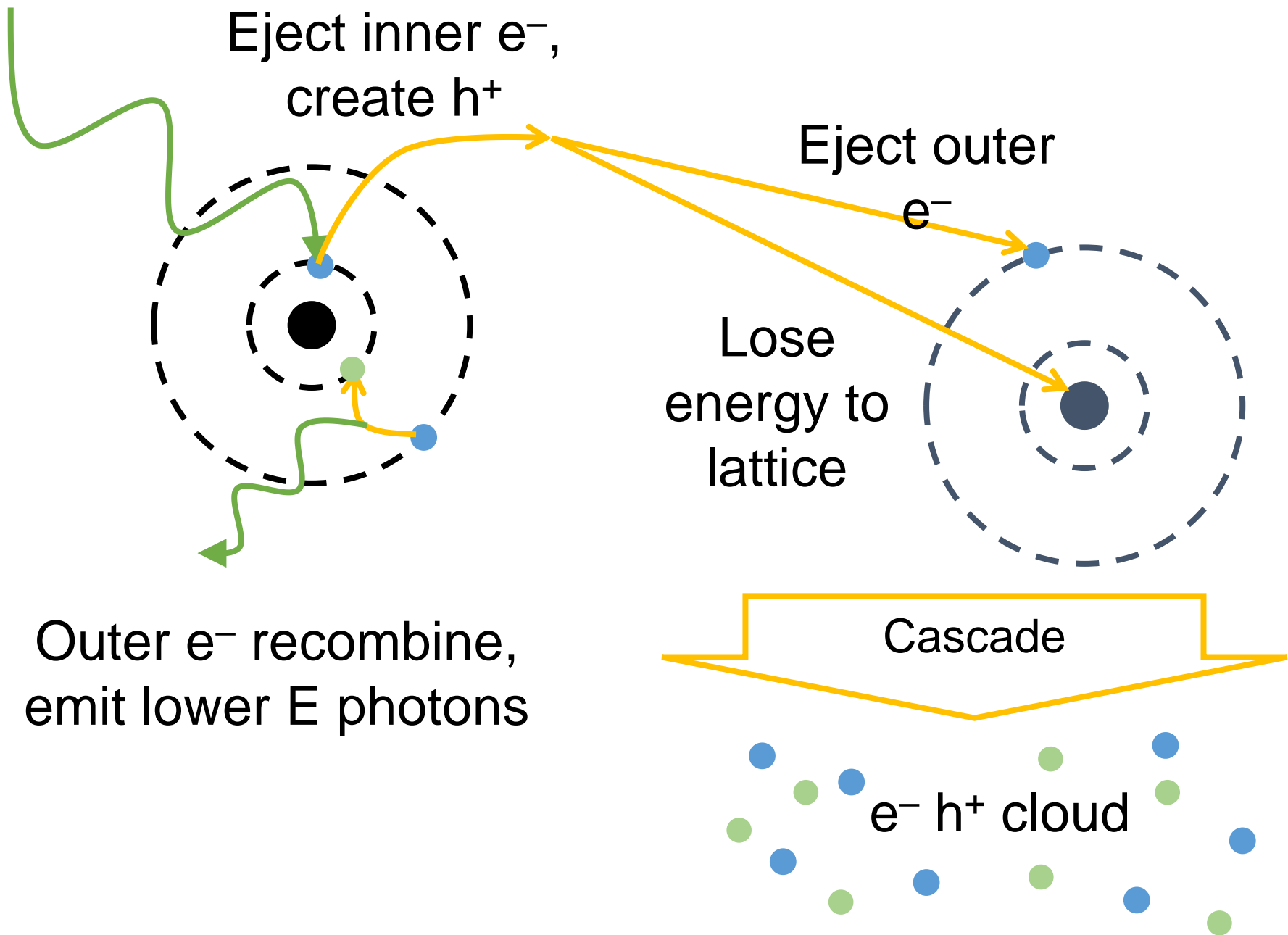

A Basic CZT detector

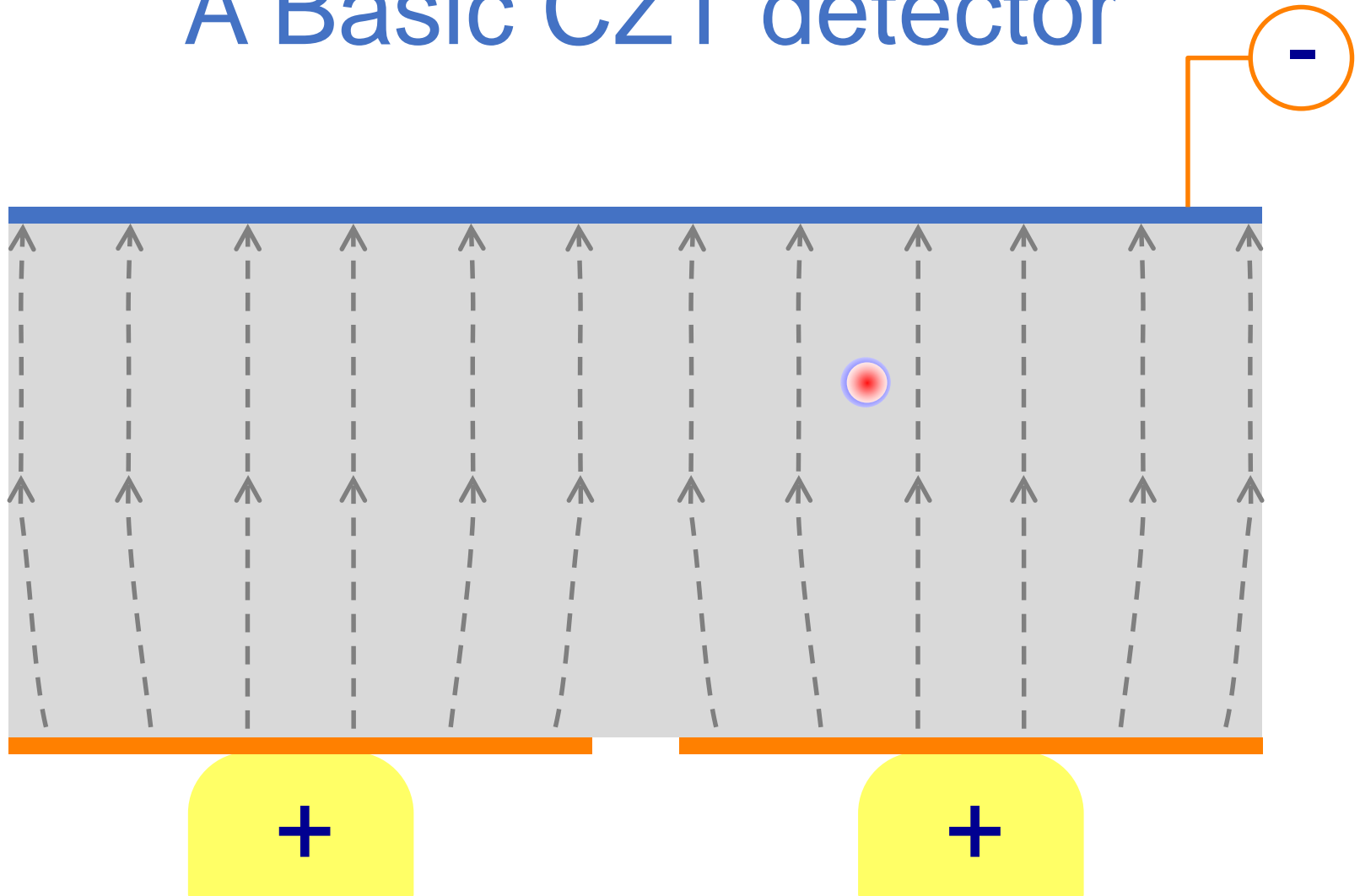

Ge: Typical geometry

- Hollow cylindrical structure most common
- Edges rounded off to eliminate low electric field regions
- “Puck” geometry possible, but limited thickness

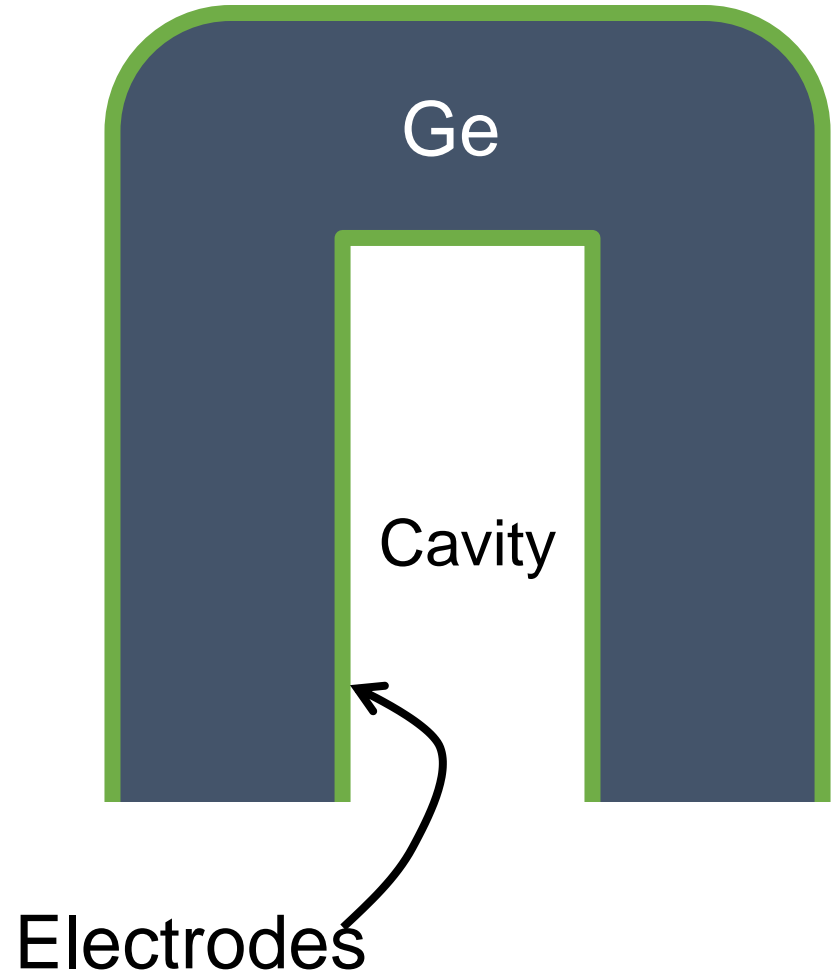

Ge: Energy response

- Effective band gap: 2.96 eV
- Fano factor: 0.08
- Energy resolution: 0.2% at 1 MeV

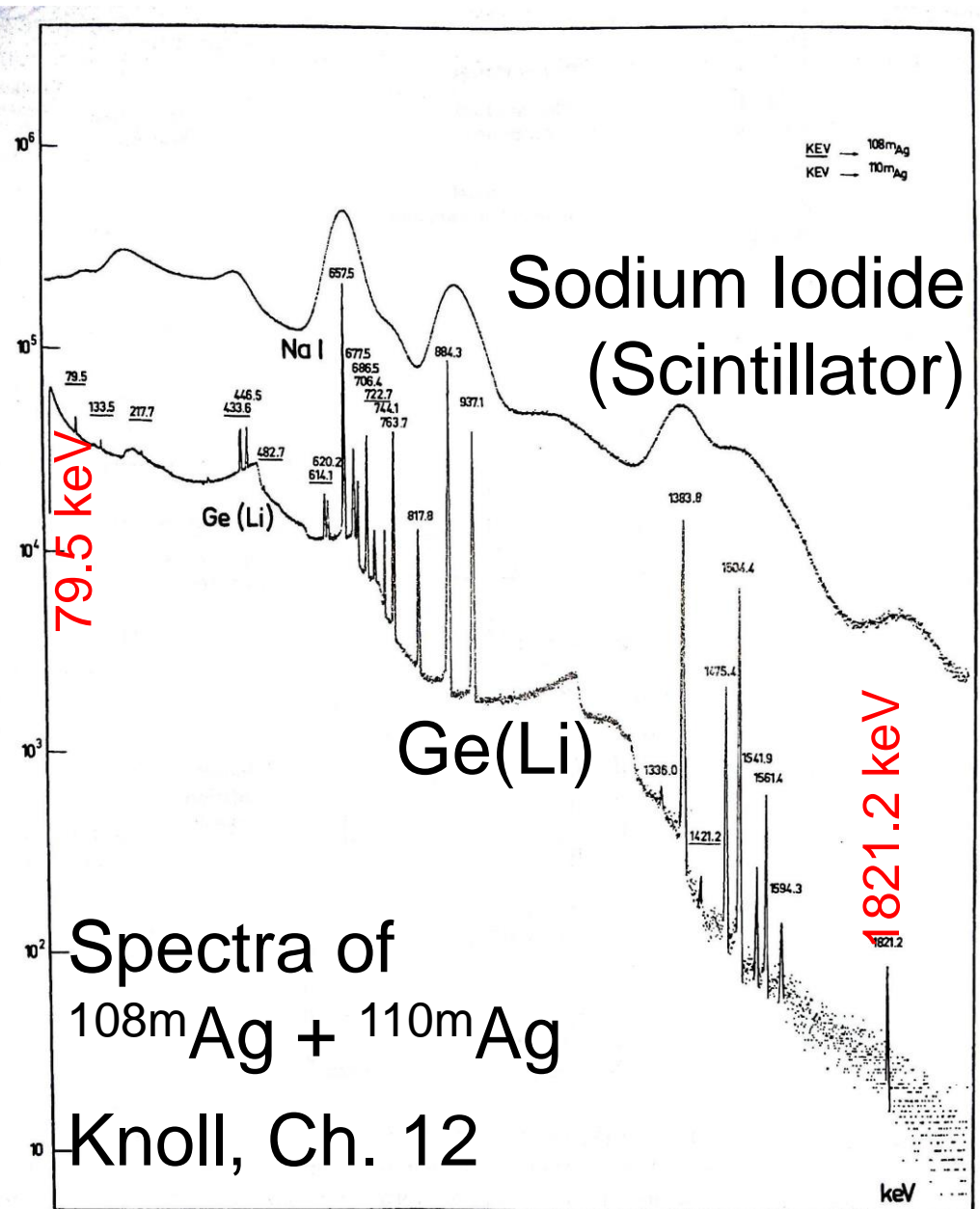

X-ray CCDs: Astrosat SXT

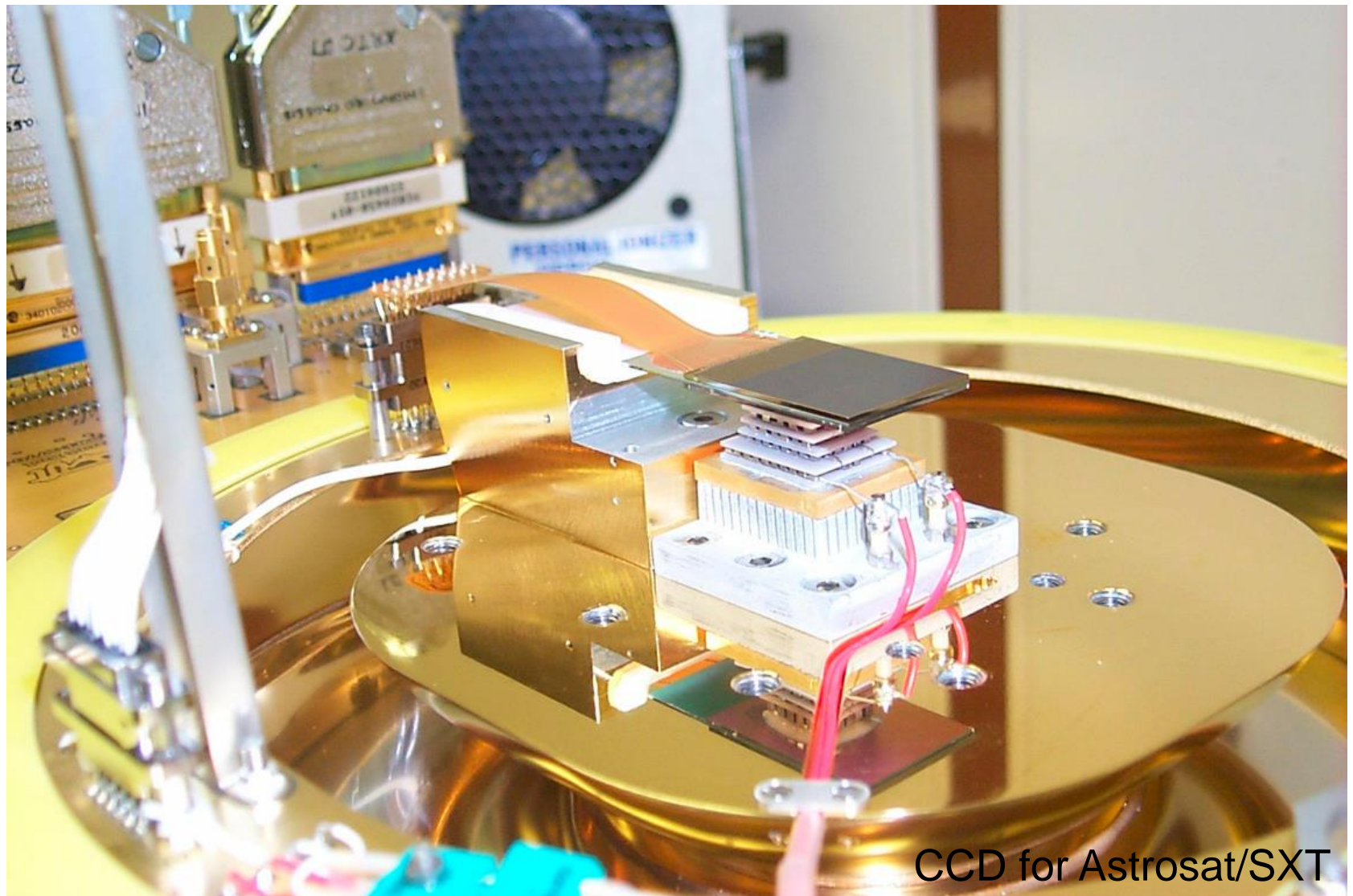

CCD Principle

- Solid state detector
 - » Physics similar to Ge
 - » Photons \rightarrow electrons \rightarrow readout
 - » Effective band gap 3.65 eV
- Pixelled detector
 - » Same as optical CCDs !
- Integrate and read
 - » Poor time resolution

Working of CCD

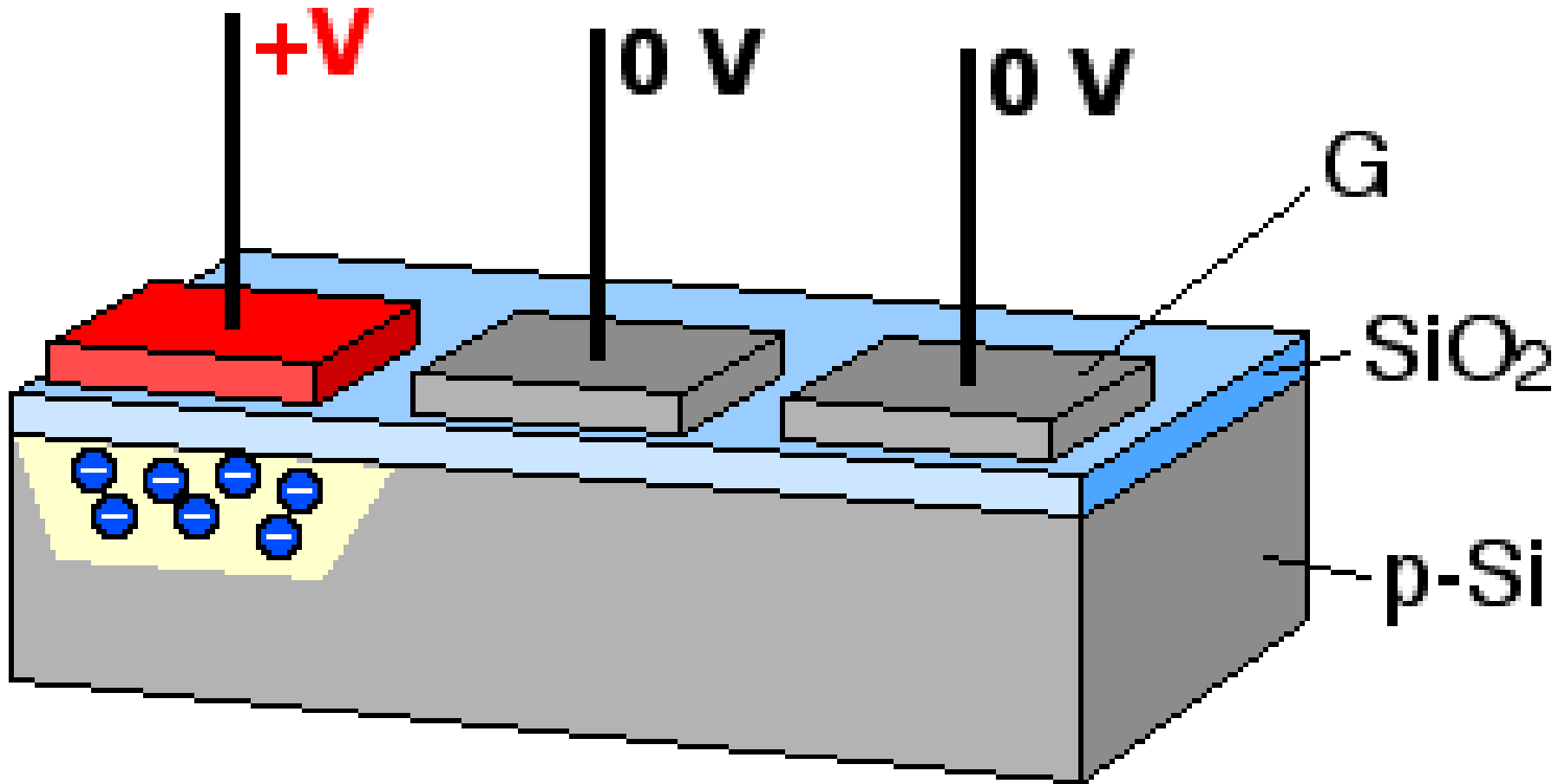

http://en.wikipedia.org/wiki/Charge-coupled_device#mediaviewer/File:CCD_charge_transfer_animation.gif

Readout

Clocking Parallel Register

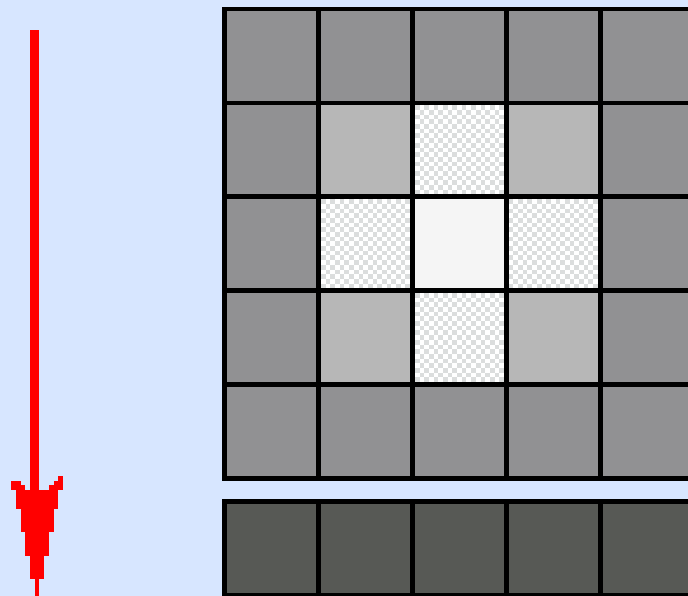

<http://www.astro.virginia.edu/class/oconnell/astr511/lec11-f03.html>

How many photons?

- Optical: 1 photon \rightarrow 1 electron
- X-ray: $1/3.65$ electrons per eV
 - » About 274 electron-hole pairs per keV
- Example: measured 2740 e⁻h⁺ pairs in a pixel
 - » 1 photon, 10 keV?
 - » 5 keV + 5 keV?
 - » 2 keV + 3 keV + 5 keV?

CCD issues

- Transparent at high energies
 - » Front illuminated: ~ 0.1 keV to ~ 10 keV
 - » Back illuminated can work down to tens of eV
- Energy resolution:
 - » Charge transfer inefficiency
 - » Read noise
- 50 eV at 0.1 keV, 190 eV at 10 keV (Swift XRT)

LAXPC: Proportional Counter



Proportional counter

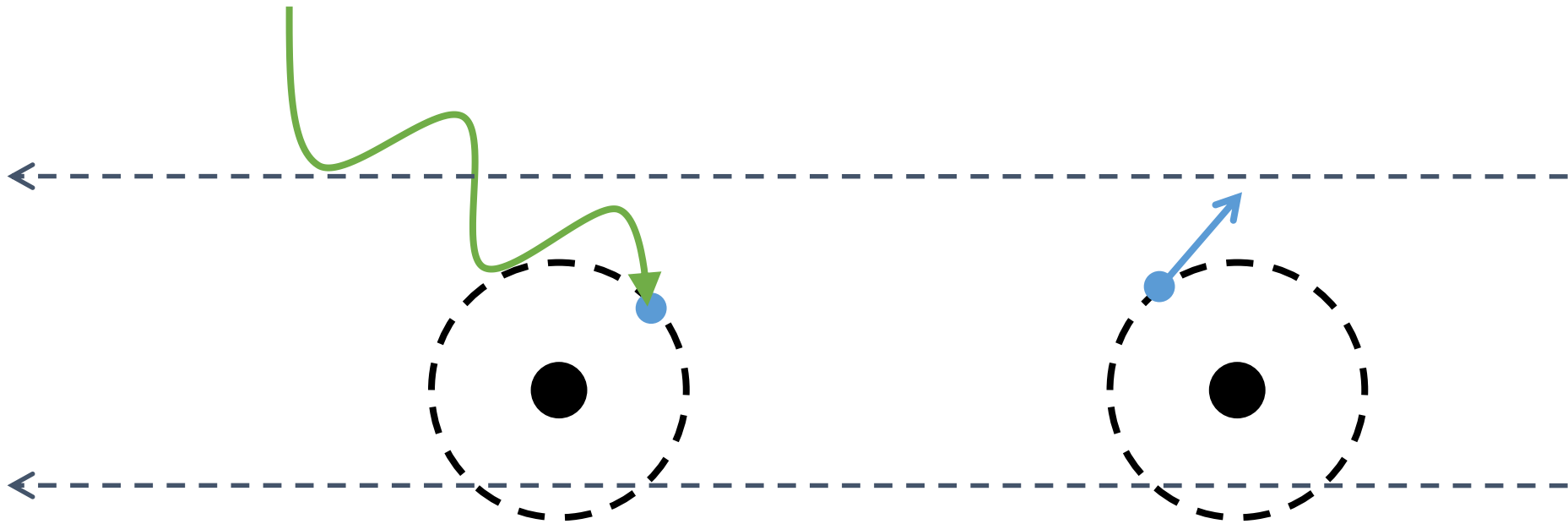

← Electron total energy =
← Initial KE + acceleration in field ← Electric field

Position sensitivity

- Multiple wires in one direction
- Use charge division along other direction

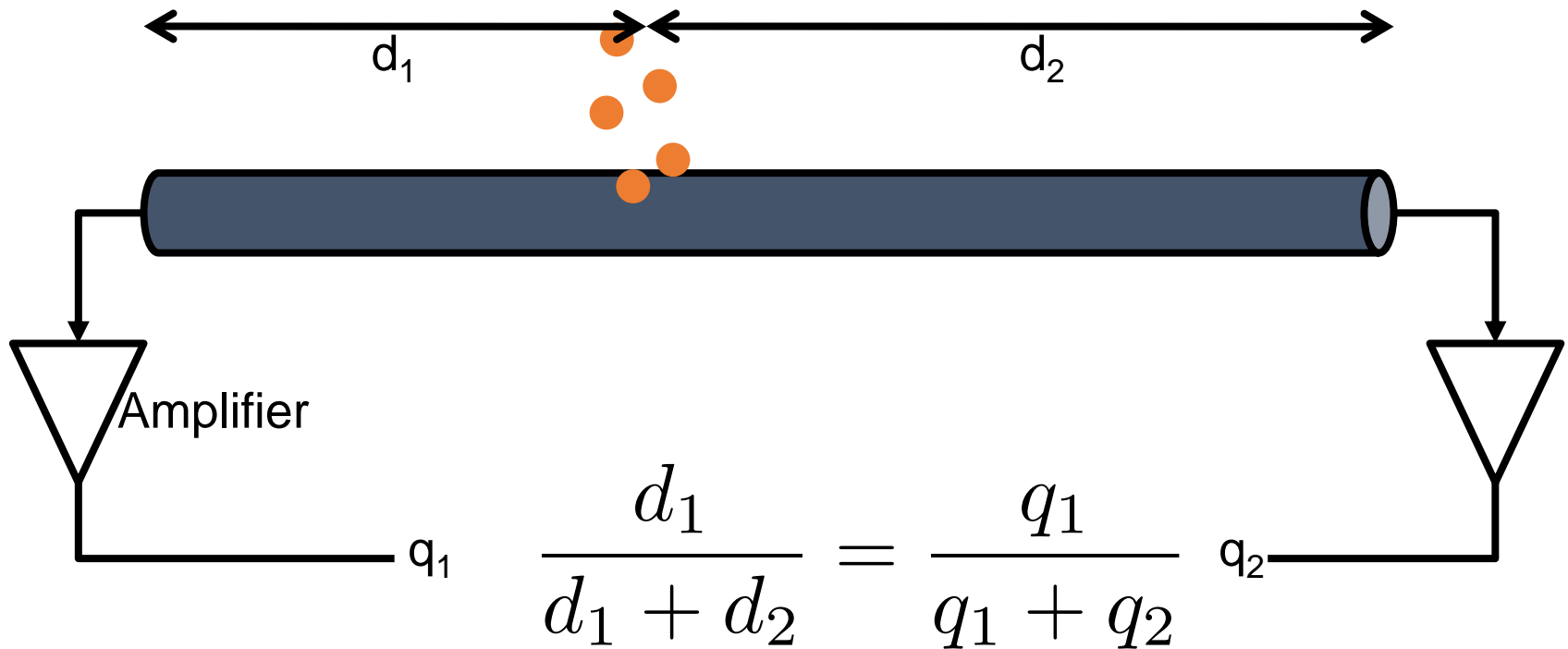

Real detectors, real problems

Dead time

- When a detector is processing an event, it cannot detect other photons for a certain amount of time

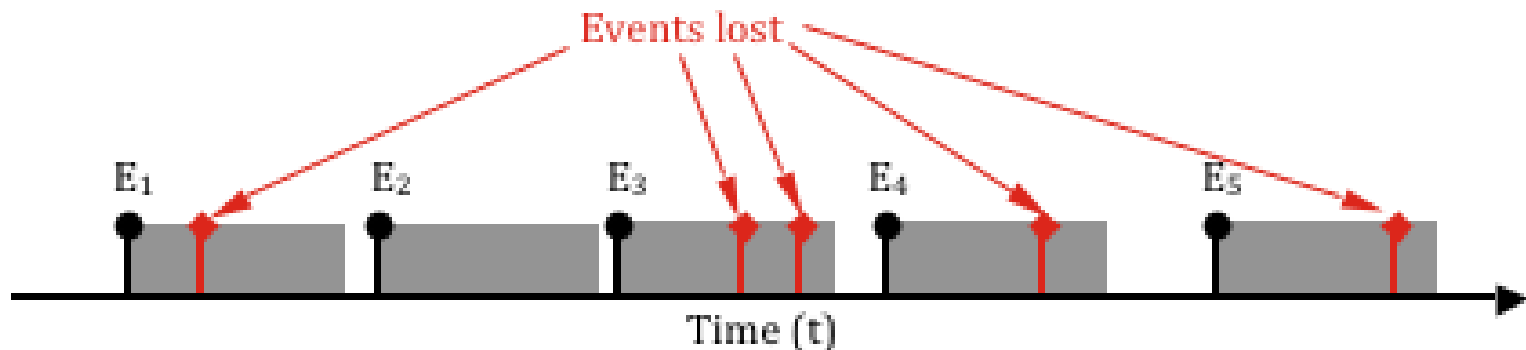

Conversion

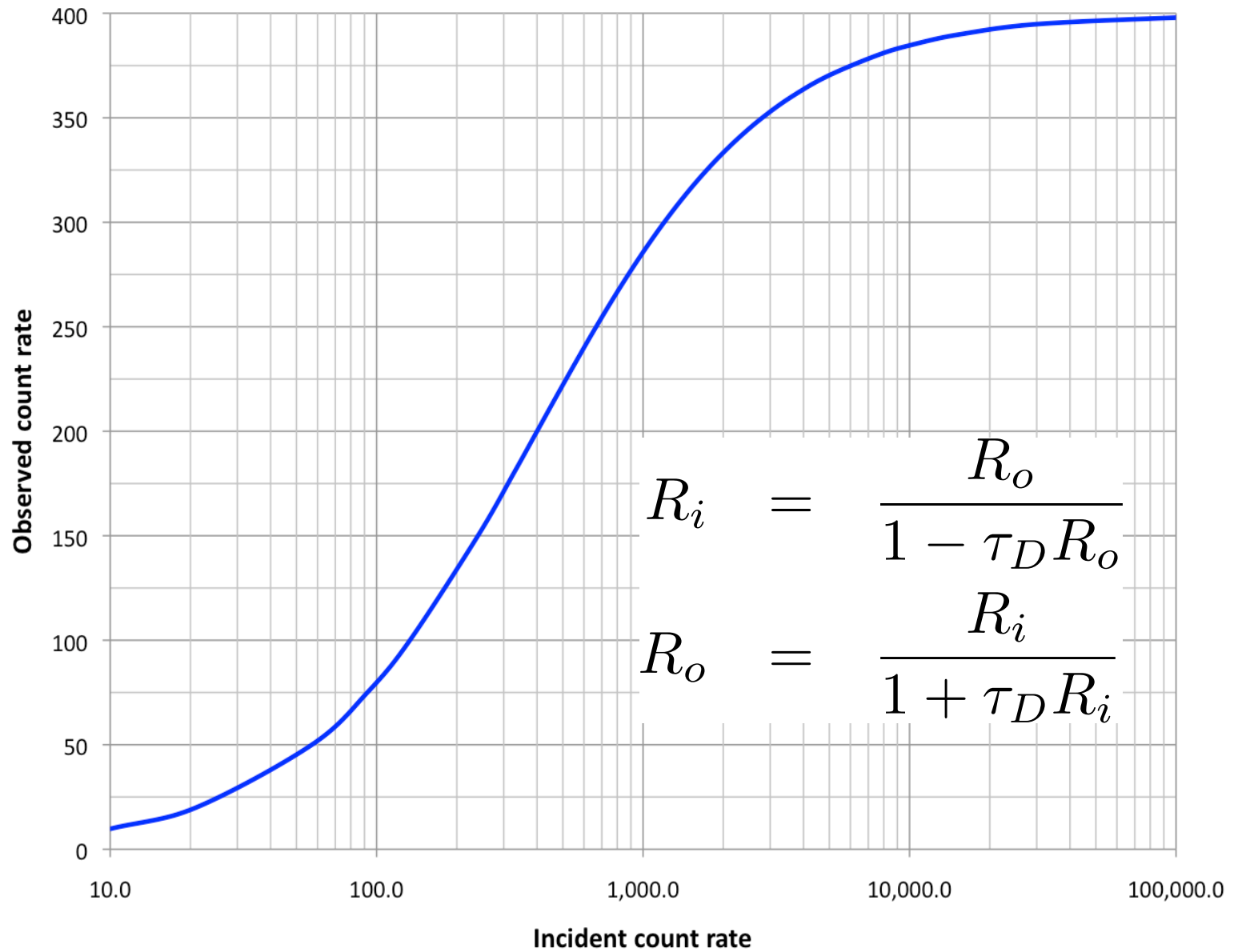

Pileup

- Each photon generates a pulse
- Pulse area \propto deposited charge
- What happens if a second pulse lands on top of it?
- Total charge = $C_1 + C_2$
- Inferred energy = $E_1 + E_2$

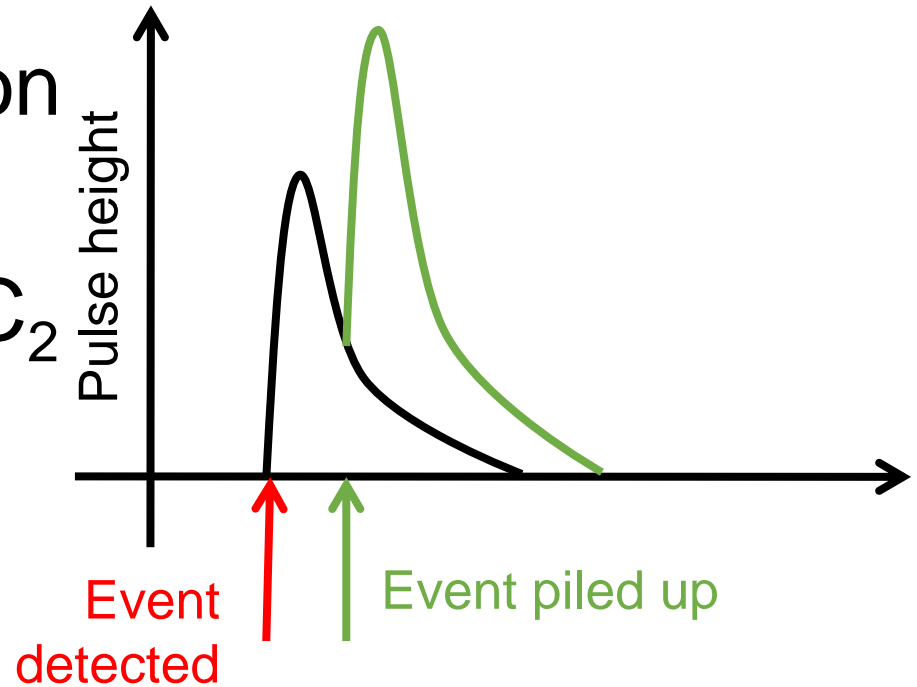

Dead time and pileup are different!

Smaller sampling window:
Lower chance of pileup
Poorer charge collection

Smaller sampling window:
Lower chance of pileup
Poorer charge collection

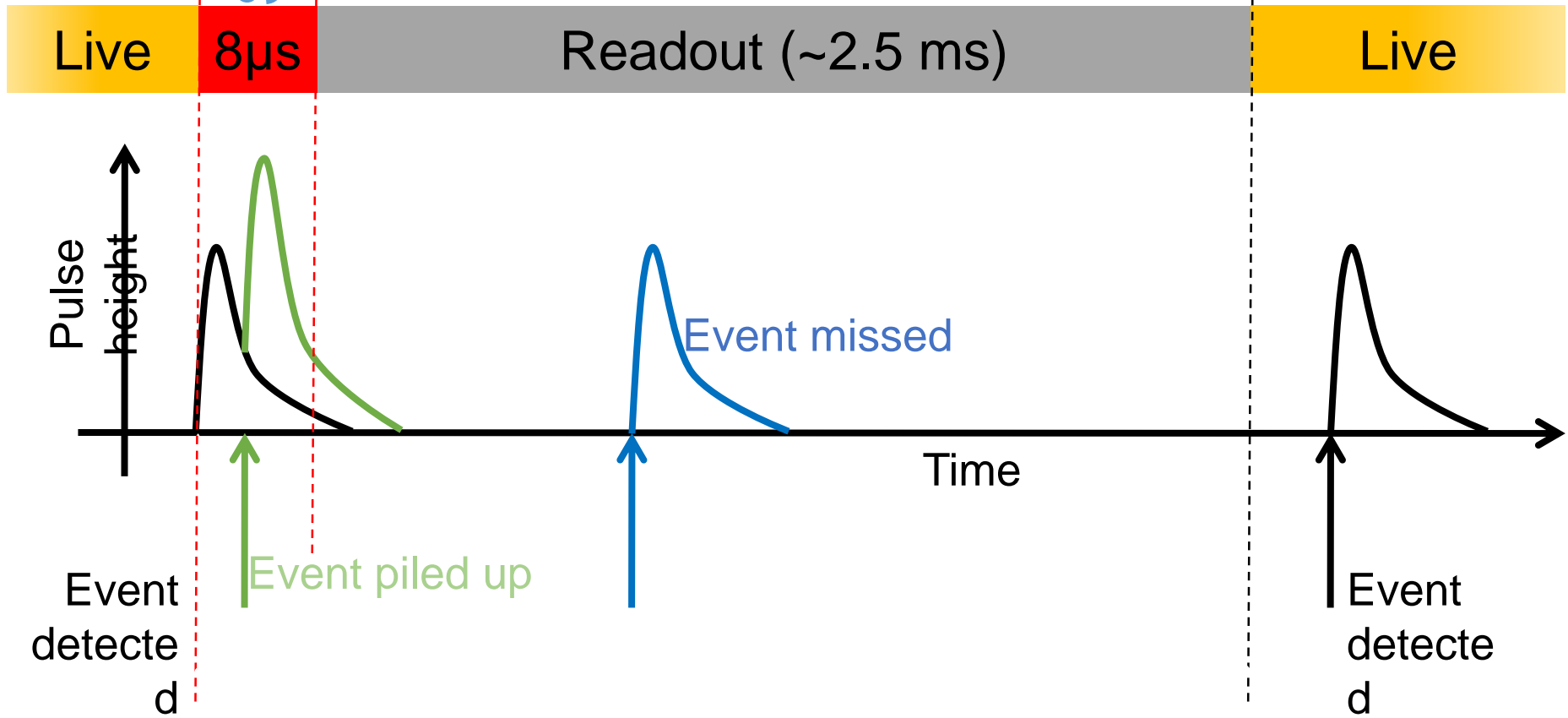

Spatial resolution

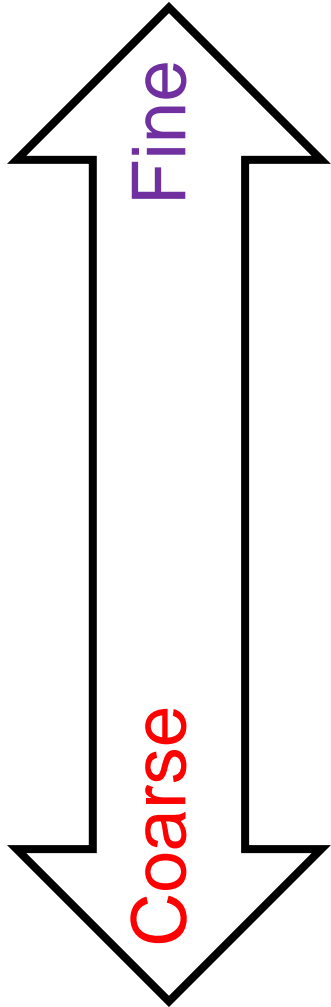

- Pixelled detectors – feasible for some solid state devices (CCD, CZT, CdTe)
- Silicon strip detectors, Silicon drift detectors
 - » Can be 1-D in some cases
- Proportional counters
- Scintillators / Ge detectors

Linearity

- What happens if a MeV photon interacts in
- CZT / Ge?
 - » High charge deposition
 - » Circuit saturates
- A gas proportional counter?
 - » Charge generation process becomes non-linear
- CCD?
 - » “Bleeding” – charge may spread to nearby pixels