

B-Physics at CMS

Nairit Sur

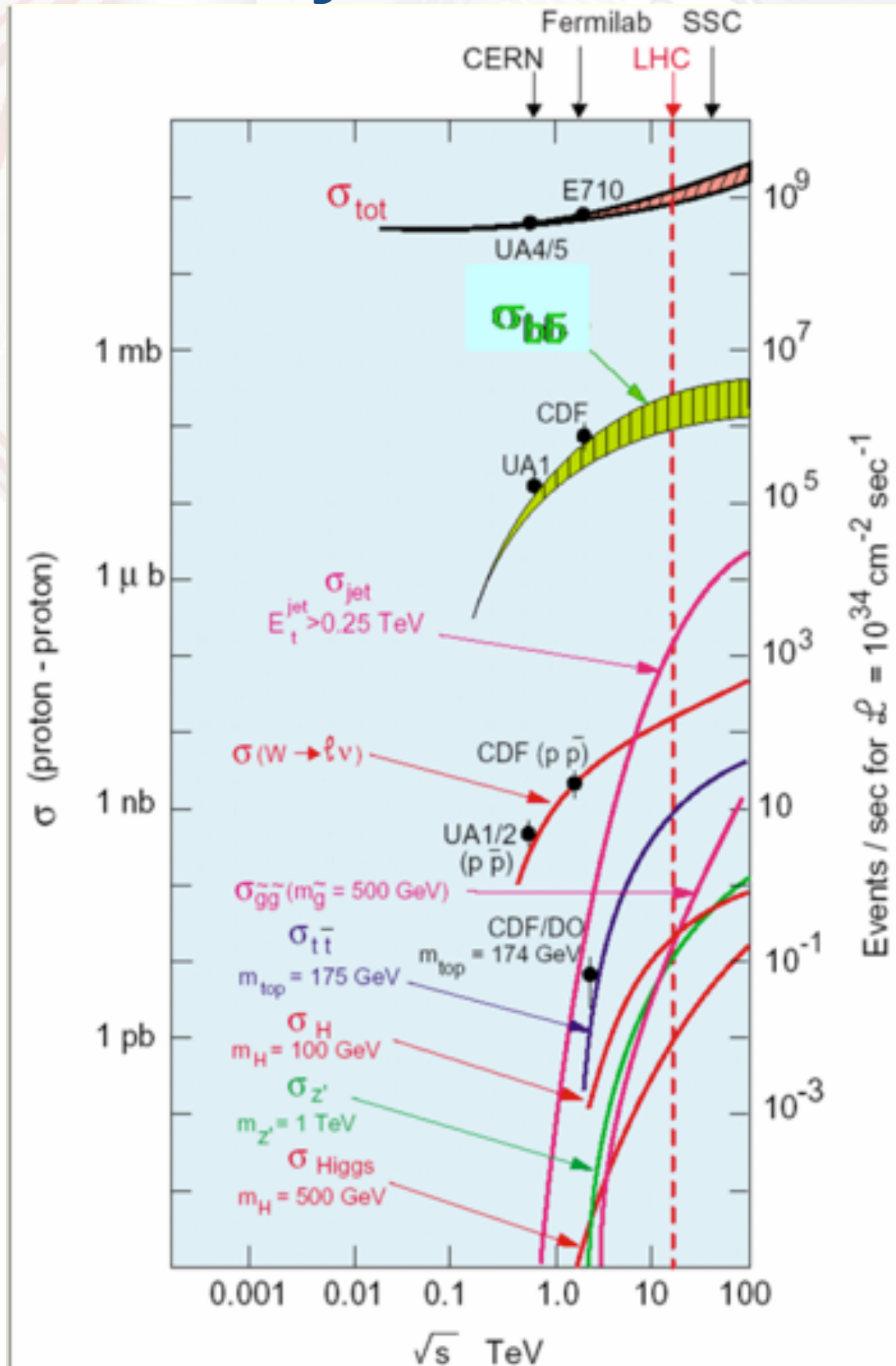

B Physics at the LHC : A Few Numbers



- **Energy** : 7 - 13 TeV pp
- σ_{total} : 100 mb (at 13 TeV)
- $\sigma_{\text{inelastic}}$: 80 mb (at 13 TeV)
- $\sigma_{b \text{ bbar}}$: 250 - 500 μb (7 - 13 TeV) = copious production of b hadrons
- **Bunch spacing** : 50 - 25 ns

ATLAS/CMS are complementary to **LHCb**

ATLAS/CMS	LHCb
Central Detector	Single arm forward detector
$\sim 1.5 \times 10^{34} \text{ cm}^{-2} \text{ s}^{-1}$	$2 \times 10^{32} \text{ cm}^{-2} \text{ s}^{-1}$
b bbar events per 10^7 sec : $5 \times 10^{12} \times \text{acceptance}$	b bbar events per 10^7 sec : $1 \times 10^{12} \times \text{acceptance}$
lepton only triggers for B Physics	both lepton and hadron triggers

CMS for B-Physics : Tracker

Silicon pixel detector:
66M readout channels
Each pixel: $100\ \mu\text{m} \times 150\ \mu\text{m}$

Silicon strips detector:
9M readout channels
Pitches: $80\text{-}180\ \mu\text{m}$

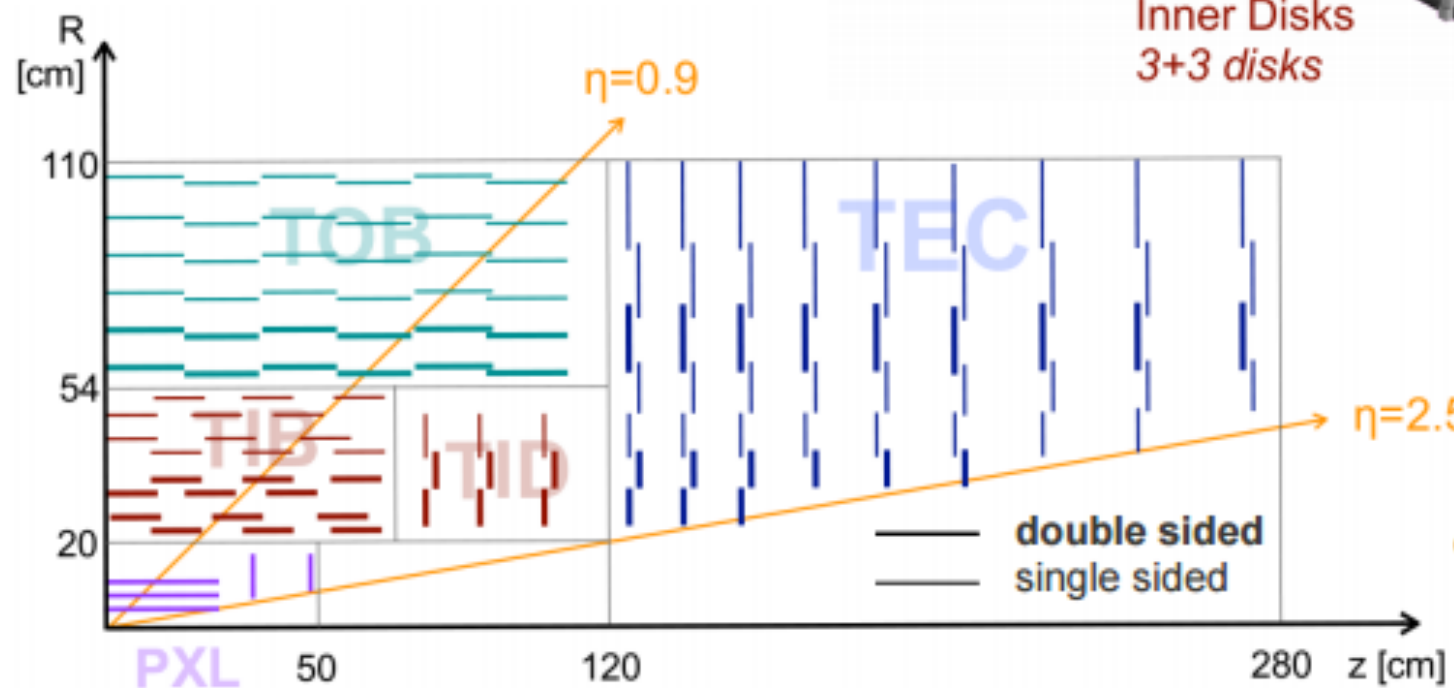
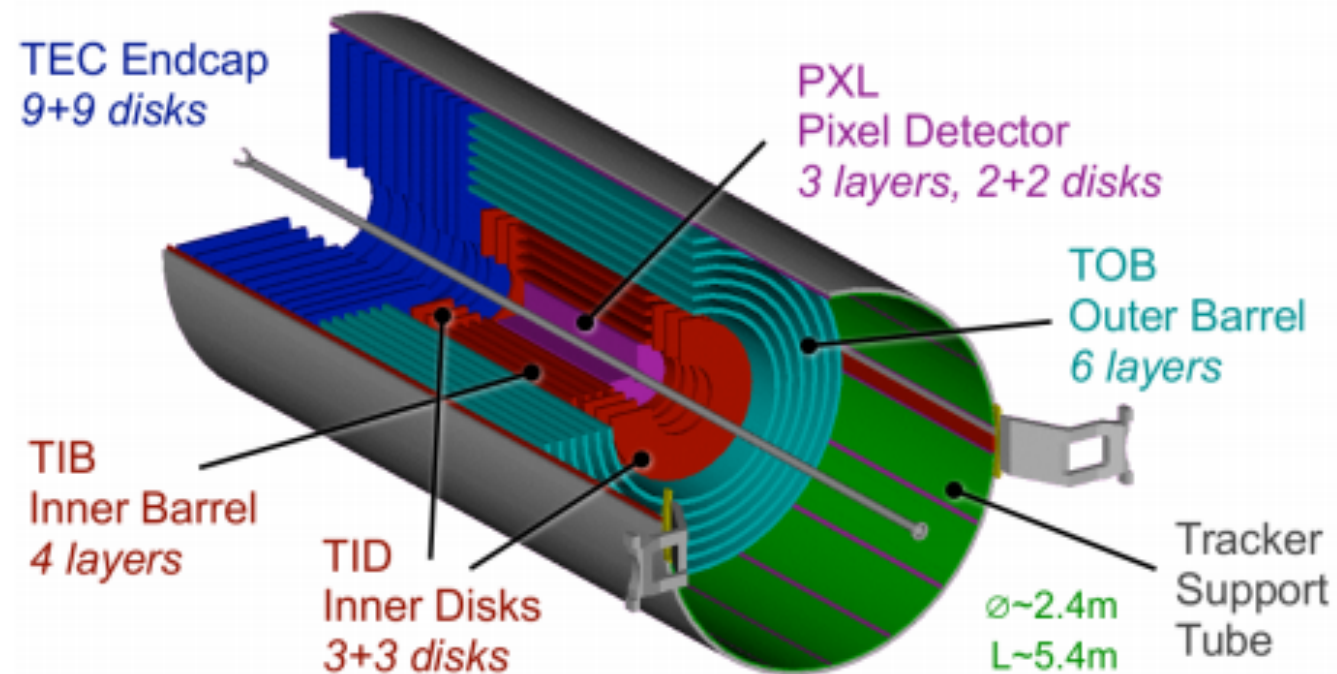

Axial B of 3.8 T

Performance:

$\sigma(pT)/pT \sim 1\text{-}2\%$ @ 100 GeV/c
 $\sigma(IP) \sim 10\text{-}20\ \mu\text{m}$ @ 10-100 GeV/c

Limited K/π separation by measuring dE/dx from analog readout of silicon strips for low energy tracks is possible but the lack of proper particle identification for hadrons remains a big caveat in CMS as far as B Physics is concerned

CMS for B-Physics : Muon Detectors

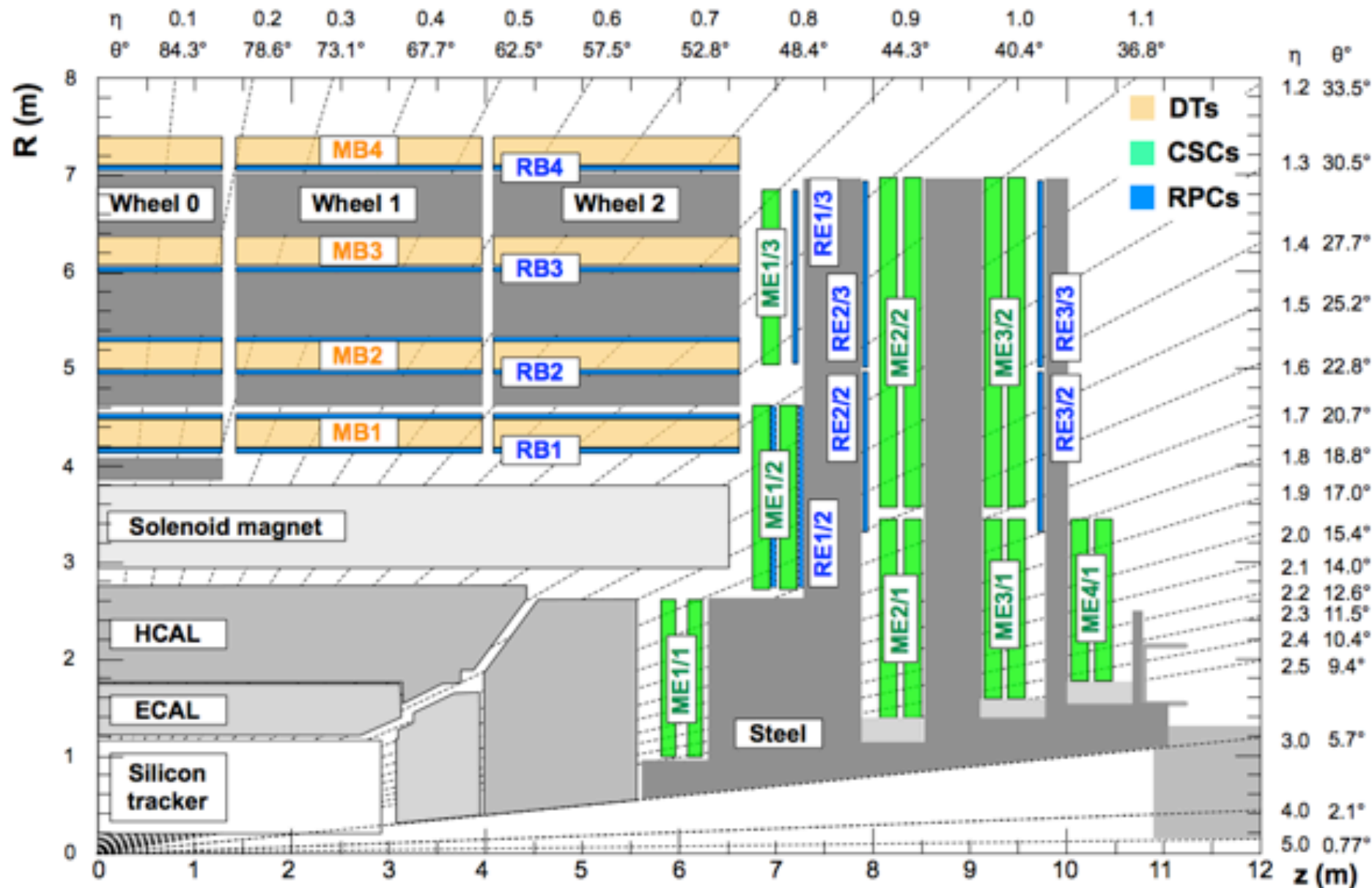

- **Drift Tubes (DT)** : Central coverage: $|\eta| < 1.2$, low particle rate, low magnetic field
- **Cathode Strip Chambers (CSC)** : Forward coverage: $0.9 < |\eta| < 2.4$, high non uniform magnetic field, high particle rate
- **Resistive Plate Chambers (RPC)** : Central and Forward coverage: $|\eta| < 2.1$, excellent time resolution

Muon System Goals :

1. Provide **independent muon tracking** to improve muon reconstruction, especially at high momenta
2. Provide a robust, redundant, independent **Level-1 trigger** for muons (\sim few GeV to 100 GeV), apply thresholds in muon momentum at trigger level, and perform bunch crossing (BX) identification
3. **No Dead-time allowed**: every BX must be processed

CMS for B-Physics : Trigger System

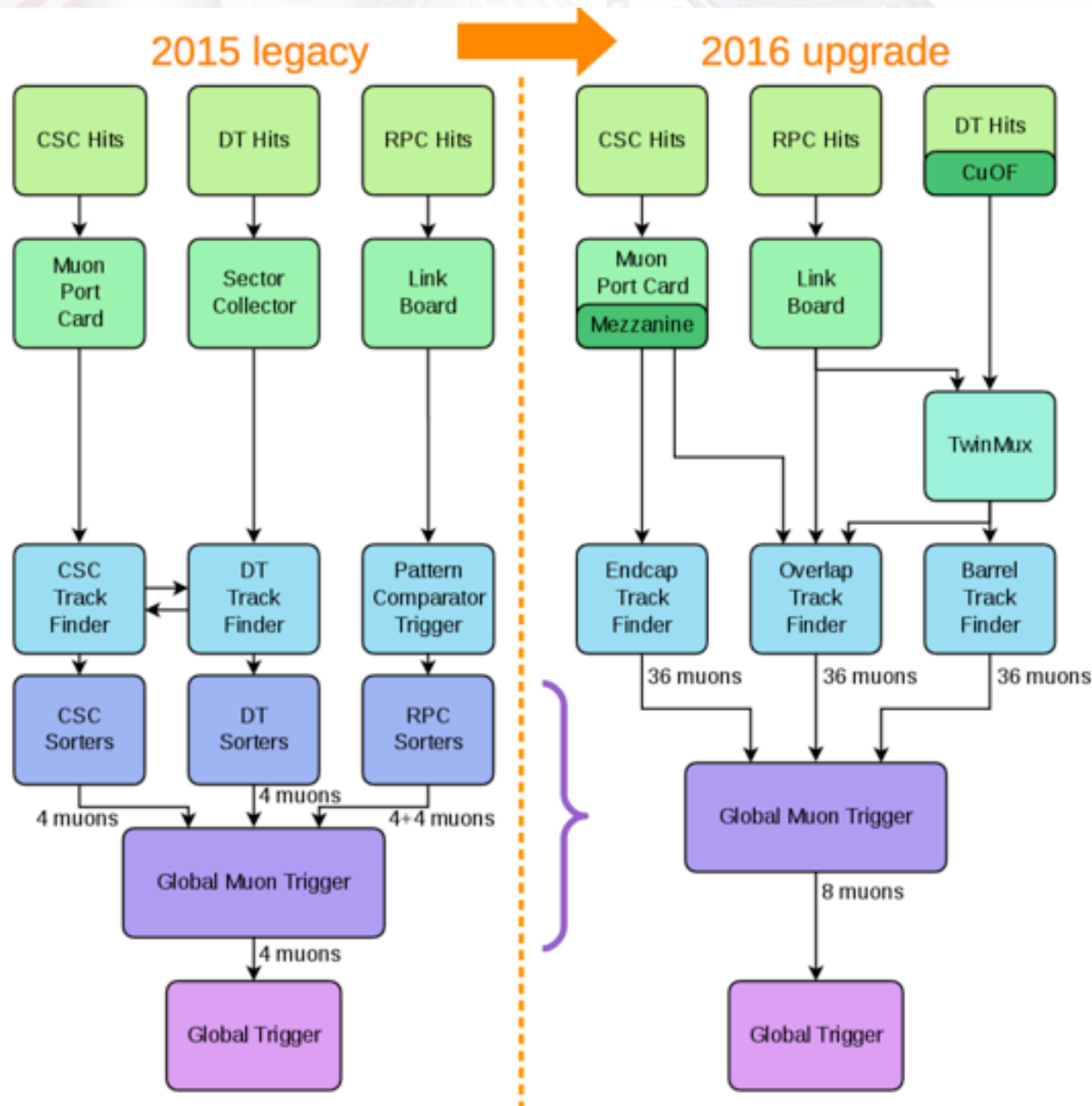

Level 1 (hardware) Trigger :

- RPC, CSC and DT provide muon candidates independently
- The Global Muon Trigger performs sorting, duplicate removal and calculates muon isolation for each BX, taking into account the quality of the candidates from each sub-system and sends best 8 muon candidates to the Global Trigger
- Global Trigger combines information from calorimeters to provide final L1 seeds

- reduces event rate from **40 MHz to 100 kHz**

High Level Trigger (HLT) :

- output event rate: **~ 1 kHz**
- aims to maximize efficiency while keeping CPU-time and rate low
- use the same software framework and most of the same reconstruction code used for offline reconstruction and analyses

CMS HLT Workflow : Looking for a Needle in a Needlestack

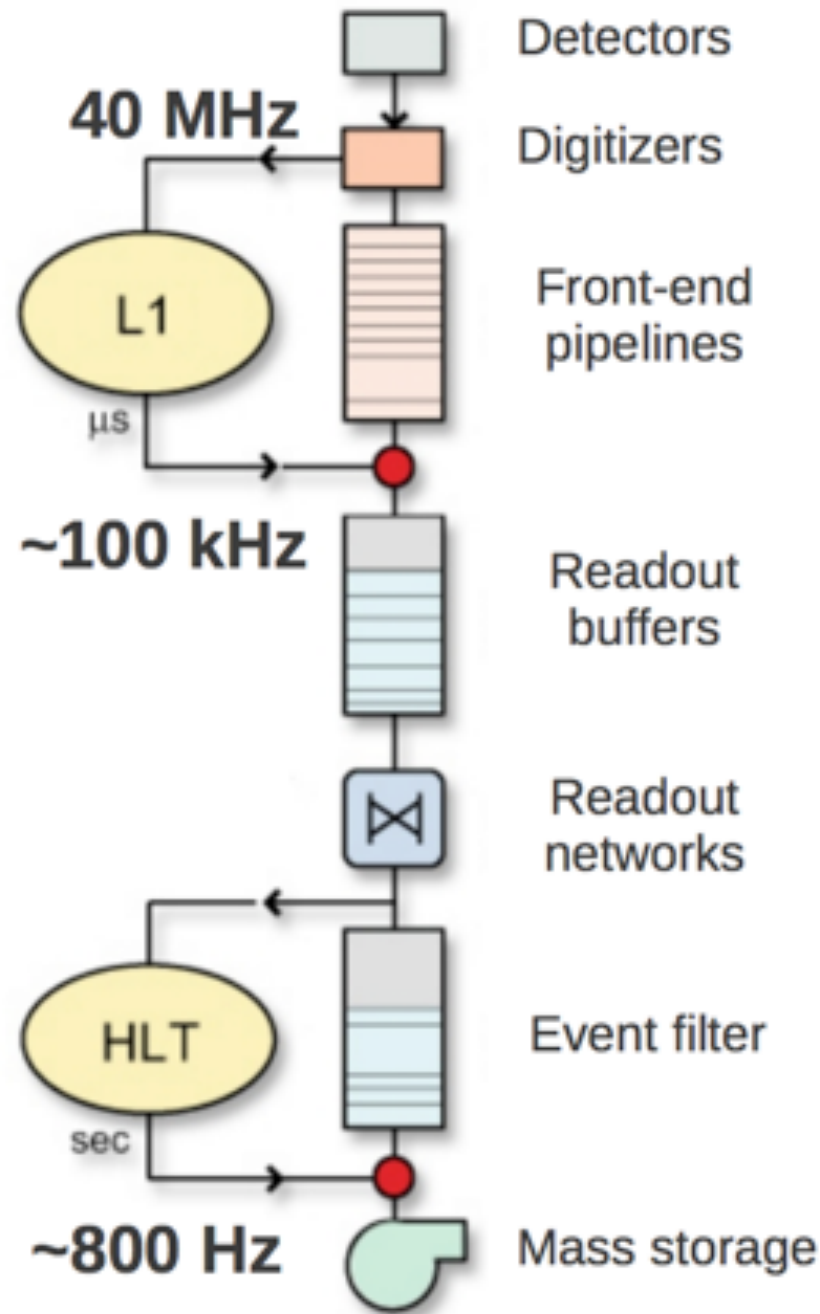

- **HLT**: starting from the L1 candidate, exploits also the tracker information .
N.B. Efforts are going on to have tracker only L1 triggers in Phase II of CMS

- Each HLT path is a sequence of reconstruction and selection steps of **increasing complexity**

- HLT code must be flexible to adapt to changes in data-taking conditions, like changes in luminosity or special conditions occurring during the CMS commissioning or dedicated LHC fills

- must provide on-line detector monitoring (\rightarrow specific trigger paths for calibration and alignment) and should be robust with respect to changes in alignment and calibration constants

- should be stable with respect to pile up

- The HLT decision is taken as the logical “OR” of many independent trigger “paths”

- each path runs independently from the others (in parallel)

- the CMS software framework guarantees that the same reconstruction block is not run twice

All trigger paths are always run.

The HLT decision is used to split the events into streams (data, calibration, monitoring - online) and dataset (offline)

The current HLT menu has ~600 independent paths

B-Physics Trigger Space at CMS

Pure rates

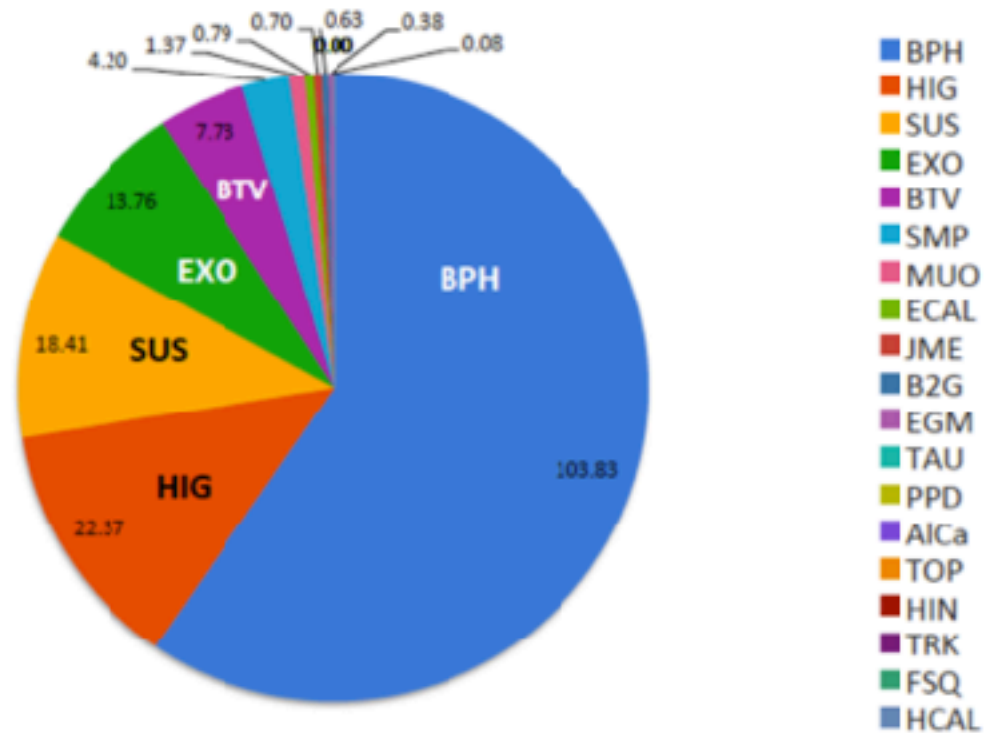

- B Physics has different and peculiar needs and hence our trigger space is quite pure (same events rarely triggered by other paths)
- With ever increasing luminosity at the LHC, it is very difficult to keep a low pT threshold for triggered muons due to hardware and computational limitations.
- B Physics group exploits correlations at the L1 level to keep the rate under control even with lower pT thresholds.
- Eta restrictions are already in place and efforts are going on to implement invariant mass cuts at the L1 level

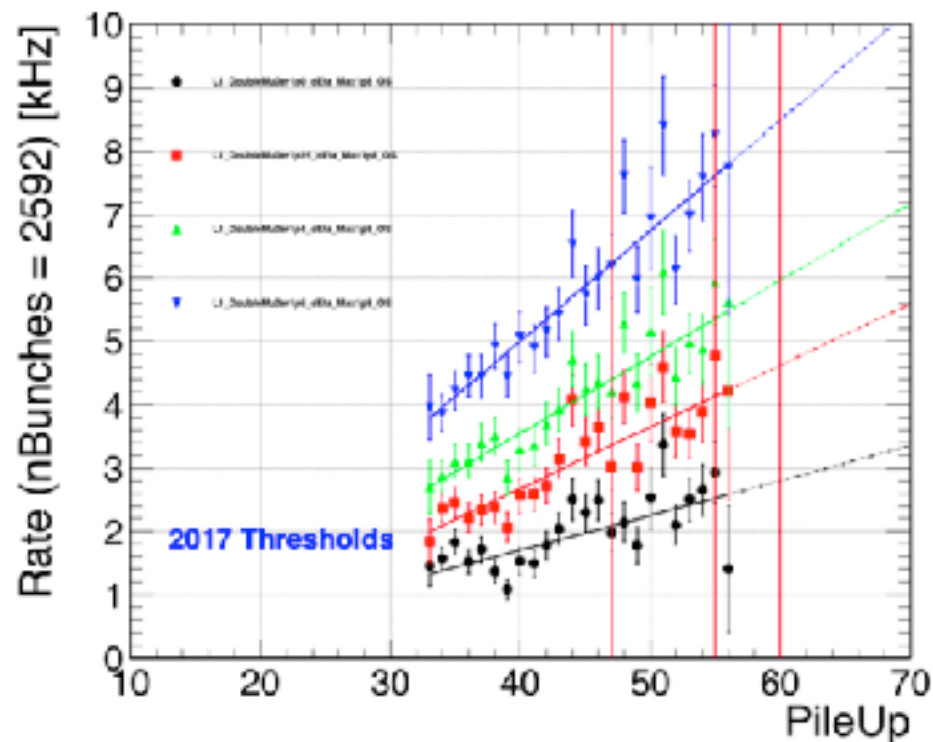

L1_DoubleMu0er1p0_dEta_Max1p8_OS
L1_DoubleMu0er1p25_dEta_Max1p8_OS
L1_DoubleMu0er1p4_dEta_Max1p8_OS
L1_DoubleMu0er1p6_dEta_Max1p8_OS

Charmonium Paths

HLT Paths	L1 Seed
HLT_Dimuon0_Jpsi_Muon	L1_TripleMu0 OR L1_TripleMu_5_0_0
HLT_Dimuon0er16_Jpsi_NoOS_NoVertexing	L1_DoubleMu0er1p6_dEta_Max1p8
HLT_Dimuon0er16_Jpsi_NoVertexing	L1_DoubleMu0er1p6_dEta_Max1p8_OS
HLT_Dimuon10_Jpsi_Barrel	L1_DoubleMu0er1p6_dEta_Max1p8_OS OR L1_DoubleMu0er1p4_dEta_Max1p8_OS
HLT_Dimuon13_PsiPrime	L1_DoubleMu_10_0_dEta_Max1p8 OR L1_DoubleMu_11_4 OR L1_DoubleMu_12_5 OR L1_DoubleMu_13_6
HLT_Dimuon16_Jpsi	L1_DoubleMu_10_0_dEta_Max1p8 OR L1_DoubleMu_11_4 OR L1_DoubleMu_12_5 OR L1_DoubleMu_13_6
HLT_Dimuon20_Jpsi	L1_DoubleMu_10_0_dEta_Max1p8 OR L1_DoubleMu_11_4 OR L1_DoubleMu_12_5 OR L1_DoubleMu_13_6
HLT_Dimuon6_Jpsi_NoVertexing	L1_DoubleMu0
HLT_Dimuon8_PsiPrime_Barrel	L1_DoubleMu0er1p6_dEta_Max1p8_OS OR L1_DoubleMu0er1p4_dEta_Max1p8_OS
HLT_DoubleMu4_3_Bs	L1_DoubleMu_10_0_dEta_Max1p8 OR L1_DoubleMu0er1p6_dEta_Max1p8_OS OR L1_DoubleMu0er1p4_dEta_Max1p8_OS OR L1_DoubleMu_11_4 OR L1_DoubleMu_12_5 OR L1_DoubleMu_13_6
HLT_DoubleMu4_3_Jpsi_Displaced	L1_DoubleMu_10_0_dEta_Max1p8 OR L1_DoubleMu0er1p6_dEta_Max1p8_OS OR L1_DoubleMu0er1p4_dEta_Max1p8_OS OR L1_DoubleMu_11_4 OR L1_DoubleMu_12_5 OR L1_DoubleMu_13_6
HLT_DoubleMu4_JpsiTrk_Displaced	L1_DoubleMu_10_0_dEta_Max1p8 OR L1_DoubleMu0er1p6_dEta_Max1p8_OS OR L1_DoubleMu0er1p4_dEta_Max1p8_OS OR L1_DoubleMu_11_4 OR L1_DoubleMu_12_5 OR L1_DoubleMu_13_6
HLT_DoubleMu4_PsiPrimeTrk_Displaced	L1_DoubleMu_10_0_dEta_Max1p8 OR L1_DoubleMu0er1p6_dEta_Max1p8_OS OR L1_DoubleMu0er1p4_dEta_Max1p8_OS OR L1_DoubleMu_11_4 OR L1_DoubleMu_12_5 OR L1_DoubleMu_13_6
HLT_Mu7p5_L2Mu2_Jpsi	L1_DoubleMu0
HLT_Mu7p5_Track2_Jpsi	L1_SingleMu5 OR L1_SingleMu7
HLT_Mu7p5_Track3p5_Jpsi	L1_SingleMu5 OR L1_SingleMu7
HLT_Mu7p5_Track7_Jpsi	L1_SingleMu5 OR L1_SingleMu7
HLT_QuadMuon0_Dimuon0_Jpsi	L1_QuadMu0

MuOnia Paths

HLT Paths	L1 Seed
HLT_Dimuon0_Phi_Barrel	L1_DoubleMu0er1p6_dEta_Max1p8_OS OR L1_DoubleMu0er1p4_dEta_Max1p8_OS
HLT_Dimuon0_Upsilon_Muon	L1_TripleMu0 OR L1_TripleMu_5_0_0
HLT_Dimuon13_Upsilon	L1_DoubleMu_10_0_dEta_Max1p8 OR L1_DoubleMu_11_4 OR L1_DoubleMu_12_5 OR L1_DoubleMu_13_6
HLT_Dimuon8_Upsilon_Barrel	L1_DoubleMu0er1p6_dEta_Max1p8_OS OR L1_DoubleMu0er1p4_dEta_Max1p8_OS
HLT_Mu16_TkMu0_dEta18_Onia	L1_SingleMu14er OR L1_SingleMu16
HLT_Mu16_TkMu0_dEta18_Phi	L1_SingleMu14er OR L1_SingleMu16
HLT_Mu25_TkMu0_dEta18_Onia	L1_SingleMu20 OR L1_SingleMu22 OR L1_SingleMu25 OR L1_SingleMu20er
HLT_Mu7p5_L2Mu2_Upsilon	L1_DoubleMu0
HLT_Mu7p5_Track2_Upsilon	L1_SingleMu5 OR L1_SingleMu7
HLT_Mu7p5_Track3p5_Upsilon	L1_SingleMu5 OR L1_SingleMu7
HLT_Mu7p5_Track7_Upsilon	L1_SingleMu5 OR L1_SingleMu7
HLT_QuadMuon0_Dimuon0_Upsilon	L1_QuadMu0

DoubleMuon and DoubleMuonLowMass Paths

HLT Paths	L1 Seed
HLT_DoubleMu3_Trk_Tau3mu	L1_DoubleMu0er1p6_dEta_Max1p8_OS OR L1_DoubleMu0er1p4_dEta_Max1p8_OS OR L1_DoubleMu_10_0_dEta_Max1p8 OR L1_DoubleMu_11_4 OR L1_TripleMu0 OR L1_TripleMu_5_0_0
HLT_DoubleMu4_LowMassNonResonantTrk_Displaced	L1_DoubleMu_10_0_dEta_Max1p8 OR L1_DoubleMu0er1p6_dEta_Max1p8_OS OR L1_DoubleMu0er1p4_dEta_Max1p8_OS OR L1_DoubleMu_11_4 OR L1_DoubleMu_12_5 OR L1_DoubleMu_13_6
HLT_DoubleMu0	L1_DoubleMu0er1p6_dEta_Max1p8

The DiMuon Invariant Mass - ICHEP 2016

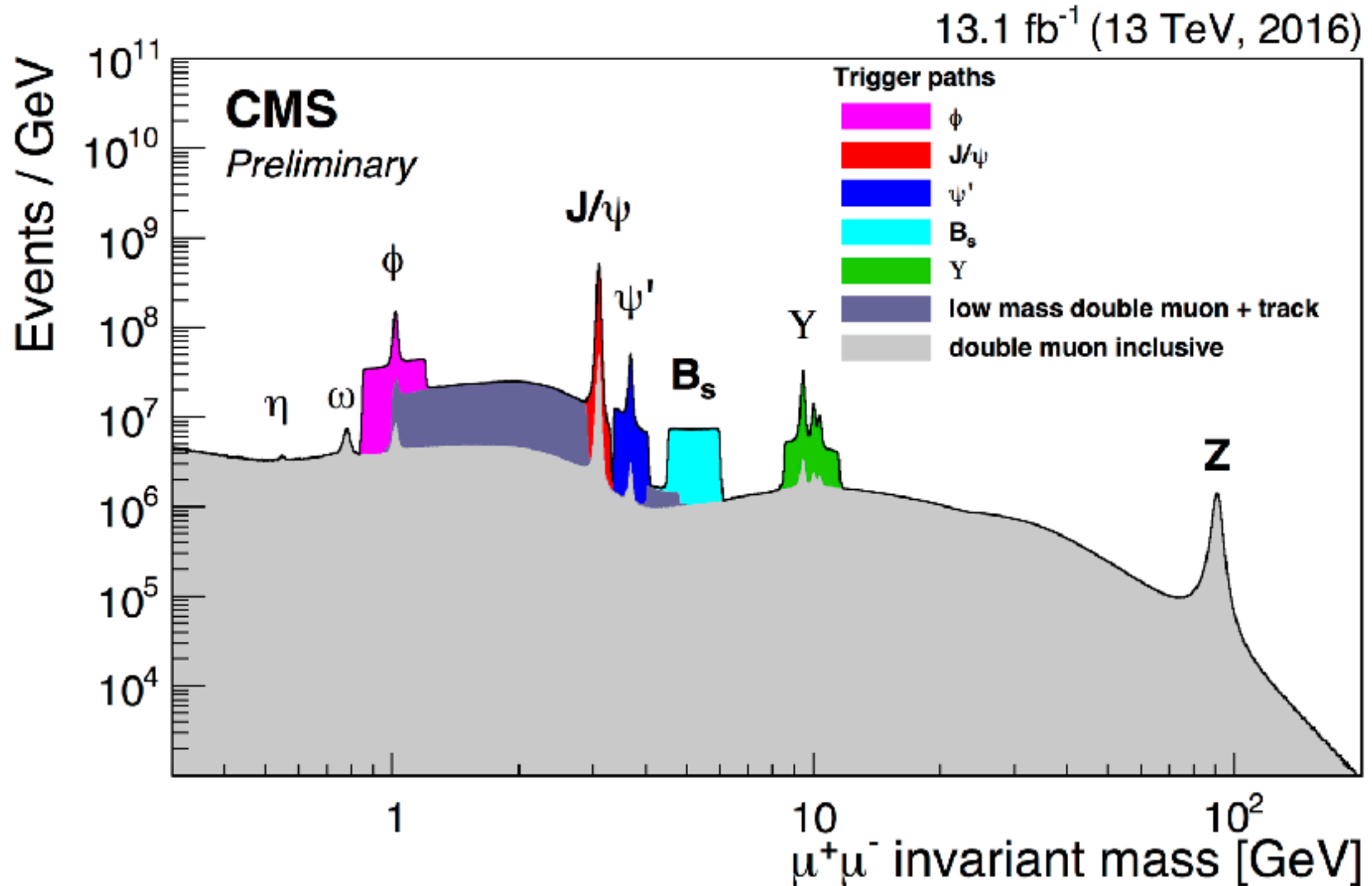

Dimuon mass distribution collected with various dimuon triggers at 13 TeV in 2016 with 13.1fb⁻¹. The coloured paths correspond to dedicated dimuon triggers with low pT thresholds, in specific mass windows, while the light gray continuous distribution represents events collected with a dimuon trigger with high pT thresholds

The DiMuon Invariant Mass - 2011

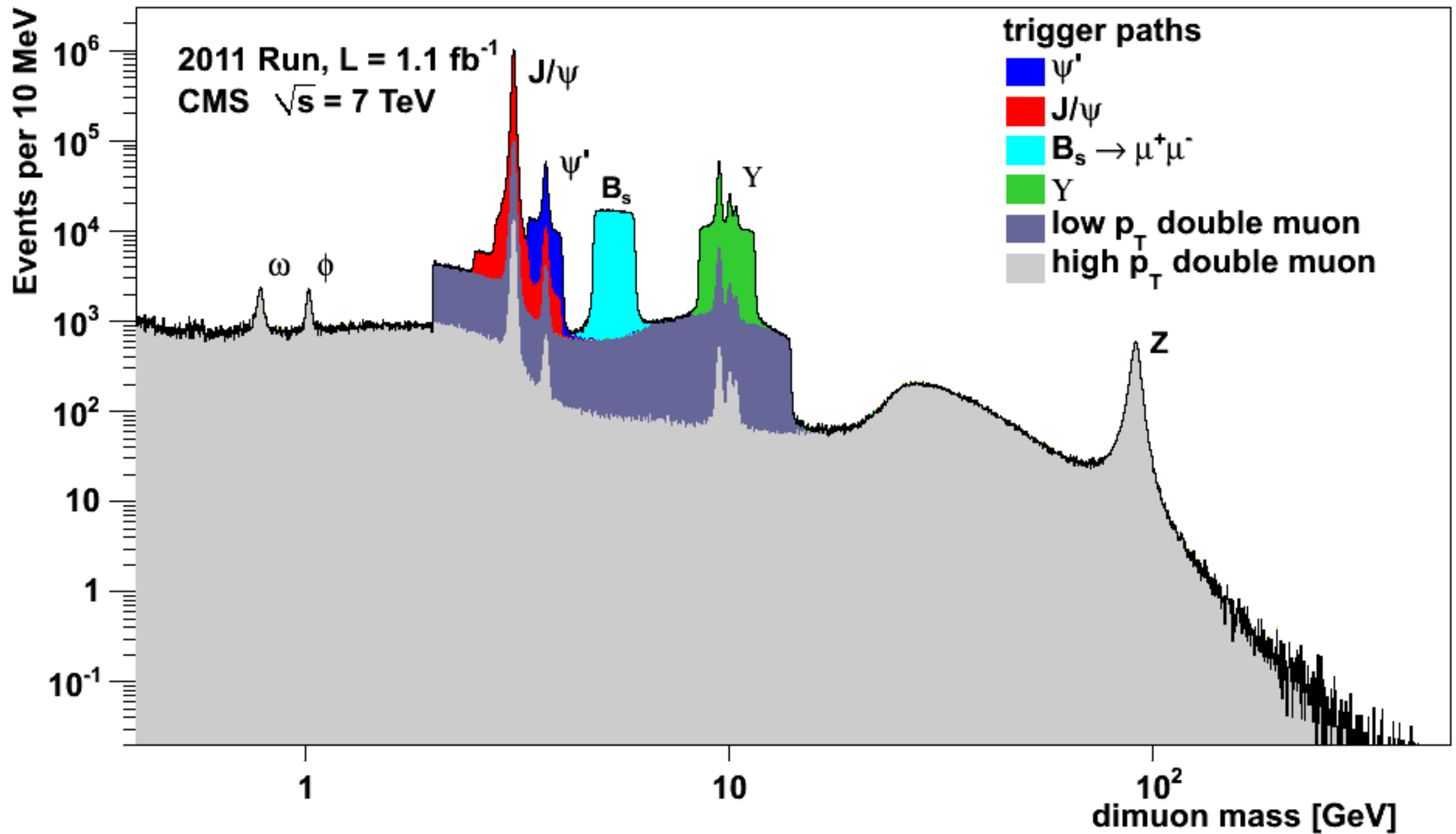

CMS B Physics Performance

Dimuon invariant mass in vicinity of $\phi(1020)$, detector barrel region

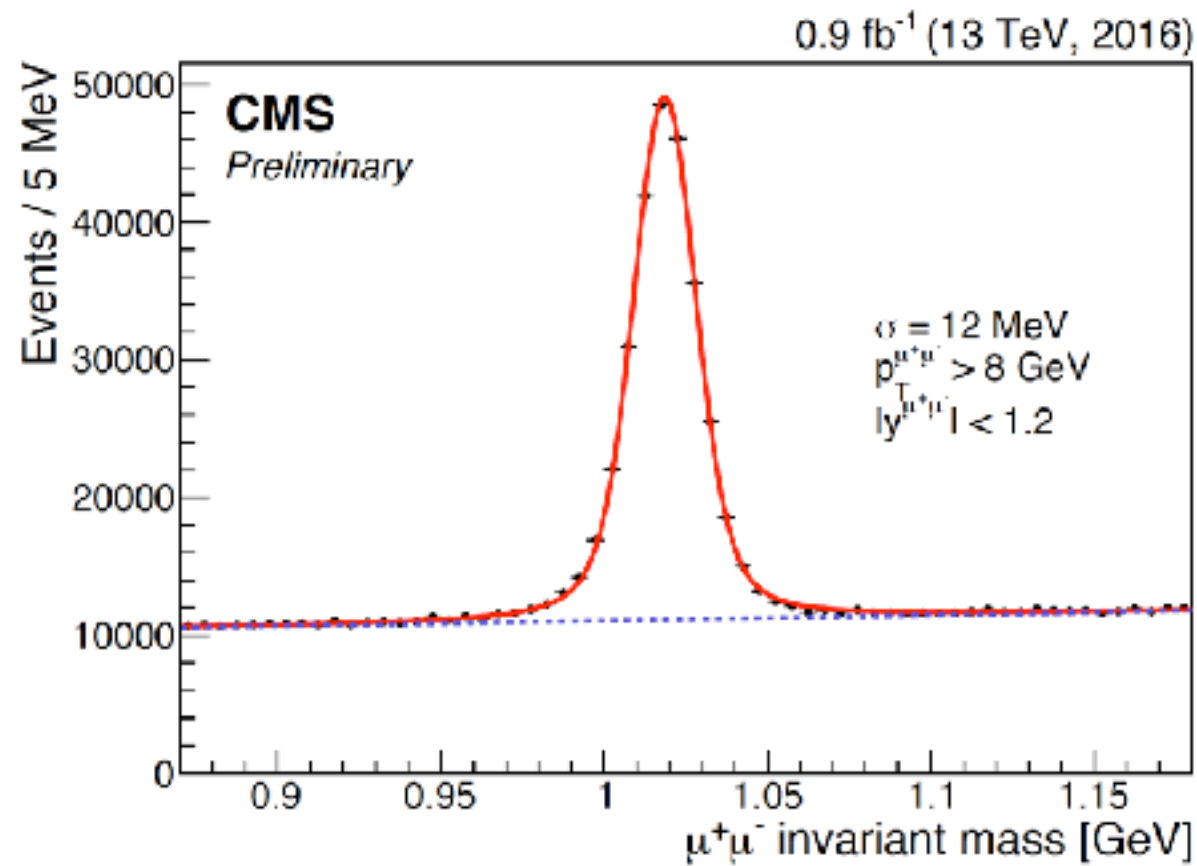

Dimuon invariant mass in vicinity of $\psi(2S)$

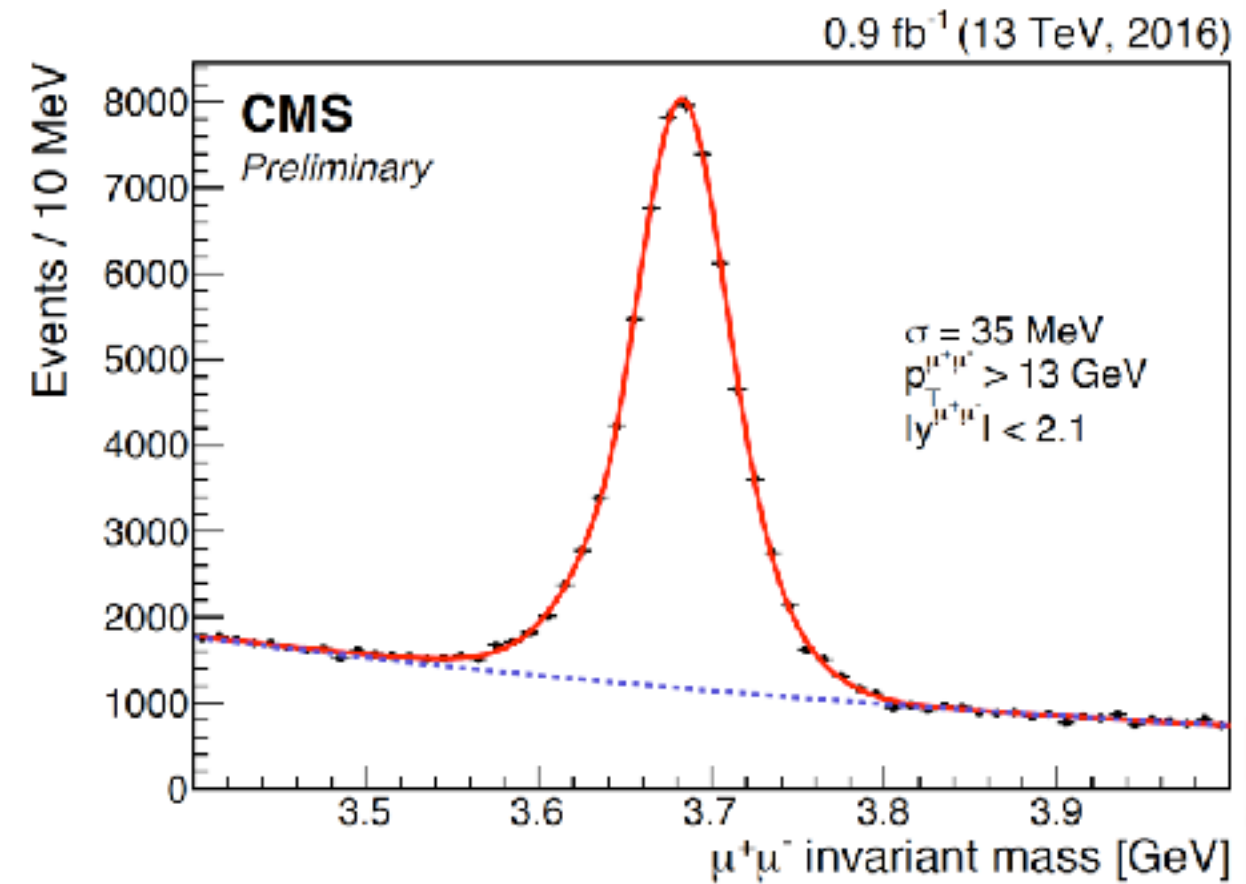

CMS B Physics Performance

Inclusive J/ψ trigger with $p_T > 16$ GeV

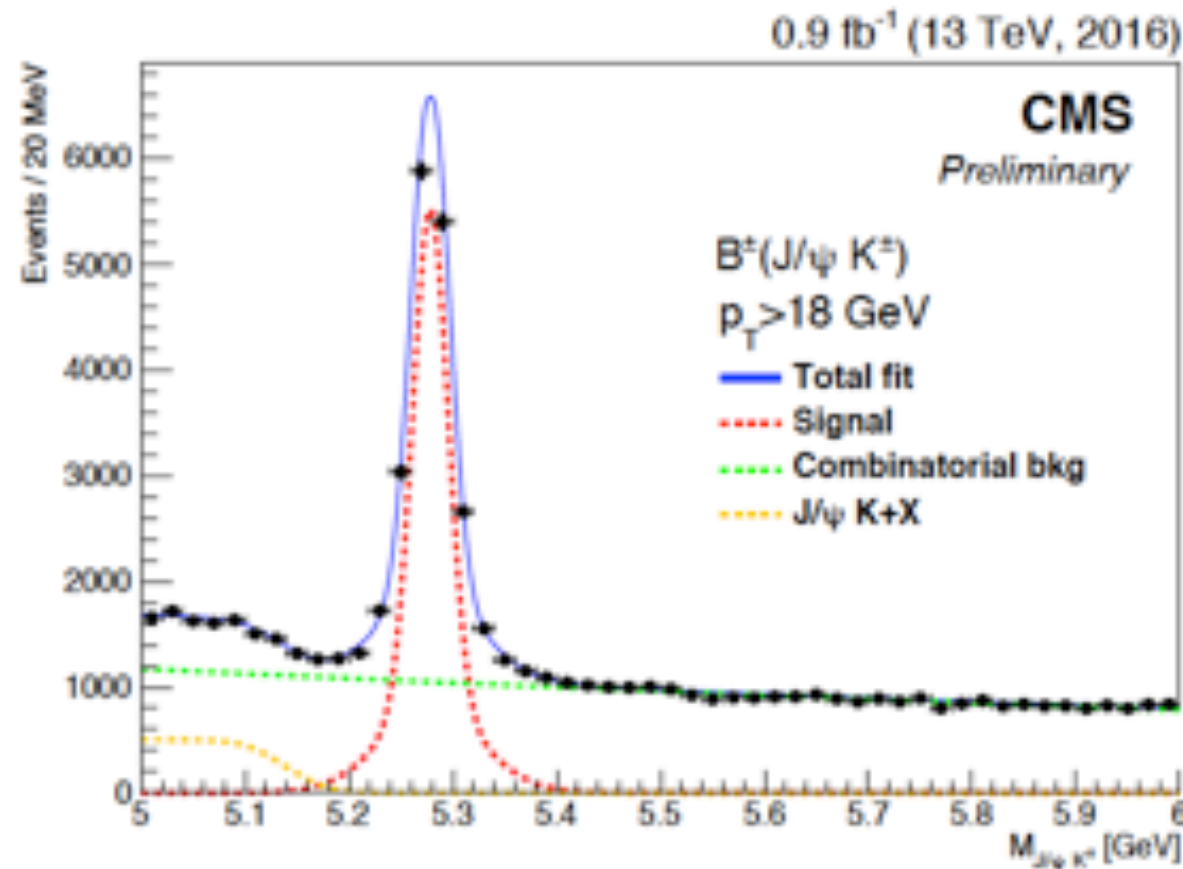

$$B^\pm \rightarrow J/\psi K^\pm$$

2D (mass [M], proper time [ct])
fit: mass projection

Quality cuts:

$$p_T(K^\pm) > 2.0 \text{ GeV}$$

$$\text{Vertex probability} > 15\%$$

$$p_T(J/\psi) > 16 \text{ GeV}$$

PDF shape:

- Signal: double Gaussian
- Combinatorial background: exponential
- $J/\psi K+X$: Error function

$$\text{Mass: } 5.278 \pm 0.001 \text{ (stat) GeV}$$

CMS B Physics Performance

Inclusive J/ψ trigger with $p_T > 16$ GeV

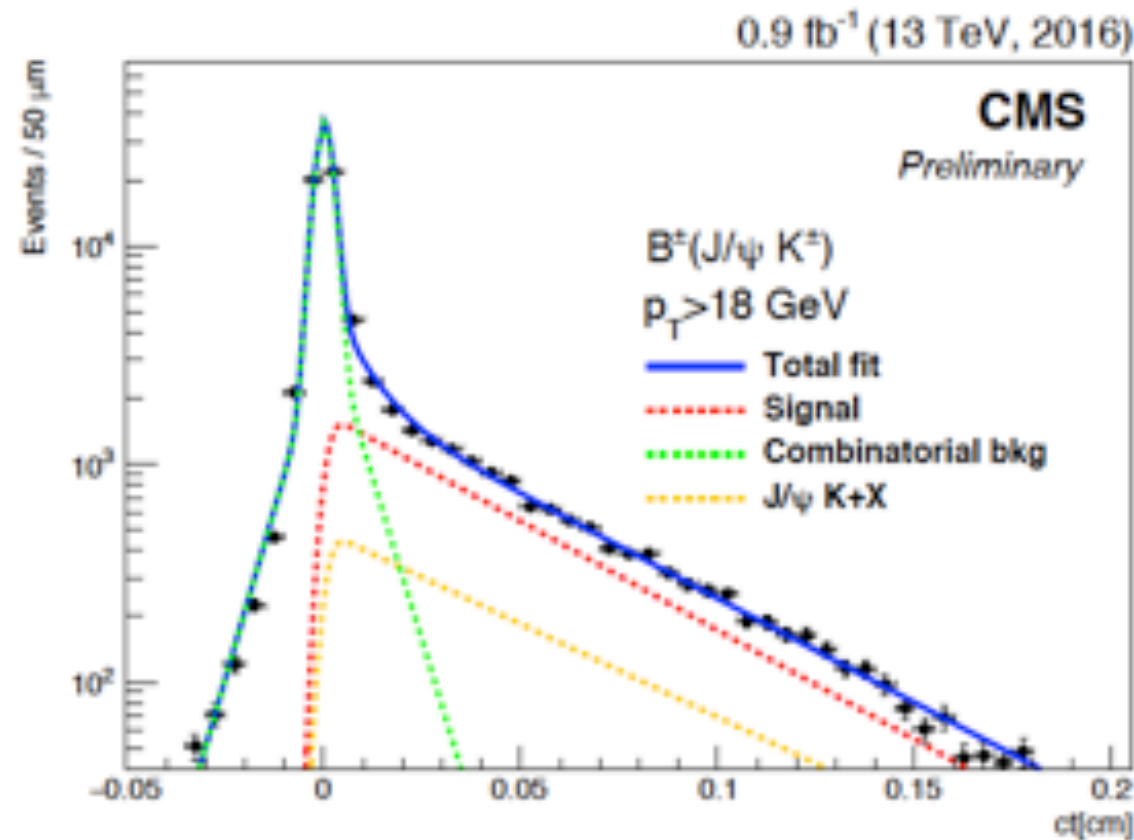

$B^\pm \rightarrow J/\psi K^\pm$

2D (mass [M], proper time [ct])
fit: proper time projection

PDF shape for ct distribution:

- Decaying exponential terms: $e^{-ct/\lambda}$ convolved with a Gaussian resolution function using per-event uncertainties
- Signal, $J/\psi K^+ X$ background: decaying exponential function
- Combinatoric background: prompt Gaussian + decaying exponential function

CMS B Physics Performance

Displaced J/ψ + track trigger

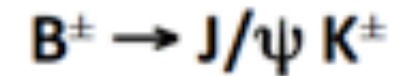
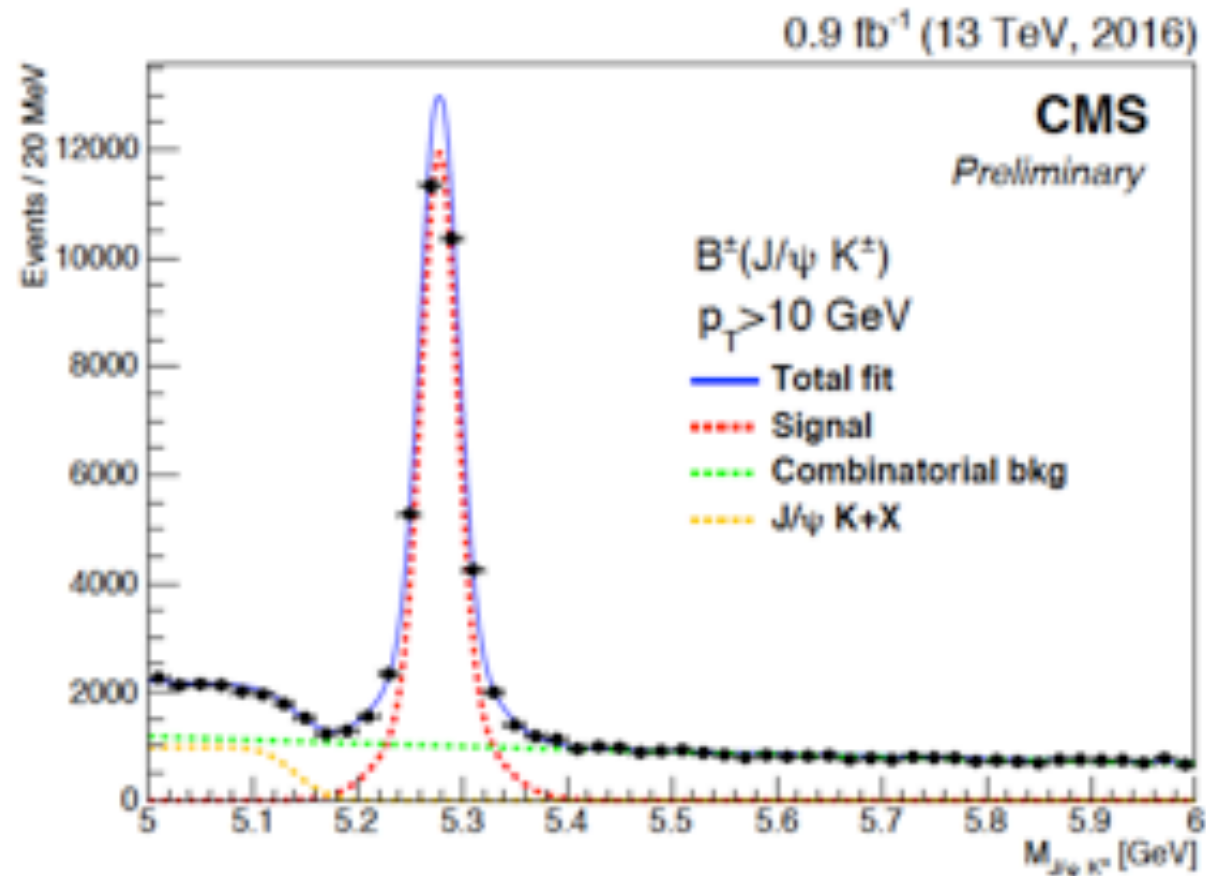

1D (mass [M] fit)

Quality cuts:

$$\cos \alpha > 0.99$$

$$|x_{xy}|/\sigma(|x_{xy}|) > 3.0$$

Vertex probability > 10%

$$p_T(J/\psi) > 8 \text{ GeV}$$

$$p_T(K) > 1.6 \text{ GeV}$$

PDF shape:

- Signal: double Gaussian
- Combinatorial background: exponential
- $J/\psi K+X$: Error function

Mass: 5.278 ± 0.001 (stat) GeV

CMS B Physics Performance

Displaced J/ψ + track trigger

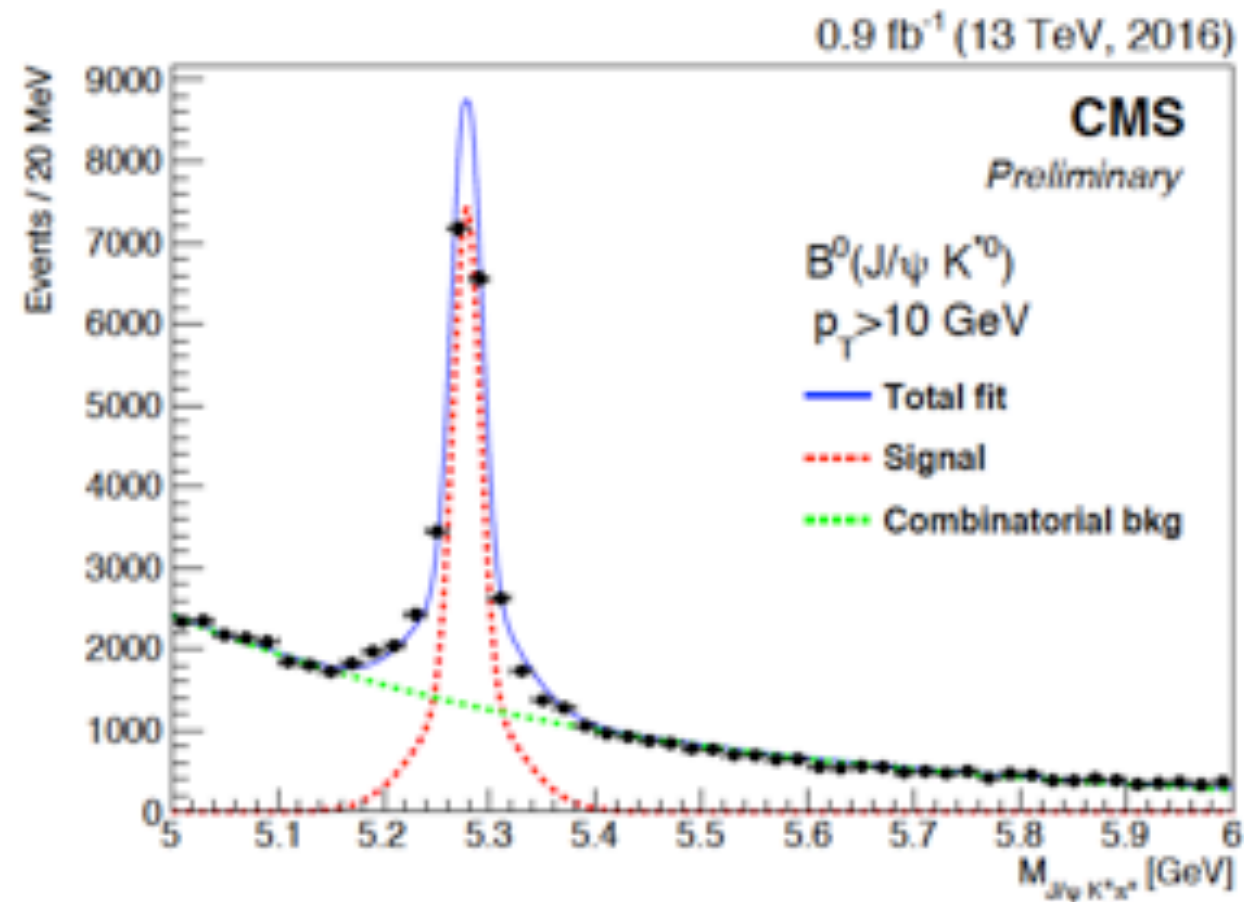

$B^0 \rightarrow J/\psi K^{*0}$
1D (mass [M] fit)

Quality cuts:

$\cos \alpha > 0.99$

$l_{xy}/\sigma(l_{xy}) > 3.0$

Vertex probability > 10%

$p_T(J/\psi) > 8$ GeV

PDF shape:

- Signal: double Gaussian
- Combinatorial background: exponential

Mass: 5.278 ± 0.001 (stat) GeV

CMS B Physics Performance

Displaced J/ψ + track trigger

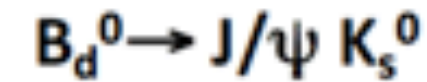
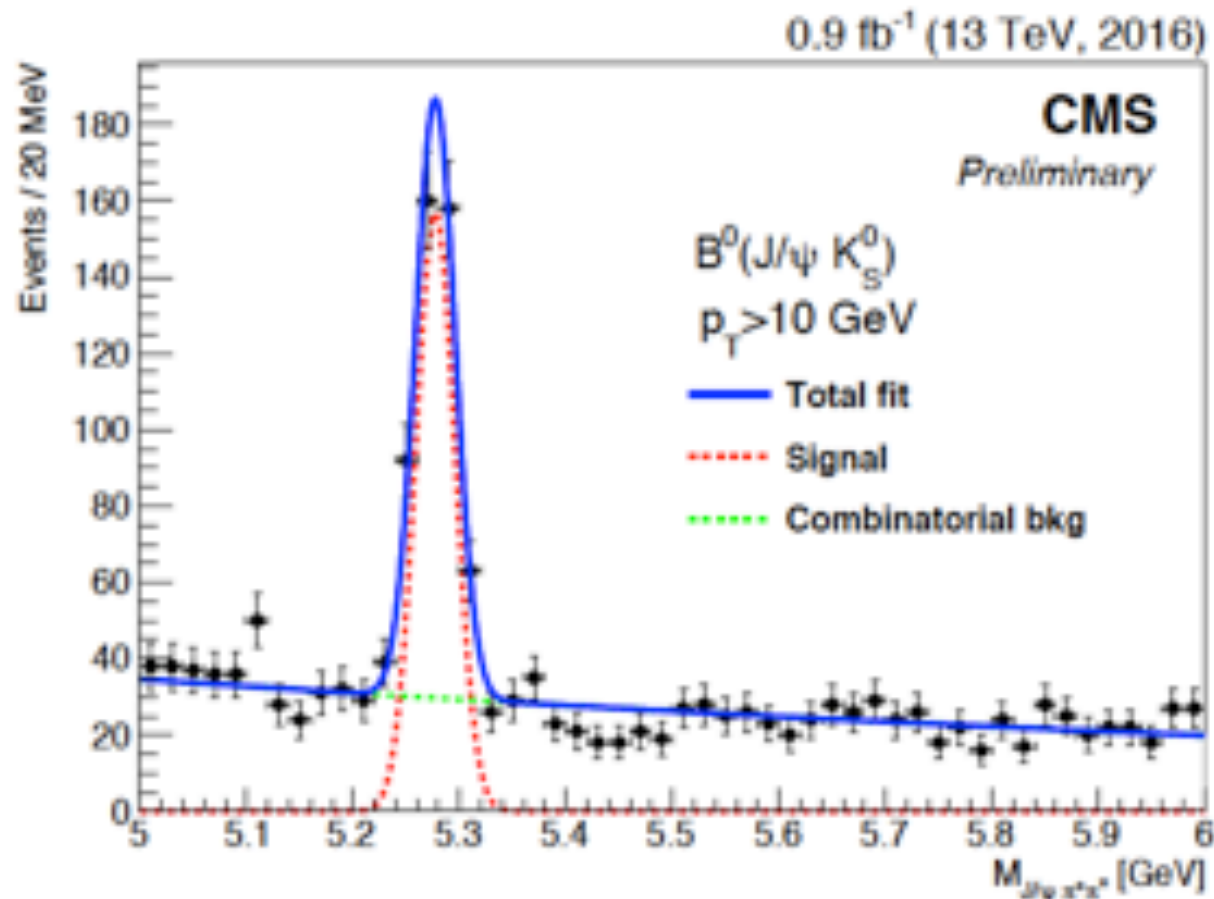

1D (mass [M] fit)

Quality cuts:

$$\cos \alpha > 0.99$$

$$l_{xy}/\sigma(l_{xy}) > 3.0$$

Vertex probability > 10%

$$p_T(J/\psi) > 8 \text{ GeV}$$

$$|M(\pi^+\pi^-) - M(K_S^0)| < 10 \text{ MeV}$$

PDF shape:

- Signal: Gaussian
- Combinatorial background: exponential

Mass: 5.277 ± 0.001 (stat) GeV

CMS B Physics Performance

Displaced J/ψ + track trigger

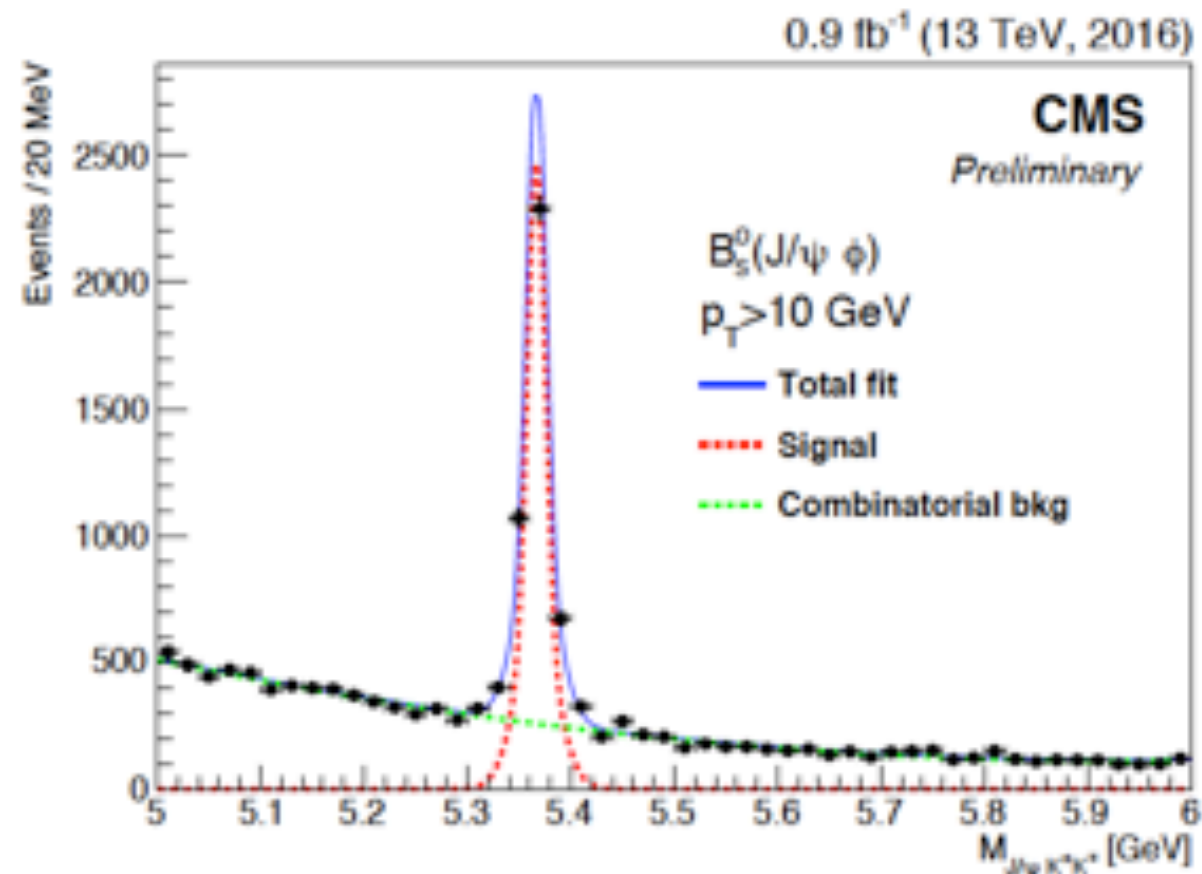

$B_s^0 \rightarrow J/\psi \phi$

1D (mass [M] fit)

Quality cuts:

$$\cos \alpha > 0.99$$

$$l_{xy}/\sigma(l_{xy}) > 3.0$$

Vertex probability > 10%

$$p_T(J/\psi) > 8 \text{ GeV}$$

$$|M(K^+K^-) - M(\phi)| < 10 \text{ MeV}$$

PDF shape:

- Signal: double Gaussian
- Combinatorial background: 2nd order polynomial

Mass: 5.367 ± 0.001 (stat) GeV

CMS B Physics Performance

Displaced J/ψ + track trigger

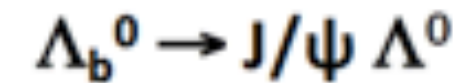
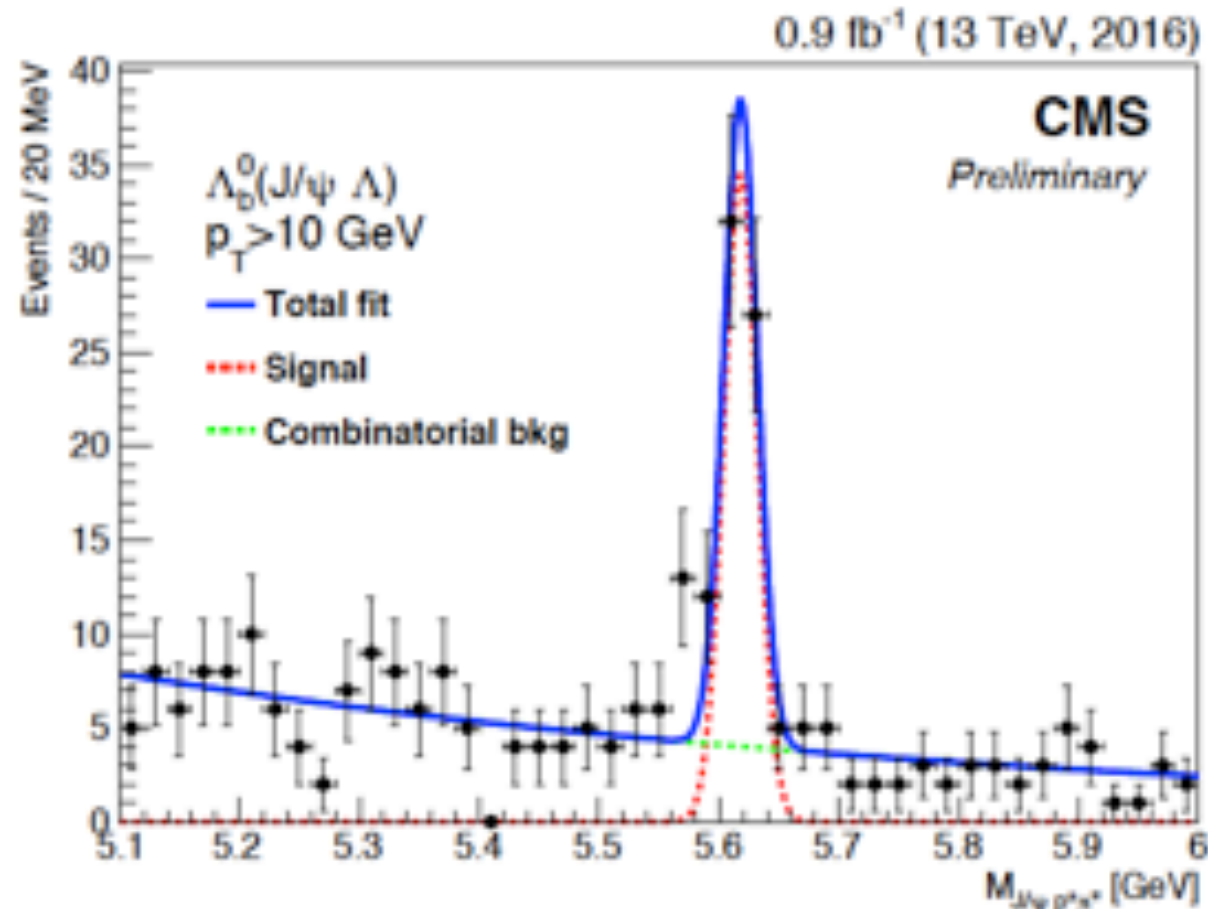

1D (mass [M] fit)

Quality cuts:

$$\cos \alpha > 0.99$$

$$l_{xy}/\sigma(l_{xy}) > 3.0$$

Vertex probability > 10%

$$p_T(J/\psi) > 8 \text{ GeV}$$

$$|M(p\pi^-) - M(\Lambda^0)| < 6 \text{ MeV}$$

PDF shape:

- Signal: Gaussian
- Combinatorial background: exponential

Mass: 5.618 ± 0.002 (stat) GeV

Example : Event Topology of $B^0 \rightarrow J/\psi K\pi$

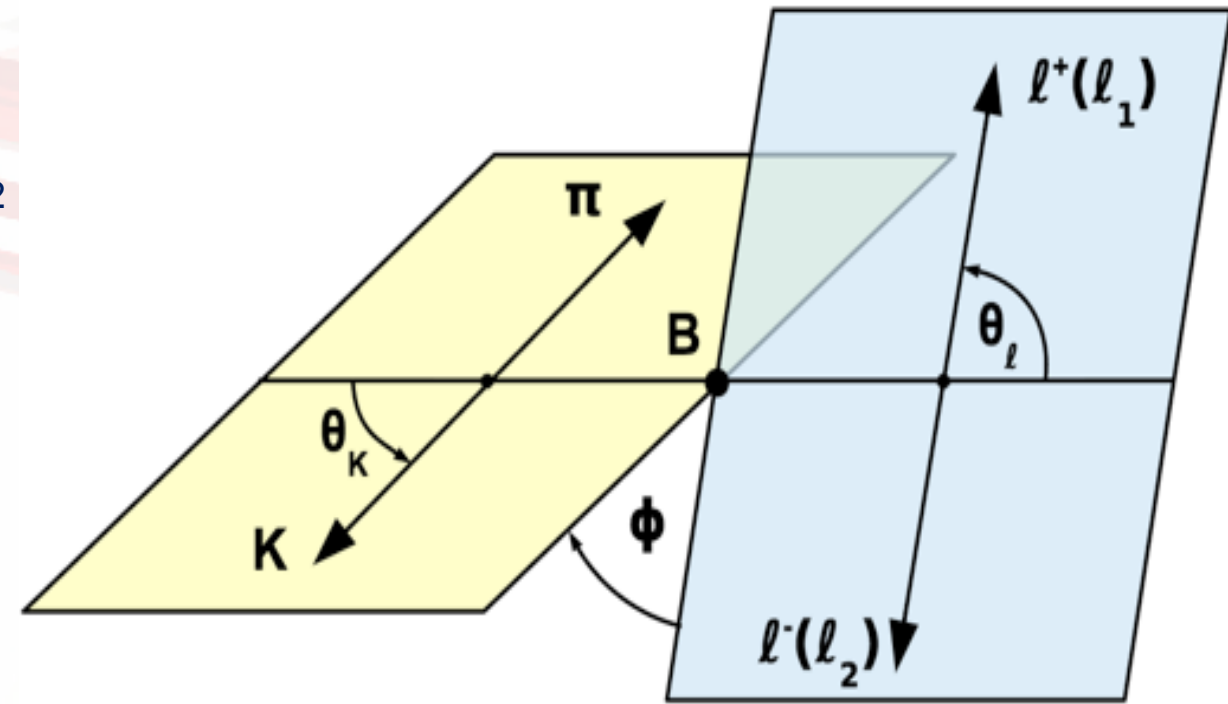
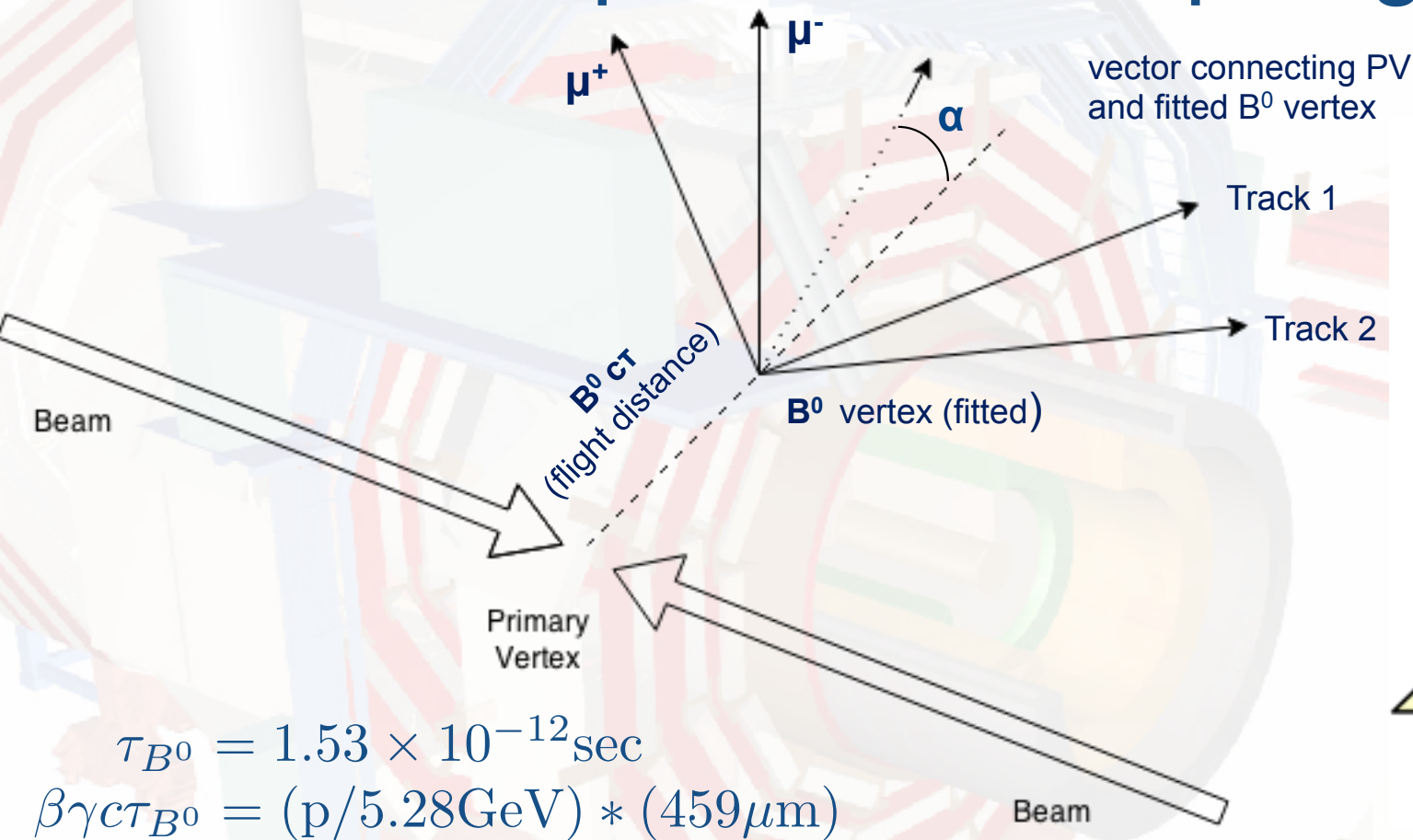

$$\tau_{B^0} = 1.53 \times 10^{-12} \text{sec}$$

$$\beta\gamma c\tau_{B^0} = (p/5.28\text{GeV}) * (459\mu\text{m})$$

- **Muons** : The muons must come from the same vertex (mass constrained kinematic fit), at least 1 muon station well matched to each muon
- **Tracks** : We assign the Kaon mass hypothesis to the B^0 daughter track with lower momentum . This is not optimal but we checked a-posteriori (considering also combinations with swapped mass-hypotheses) that this is the most likely choice
- Reconstruct a B^0 candidate by choosing two (non-overlapping) tracks which come from the same vertex (kinematic vertex fit)
- From Belle result, it can be seen that the decay $B^0 \rightarrow J/\psi K\pi$ cannot be described with $K\pi$ resonances (K^* s) alone. A highly significant $Z(4430) \rightarrow J/\psi \pi$ is also required \rightarrow Amplitude Analysis (discussed later)

Summary

- CMS is capable of and already pursuing an extensive B-physics program. The main areas of ongoing work include
 - Production of quarkonia and heavy flavor
 - Spectroscopy - search for exotic quarkonia
 - Angular analysis and CP violation studies in B decays
 - Precision measurement of B hadrons
 - Rare decay measurements
- Efficiency of generating Monte Carlo events for such studies is very low and hence computationally intensive, which is one of the major bottle-necks
- B Physics performance is strongly dependent on allocated trigger rate which is especially challenging in the high luminosity scenario
- Concentrated effort on B-physics trigger studies has already started and new strategies are being adopted to continue doing B Physics in the coming years
- Watch out for exciting results from CMS ! 