

**Department of High Energy Physics Talk
TIFR, Mumbai**

One Ring to Bring them All



Charged Particle Identification at Belle II

**Saurabh Sandilya
University of Cincinnati
Dec 13, 2017**

Contents

- Why Particle Identification?
- Belle II and SuperKEKB
- Particle Identification in the forward region of Belle II: ARICH
- Particle Identification in the central region of Belle II: TOP
- Expected performance of PID, estimated from MC

Why Particle Identification?

Example 1 : B-factory

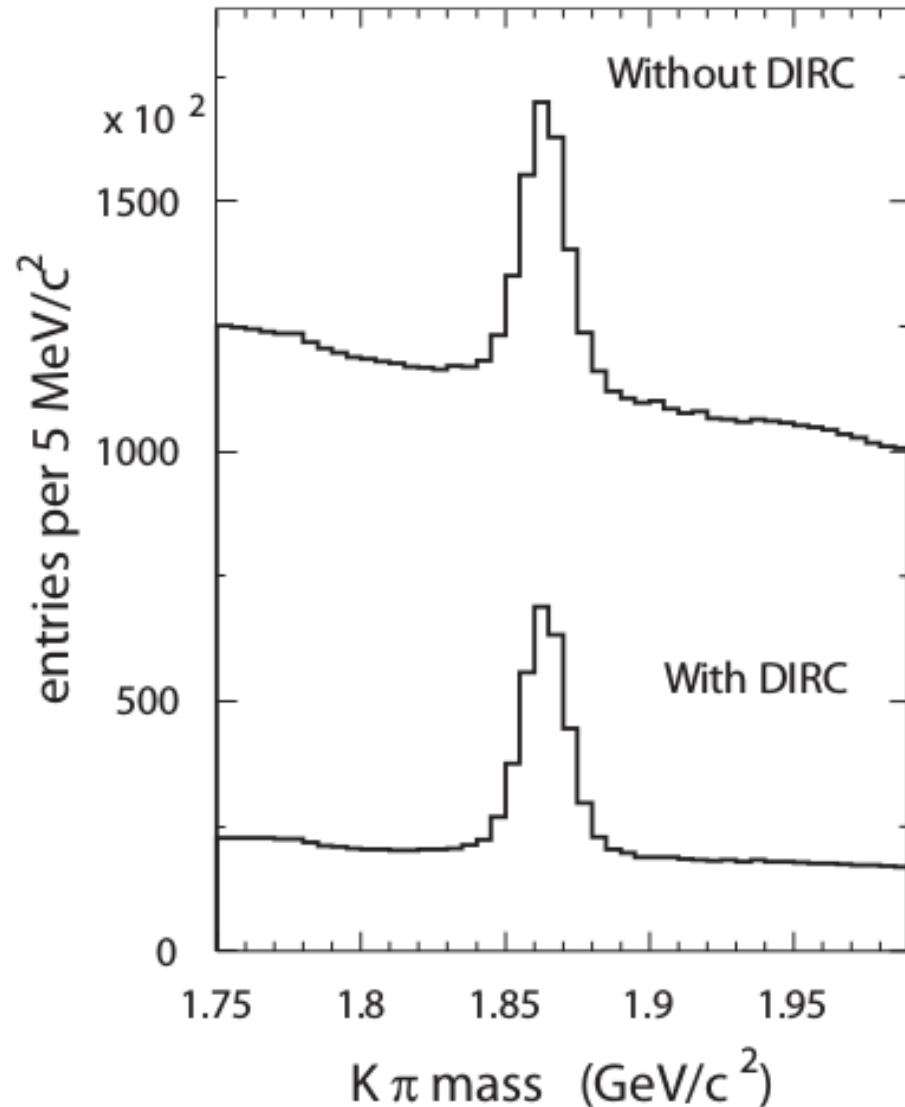

Searching for a D meson decays to $K\pi$:
From measured kaon and pion tracks, the invariant mass of the $K\pi$ system ($i=K,\pi$) is calculated:

$$Mc^2 = \sqrt{\left(\sum_i E_i\right)^2 + \left(\sum_i \vec{p}_i\right)^2 c^2}$$

The candidates for the $D \rightarrow K\pi$ decay show up as a peak in the invariant mass distribution on a background of false combinations (“combinatorial”).

Here, Particle identification requirements reduces the fraction of wrong $K\pi$ combinations (combinatorial background) by $\sim 5x$

Why Particle Identification?

Example 2 : LHCb

- Searching for a Φ meson decays to K^+K^- :

Invariant mass distribution of K^+K^-

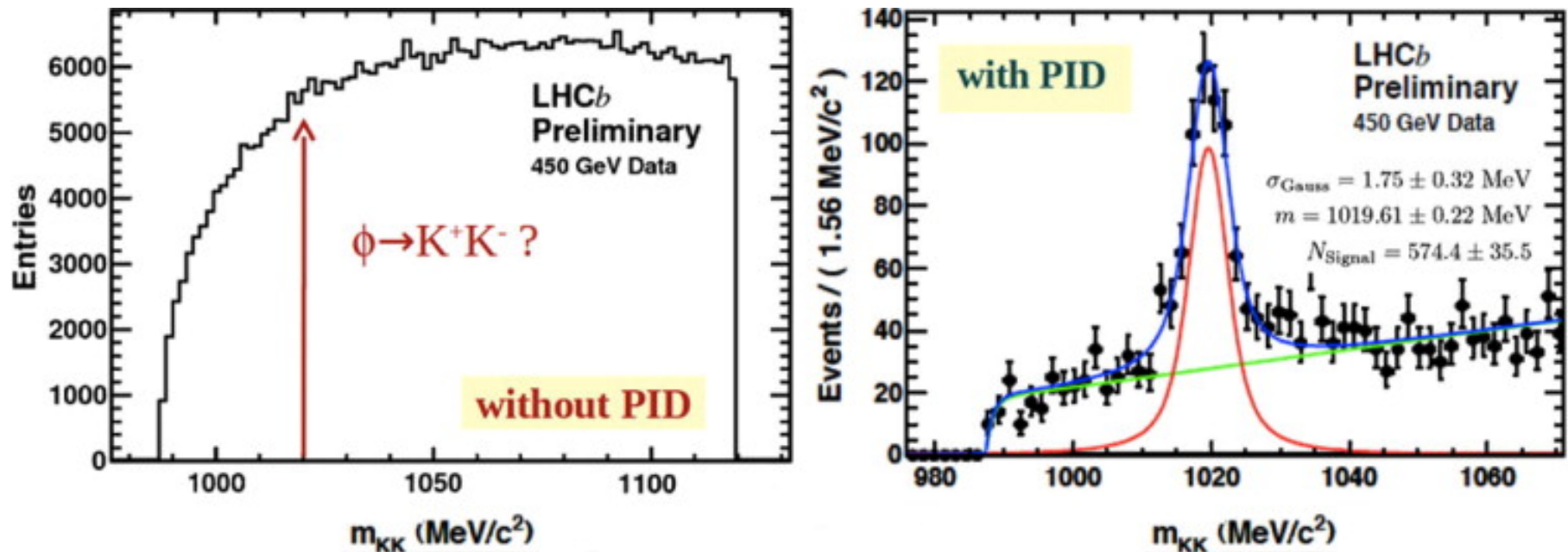

- The decay $\Phi \rightarrow K^+K^-$ only becomes visible after particle identification is taken into account

Particle Identification requirement & method

- A reliable PID is essential for any high energy physics experiment and crucial for the success of B factories.
 - Required for tagging B-meson flavor and precision measurement of rare B/D decays.
 - SuperKEKB will deliver 40 times higher event rates than KEKB at instantaneous luminosity as high as $8 \times 10^{35} \text{ cm}^{-2}\text{s}^{-1}$.
 - To cope up with higher rates and stringent requirements for rare decay channels, more efficient PID is needed.
-
- Particles are identified by their mass or by the way they interact.
 - Determination of mass: from the relation between momentum and velocity, $p = \gamma m v$ (p is known - radius of curvature in magnetic field) → Central Drift Chamber
 - Measure velocity by:
 - Ionisation losses dE/dx → Central Drift Chamber
 - Time of Flight → included in TOP measurement
 - Cherenkov photon angle → TOP and ARICH

Belle II Detector

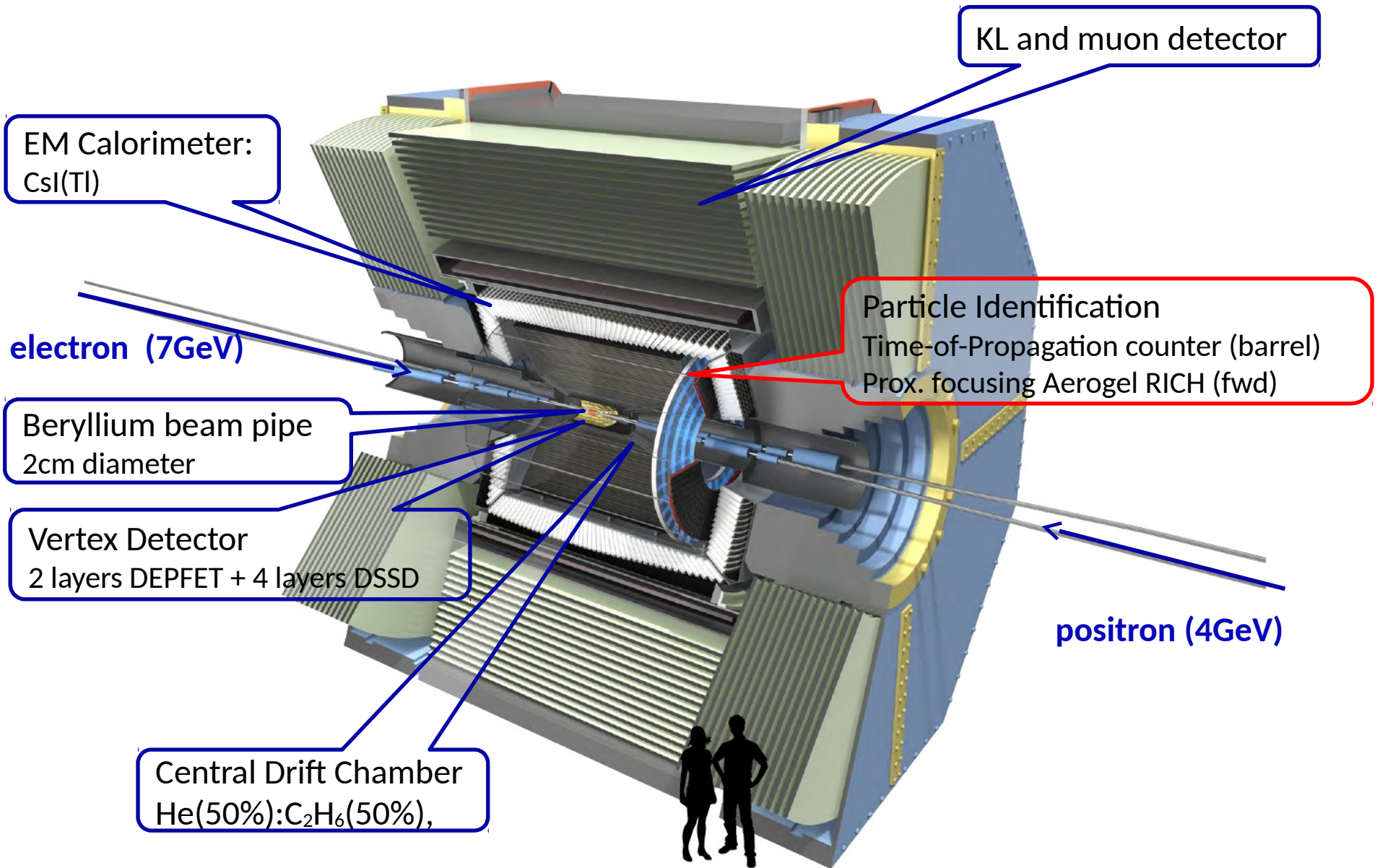

“One ring to bring them all”

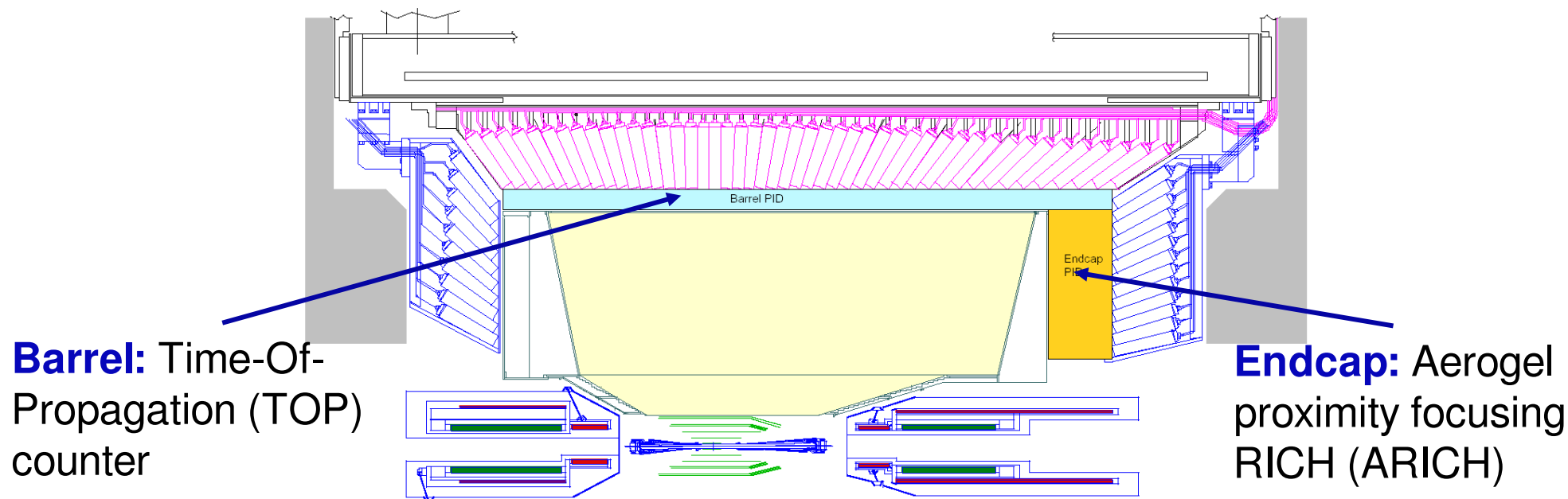

In both region, PIDs at Belle II are ring imaging Cherenkov devices.

A charged track with velocity ($v = \beta c$) exceeding the speed of light (c/n) in a medium (refractive index n) emits Cherenkov light at a characteristic angle,

$$\cos\theta_c = 1/n(\lambda)\beta$$

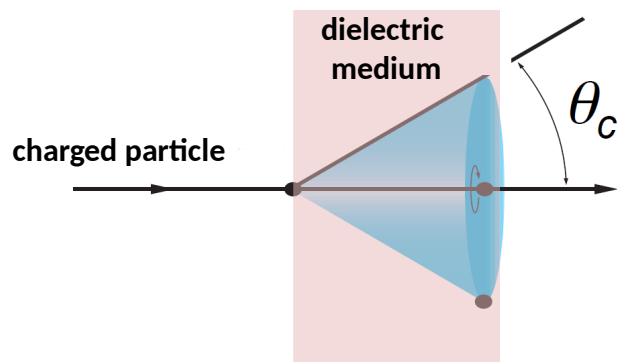

Same momentum pions and kaons will have different velocities (β) and hence the angle of Cherenkov photons.

ARICH detector

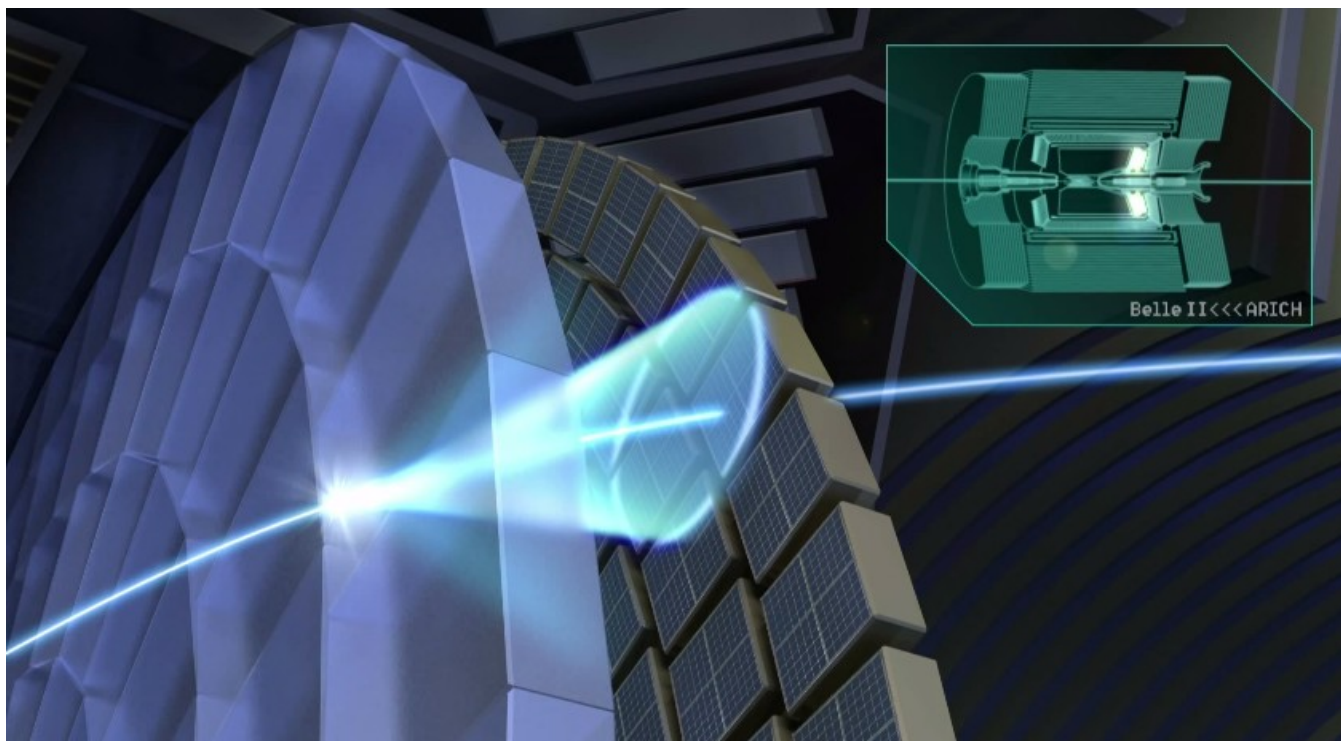

- Provides particle identification system in the front-end endcap region.
- Good separation ($> 4\sigma$) between kaons and pions in the full kinematical region of the experiment ($\sim 0.5 - 4.0$ GeV/c).
- Great importance not only for the reconstruction of decay modes but also for the efficiency of flavor tagging algorithms.

ARICH : principle of operation

- ARICH also relies on the relation between the emission angle of Cherenkov photons and the charged particle velocity,
$$\cos\theta_c = 1/n.\beta \quad (n = \text{refractive index of the radiator})$$
- Aerogel tiles are used as a radiator. Photons, emitted in aerogel, then propagate through ~ 20 cm of an expansion volume and hit the photon detectors (HAPDs).

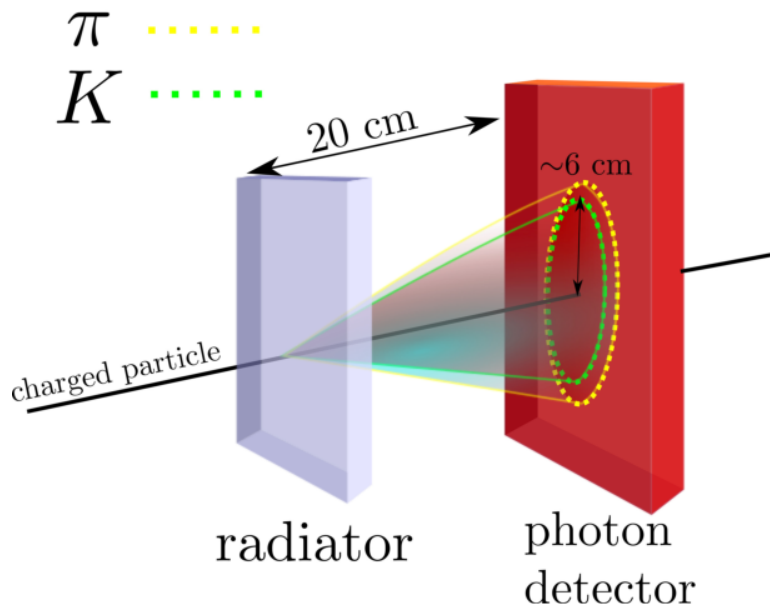

pions and kaons of equal momenta

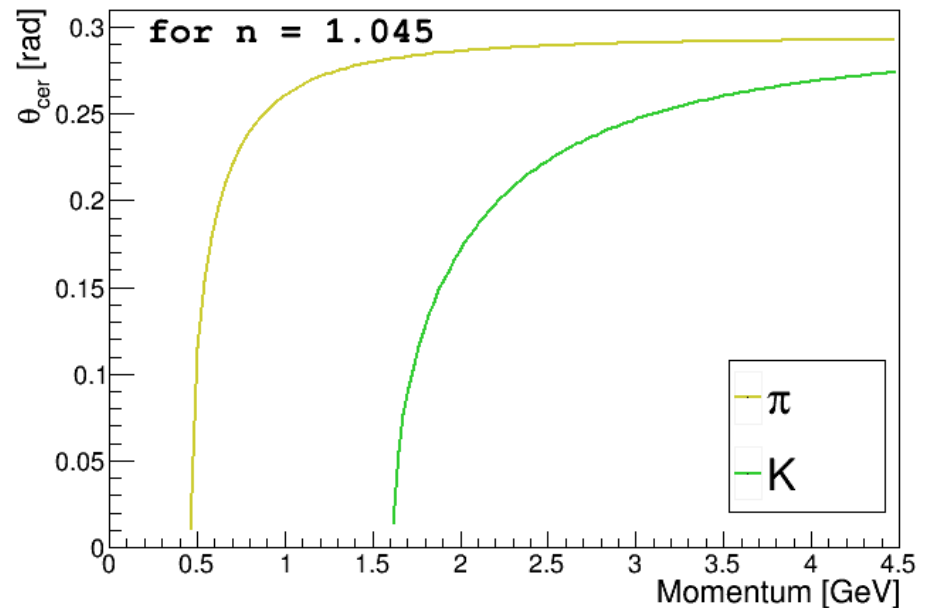

Cherenkov angle vs. particle momentum

- At 3.5 GeV the difference between the pion and kaon Cherenkov angle is ~ 30 mrad.

ARICH detector : principle of operation

- It is desirable to have as thick aerogel layer as possible, as this increases the number of emitted photons, but thicker aerogel also increases the uncertainty in the photon emission point.
- Two aerogel layers with different refraction indices, are chosen so that the two rings, overlap on the detector plane.

$$\frac{dN}{dE} \propto L \sin^2 \theta_c$$

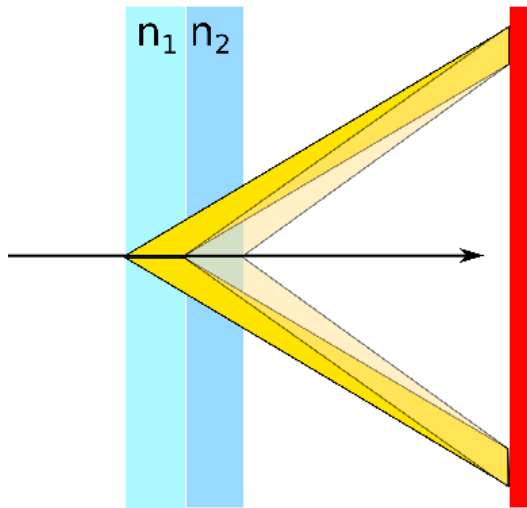

- Refractive index $n_1 = 1.045$ and $n_2 = 1.055$

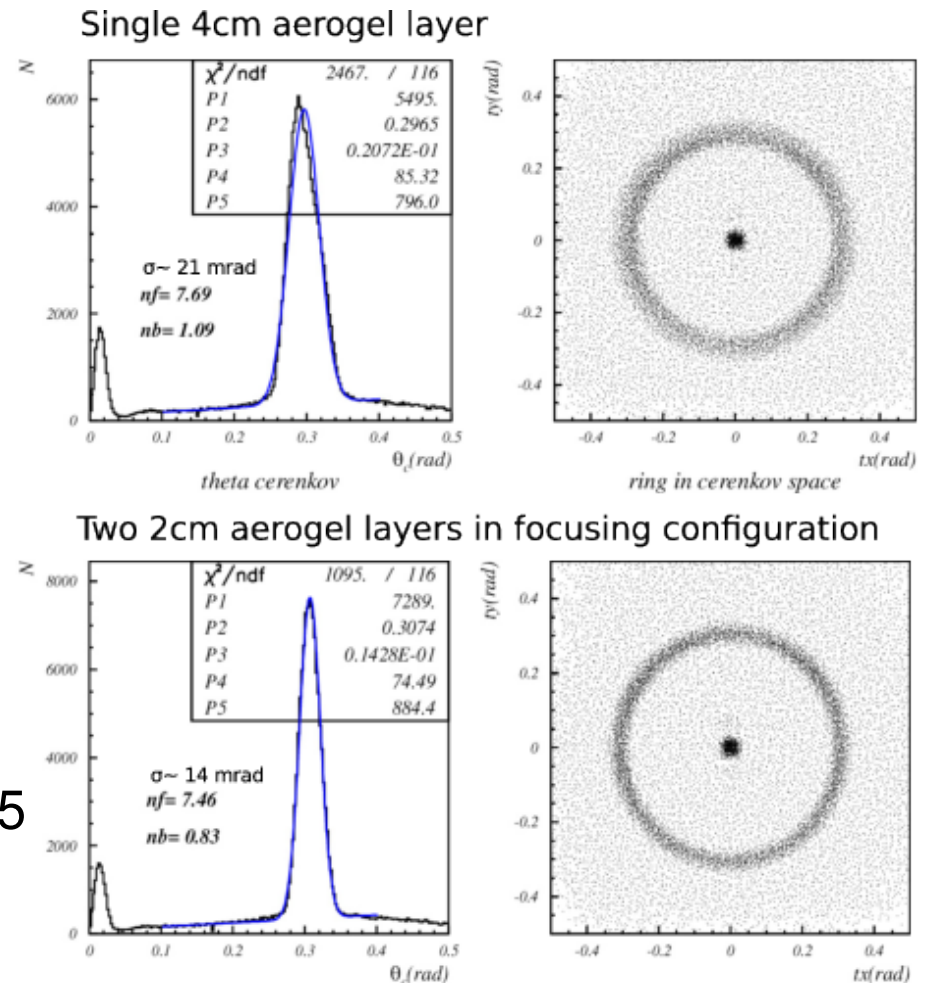

ARICH : principle of operation

- As a radiator a 'silica aerogel' is used, which is an amorphous, highly porous solid of silicon dioxide (SiO_2).
- Tunable (intermediate) refractive index and good optical transparency. Refractive index depends on the silica-air volume ratio (typically 1:9)
- 3.5 m^2 radiator plane is covered by two layers of wedge-shaped aerogel tiles of size $(17 \times 17 \times 2) \text{ cm}^2$.

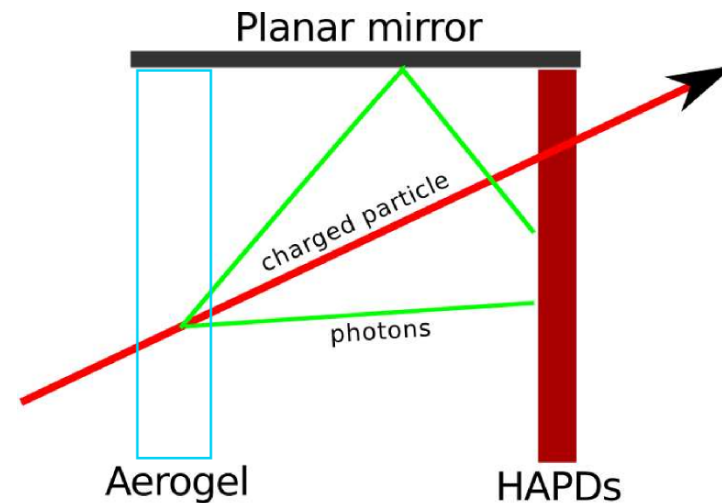
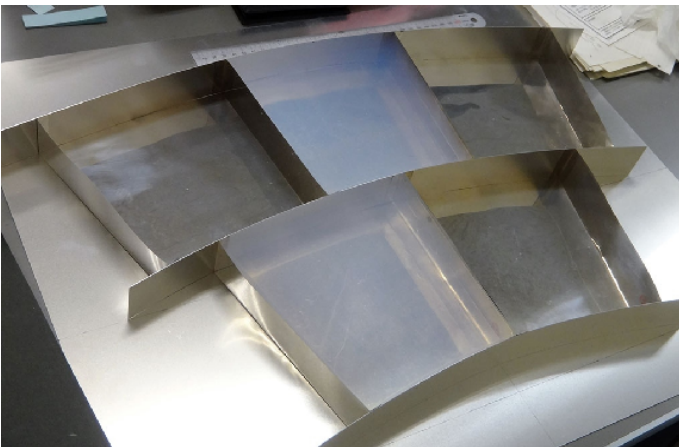
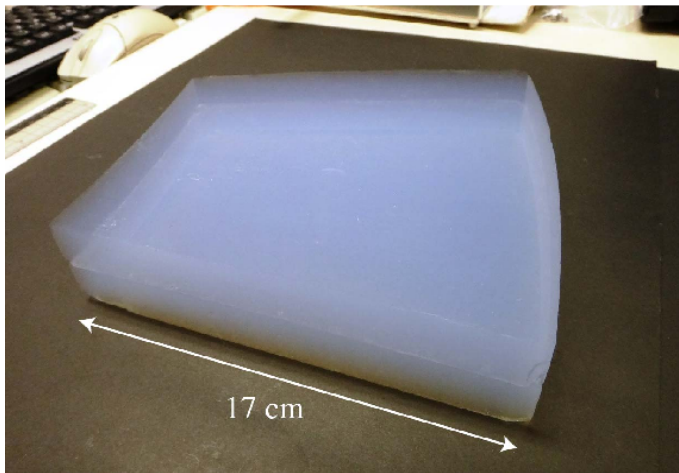

- To maintain good performance on the outer edge of the detector, where Cherenkov photons would miss the photo-sensitive area, 18 planar mirror plates are placed.

ARICH : HAPD (Photon Detector)

Requirements:

- sensitive to single-photons
- provide two-dimensional position information
~5mm pixel.
- should be immune to 1.5T Magnetic field
- tolerant to the high radiation environment
(1000Gy for γ and 10^{12}cm^2 for neutron in 10yrs)

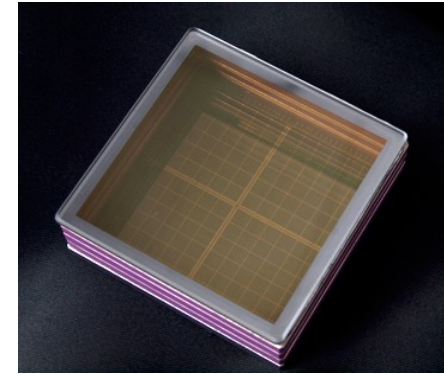

Hybrid Avalanche Photo-Detector

HAPD Working Principle

- Incident photon is converted into photo-electron by a bi-alkali photo-cathode (peak quantum efficiency of ~30% at 400 nm.)
- electron accelerates in high electric field towards the segmented avalanche photo-diode (144 pads of size 4.9×4.9 mm) ~ 300V reverse bias voltage
- Avalanche gain ~40, bombardment gain ~1800.
- Detection of a single photon results in an avalanche of about 70,000 electron.

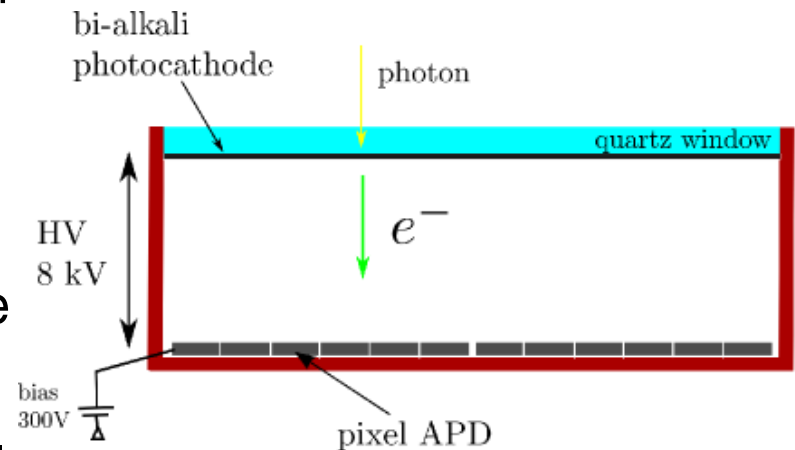

ARICH : Geometry

photon detector plane sextant

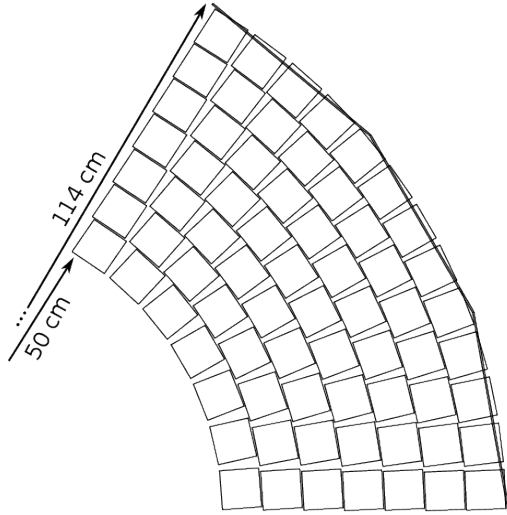

aerogel plane sextant

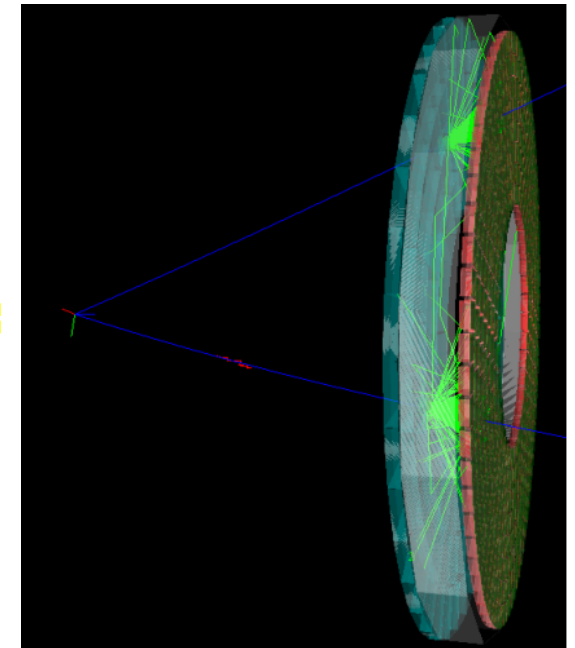
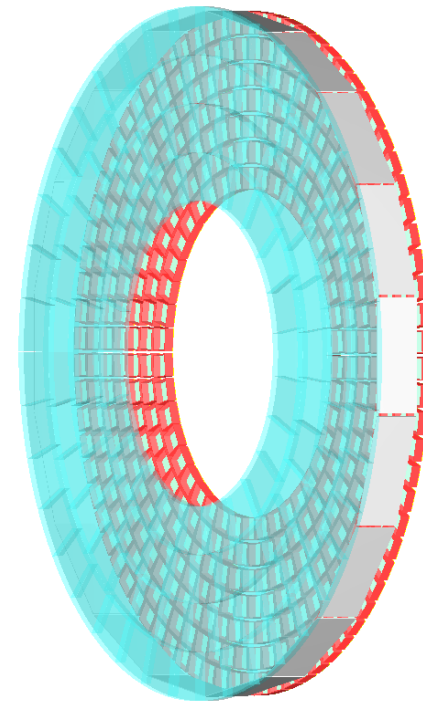
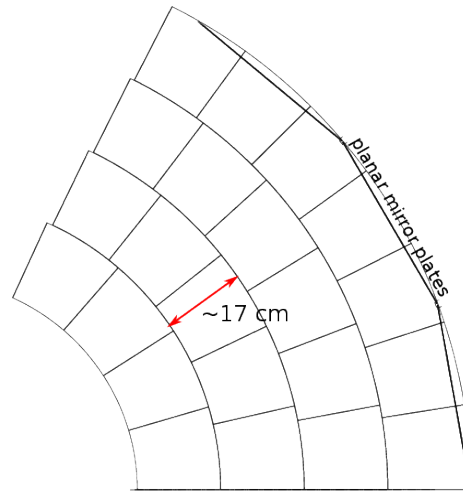

- 420 HAPD modules are arranged in 7 concentric rings.
- 2 × 124 aerogel tiles
- 18 planar mirror plates on the outer edge

2 pion tracks with 3.5 GeV hitting ARICH

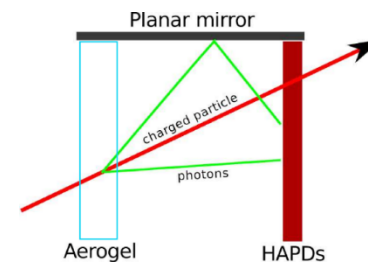

ARICH : Beam Test

- Prototype of ARICH is constructed, with two consecutive aerogel tiles and six HAPD modules, arranged as in a part of actual detector layout → at DESY 4-5 GeV/c electron beam (2013)

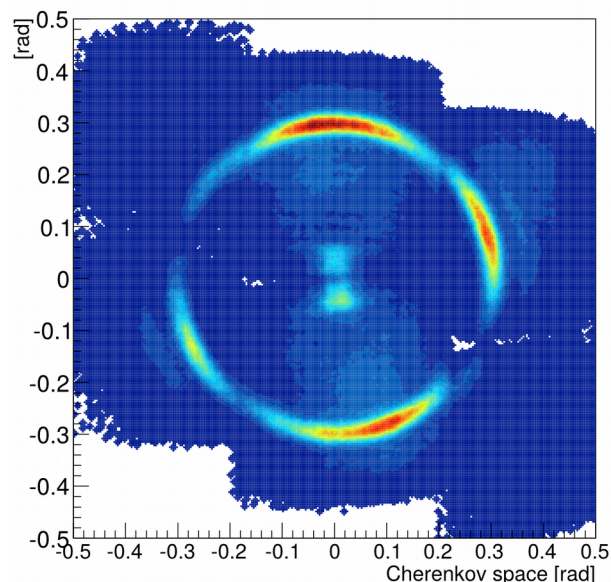
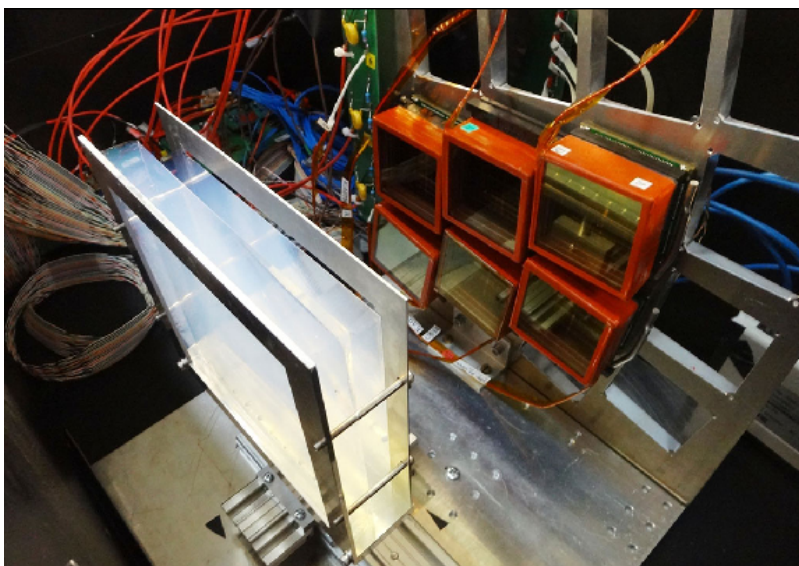

← accumulated distribution of reconstructed Cherenkov angle

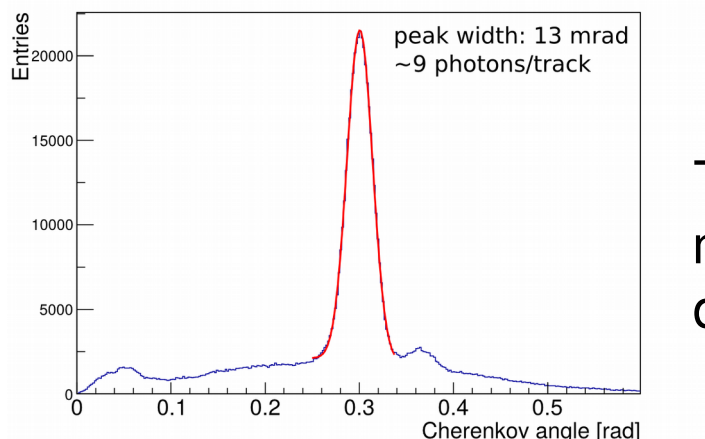

The single photon angle resolution is about 13 mrad and on average 9 photons per track are detected.

ARICH : Beam Test

- Prototype of ARICH is constructed, with two consecutive aerogel tiles and six HAPD modules, arranged as in a part of actual detector layout → at DESY 4-5 GeV/c electron beam (2013)



[rad] 0.5
0.0
-0.5
First Cosmic event seen by ARICH!

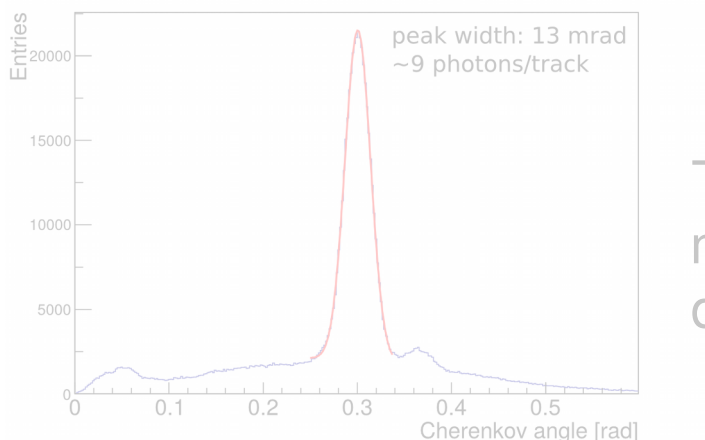

ARICH : current status

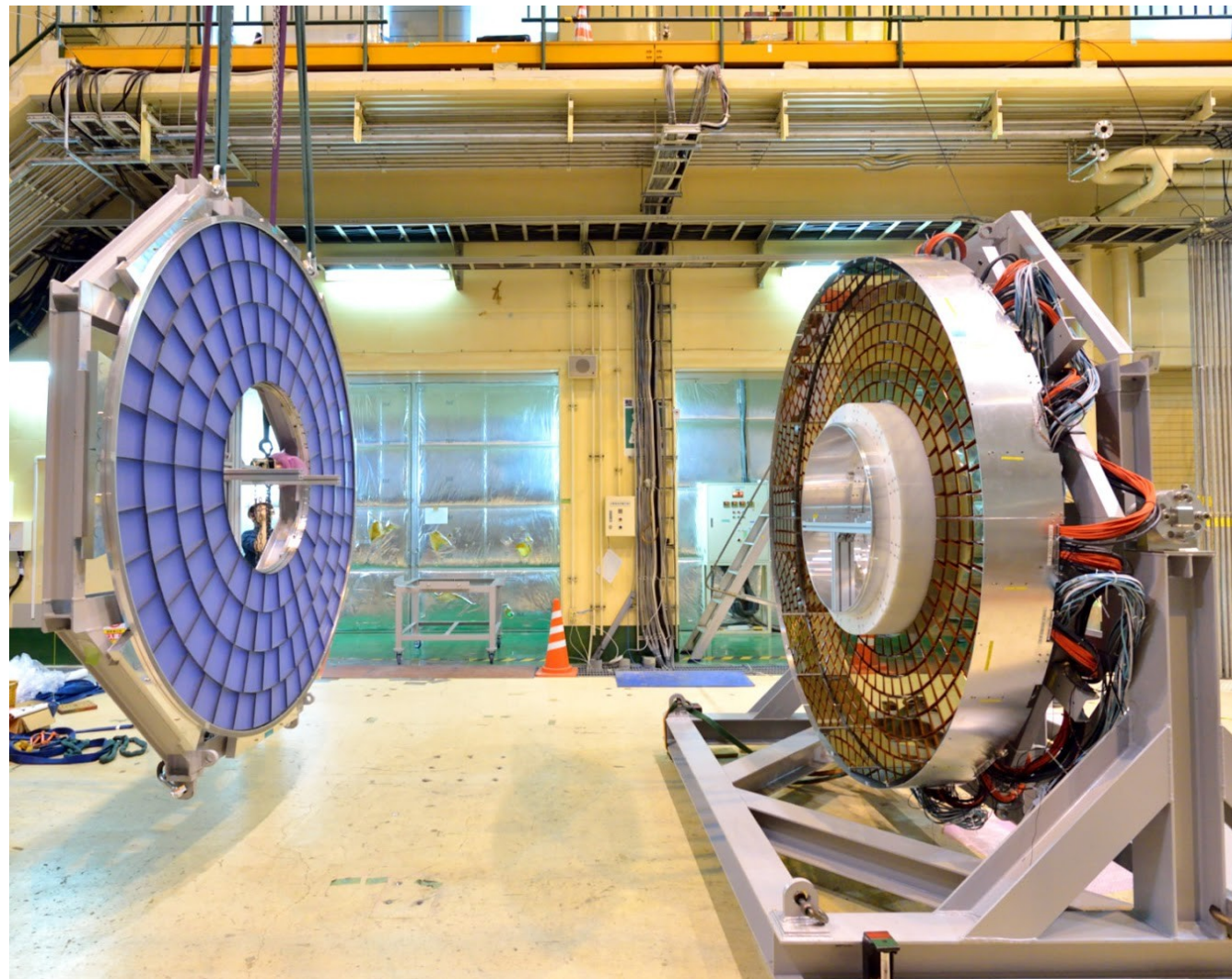
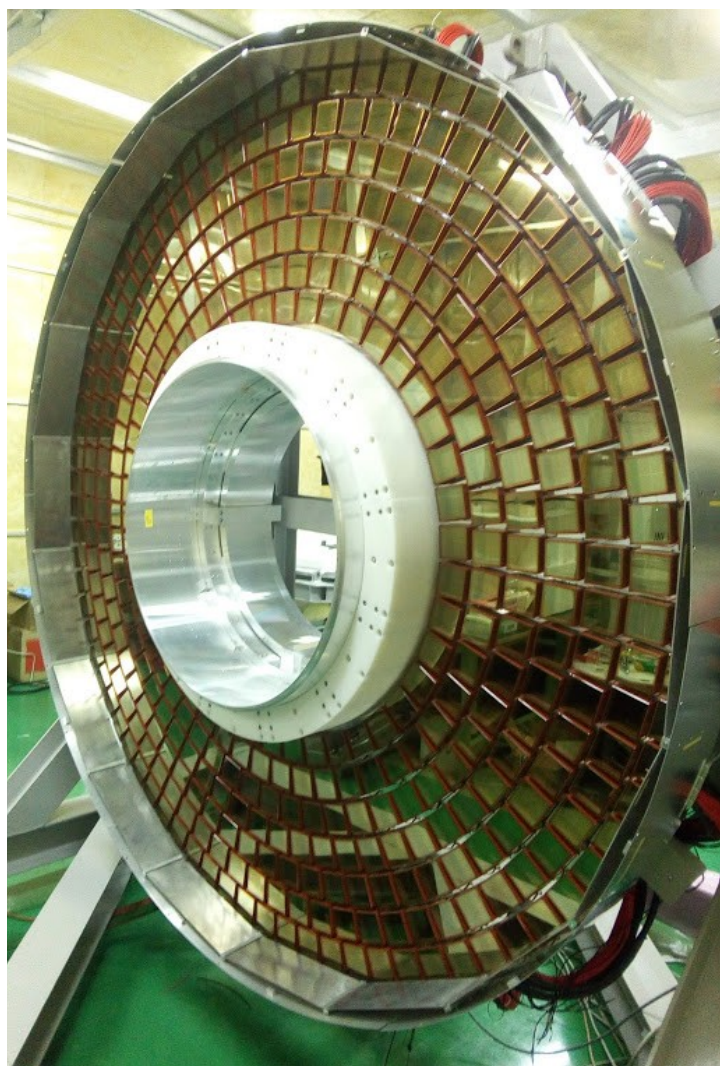

ARICH : current status



ARICH is now installed to the Belle II detector

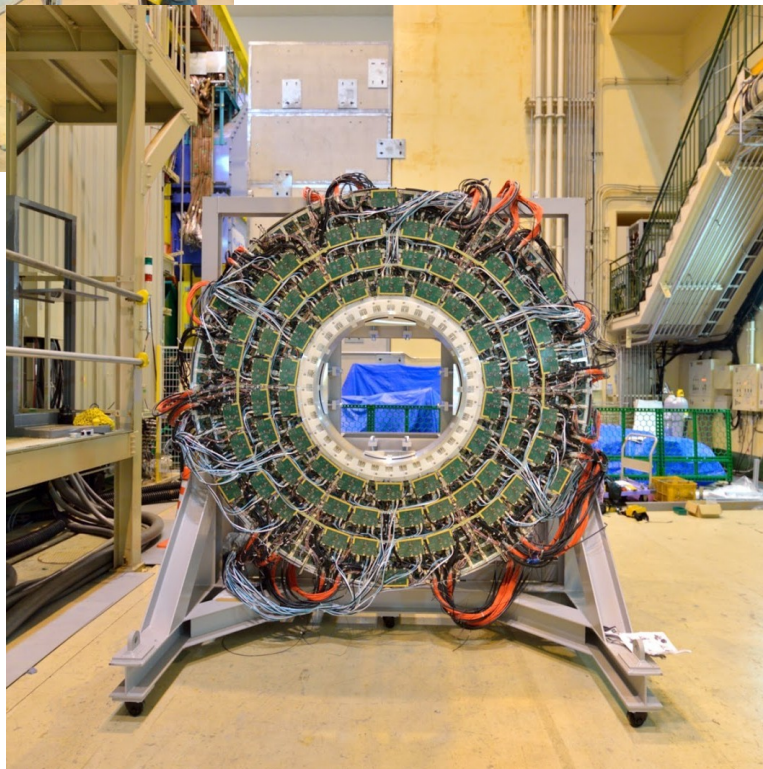

TOP : Introduction

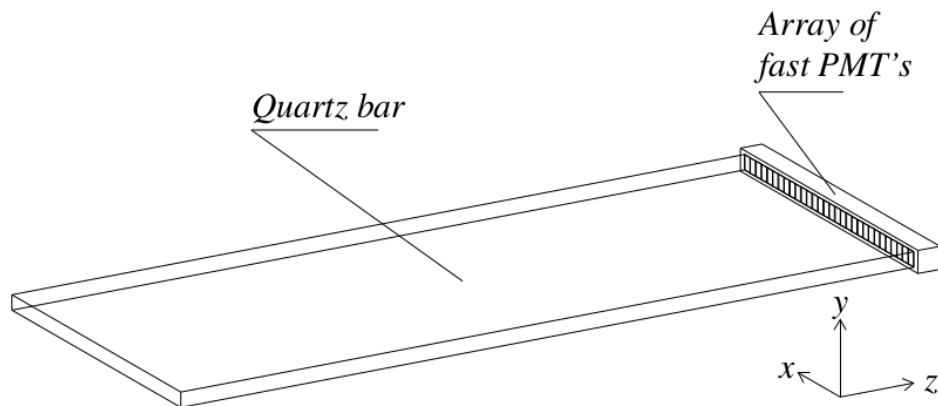
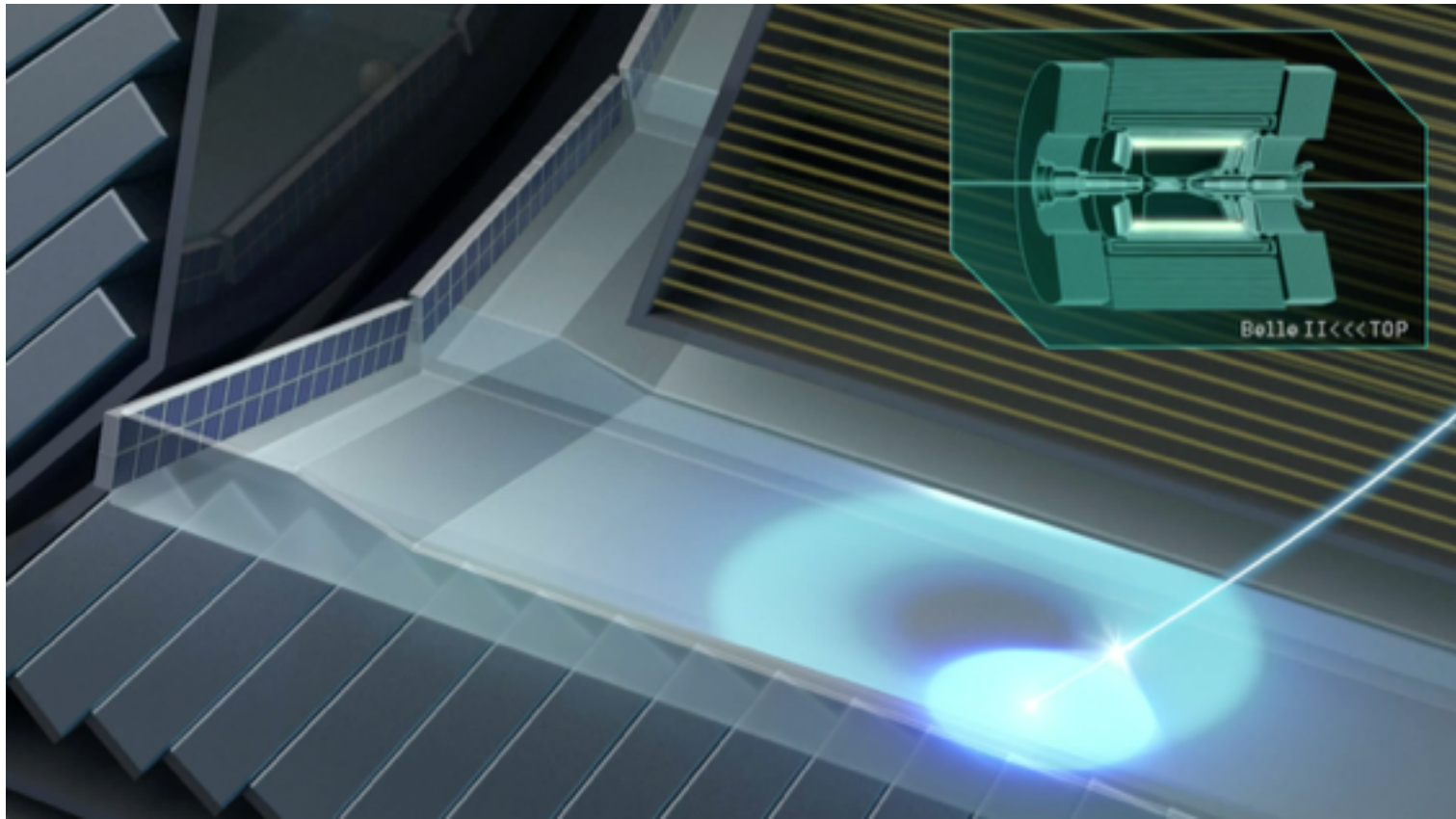

TOP : Working Principle

Cherenkov photons emitted in the quartz radiator from the charged track \rightarrow total internal reflection \rightarrow registered at the end of the bar by a fast position sensitive detector of single photons.

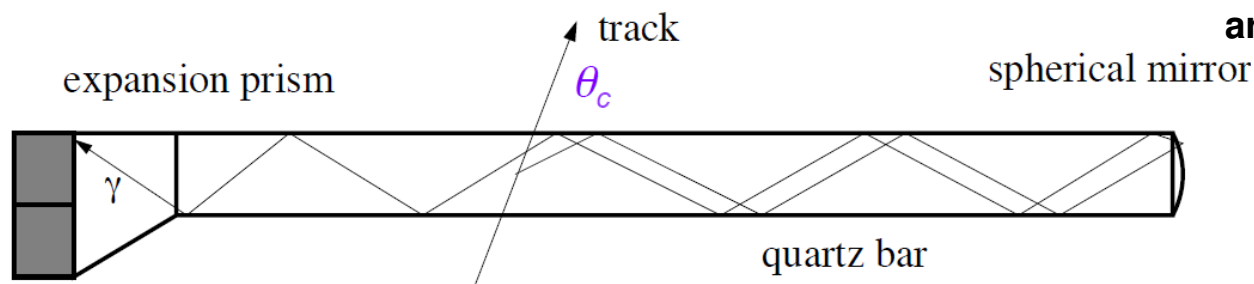

K/ π different $\theta_c \rightarrow$ different path length \rightarrow different time of propagation.

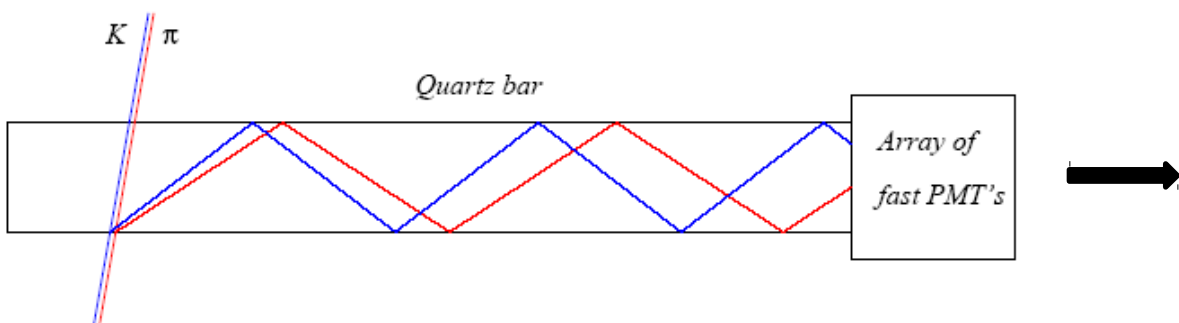

θ_c is reconstructed from: hit position (x,y) in the photo detector plane and time of propagation

Channel Vs. time for 3GeV pions/kaons with beam test setup
arrival time of photon vs. position (channel no.)

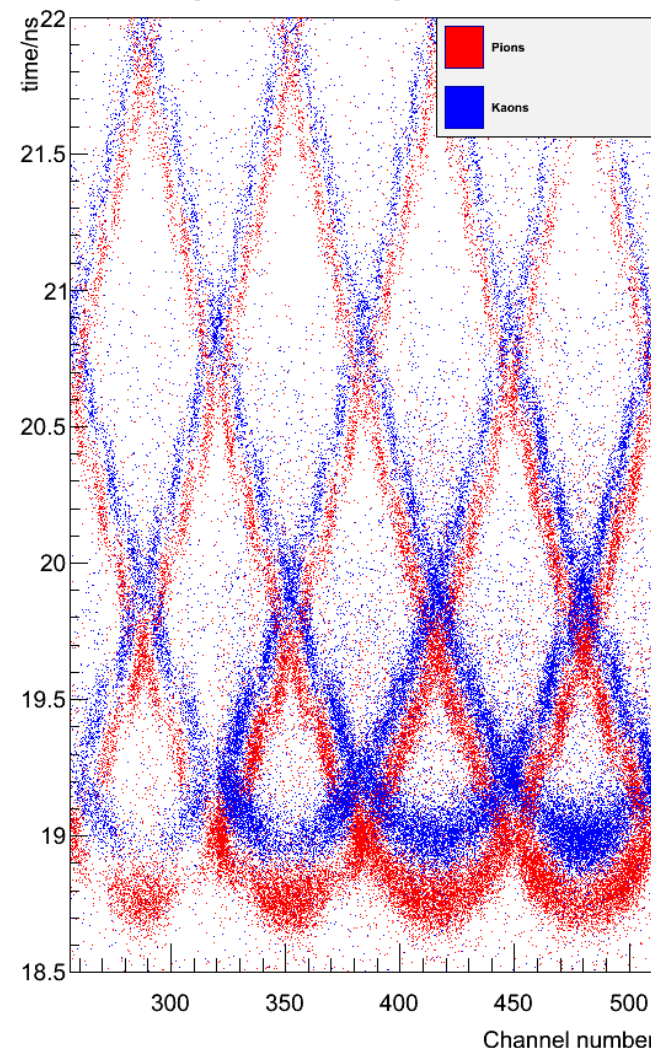

TOP : need of mirror

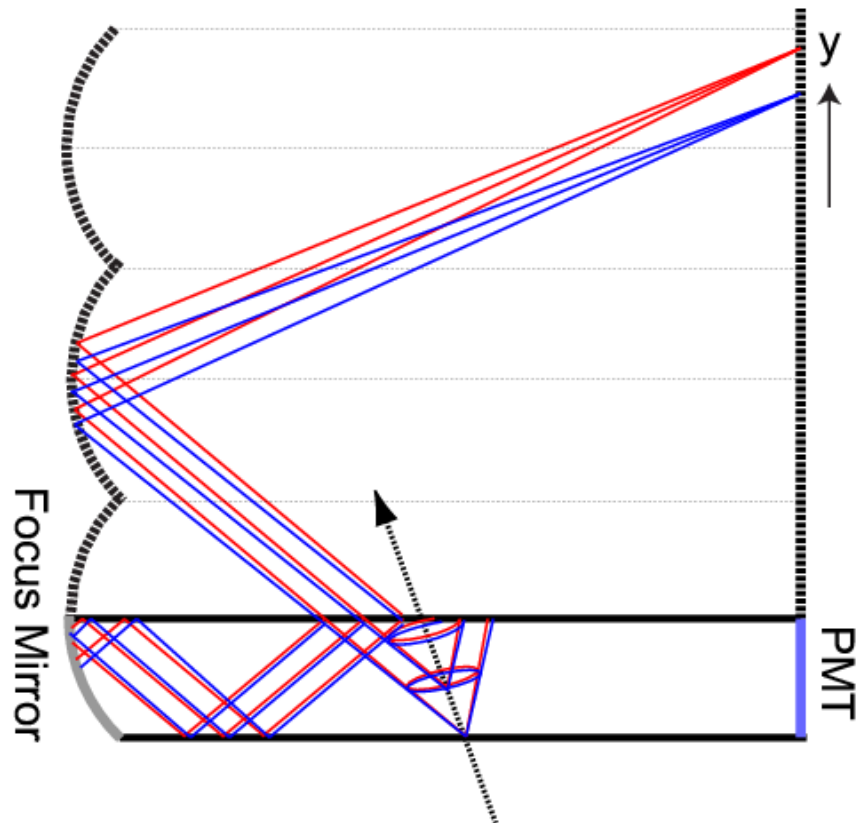

- parallel rays get focused to a single point → removes bar thickness
- non-parallel rays are focused to different points →
 - K/π separation
 -

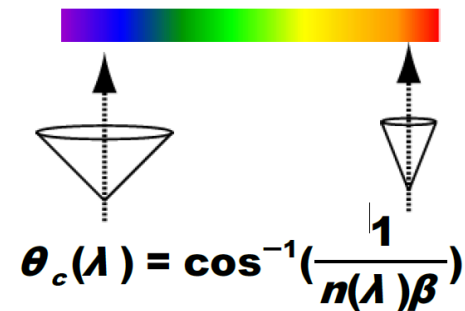

allows to correct for chromatic dispersion.

TOP : Geometry

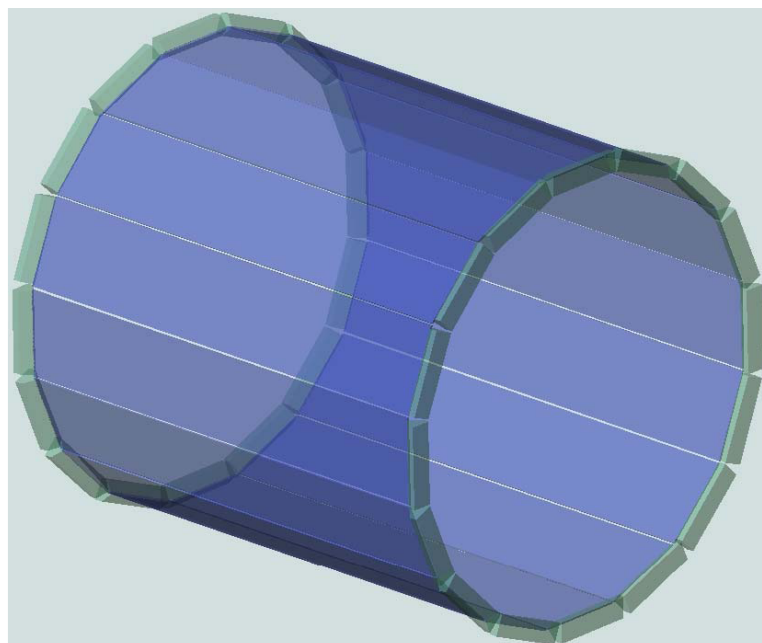
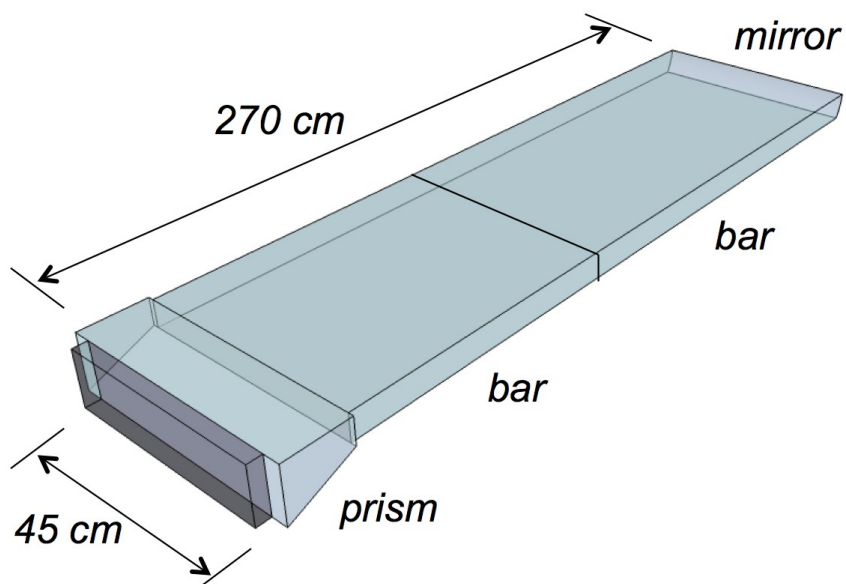

TOP modules consists of:

- Two **fused silica bars**, (each $45 \times 125 \times 2 \text{ cm}^3$) \rightarrow Radiator to generate Cherenkov photons.
- **Mirror** ($45 \times 10 \times 2 \text{ cm}^3$) \rightarrow focus the emitted photons to the sensor plane
- **Prism** ($45.6 \times 10 \times 2 \text{ cm}^3 \rightarrow 45.6 \times 10 \times 5.1 \text{ cm}^3$) to expand the image and improving resolution.
- **MCP-PMT**: At the exit window of the prism, two rows of sixteen fast multi-anode photon detectors (MCP-PMT) are mounted.
- In total **16 TOP modules**, are arranged in a barrel shaped array with inner radius $\sim 1.2 \text{ m}$

TOP : requirements on quartz bars

S1 peak-to-peak: $5.3 \mu\text{m}$ ($< 6.3 \mu\text{m}$)
S2 peak-to-peak: $4.6 \mu\text{m}$ ($< 6.3 \mu\text{m}$)

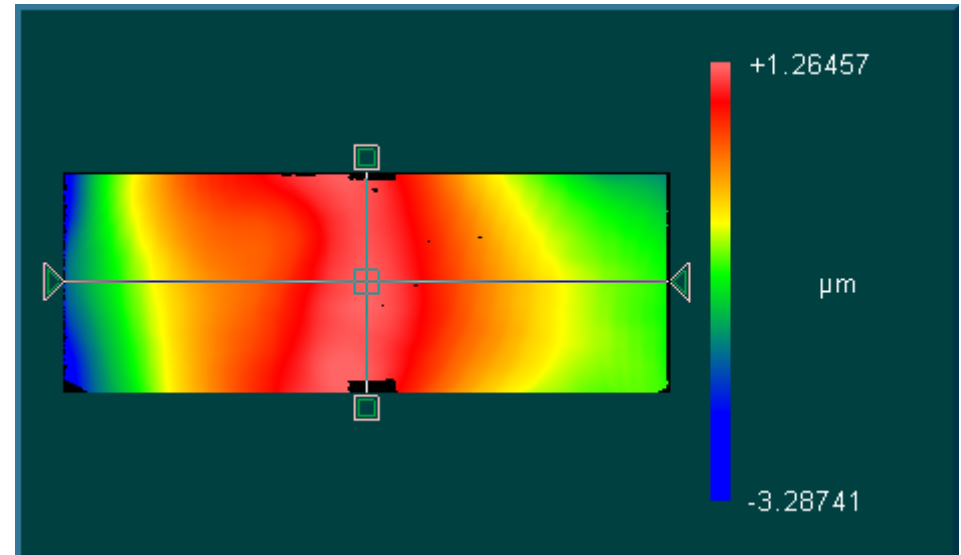
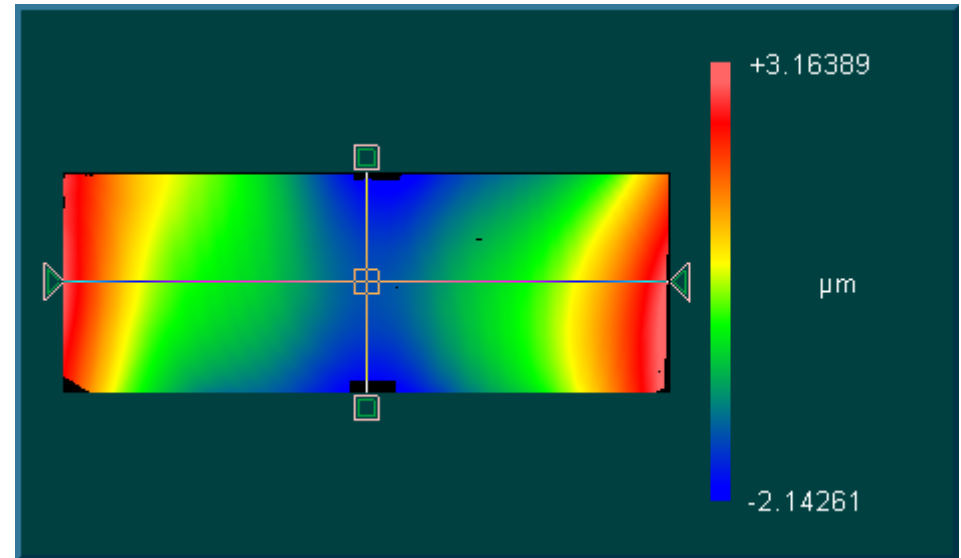
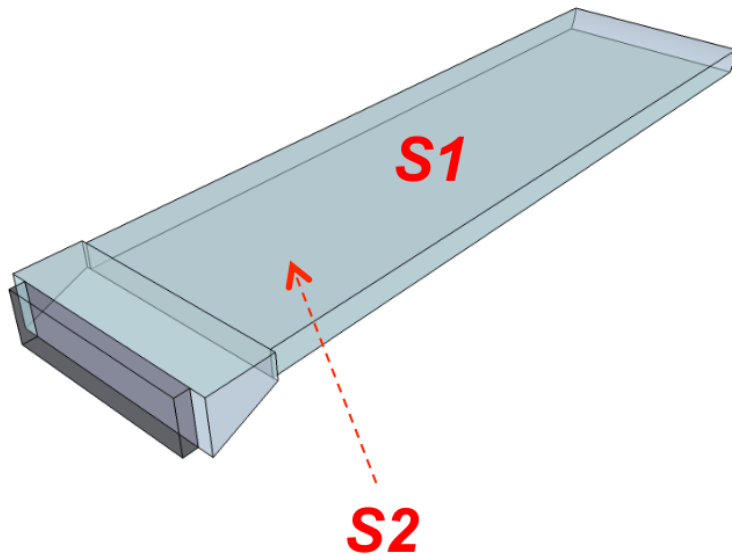

TOP : preparing a module

3 types:

- bar to bar
- bar to prism
- bar to mirror

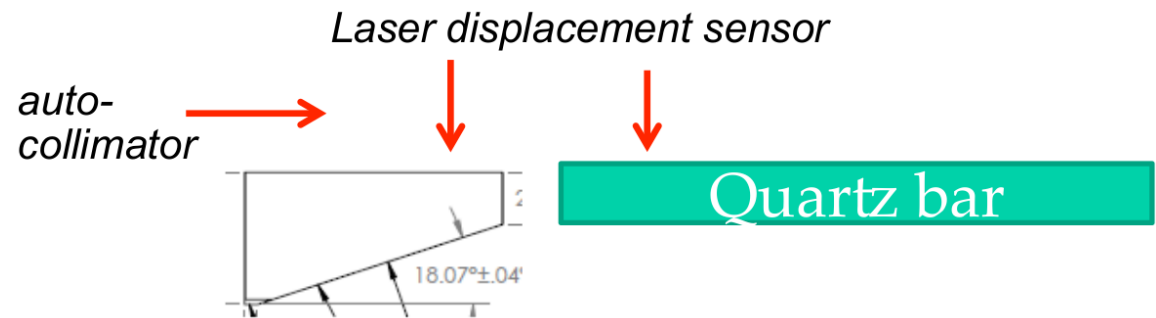

Alignment and Gluing:

- adjust surfaces positions using laser displacement sensor and micrometers
- adjust surfaces angles using autocollimator and micrometers
- insert shims, tape joint and repeat steps 1, 2
- apply epoxy (EPOTEK 301-2) to joint

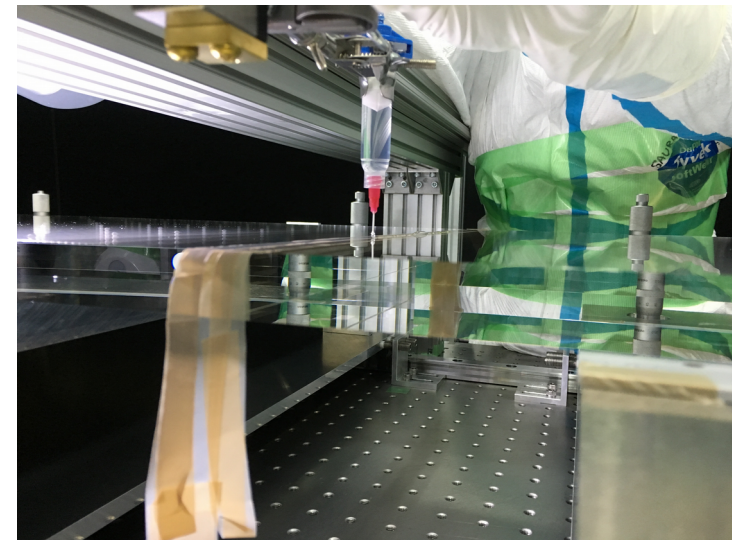
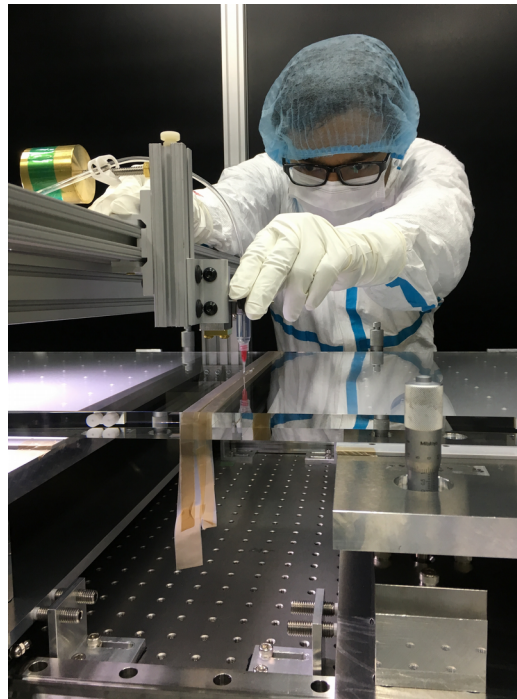
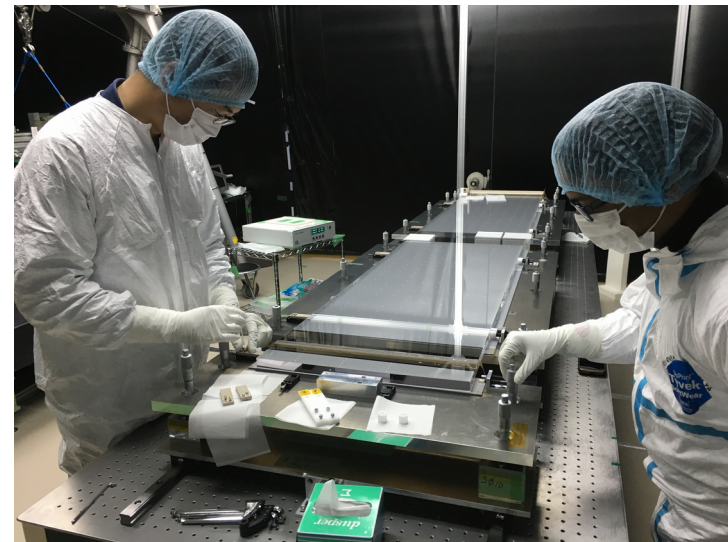

TOP : MCP PMTs

- A micro-channel plate (MCP) photomultiplier tube (PMT) provides a good time response.
- Transit time spread $\sim 30 - 35$ ps (required is < 50 ps)

Characteristics

- Overall size : $27.5 \times 27.5 \times 15.6$ mm³
 - Photo cathode : Multi-alkali (23×23 mm²)
 - MCP width: 400 μ m, pore: 10 μ m and bias angle: 13 degrees
 - Anode 22×22 mm² (divided into 4×4 pads)
 - Dimensions of each pad: 5.275×5.275 mm² with gap 0.3 mm
-
- Quantum efficiency : $> 24\%$ at $350-400$ nm
 - Gain : 2×10^6 at ~ 3 kV
 - Dark-rate : 5 kHz for 16 anodes

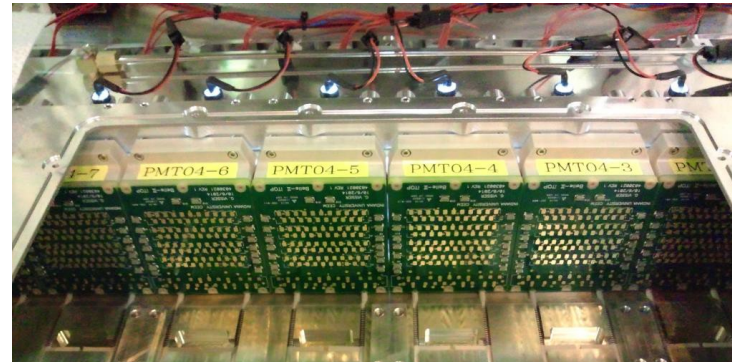
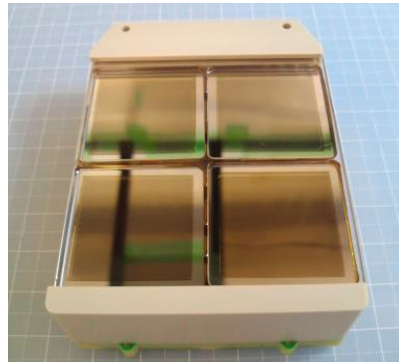
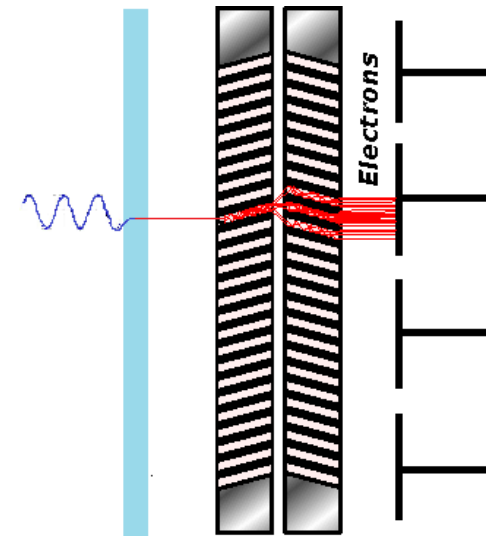

TOP : MCP-PMTs

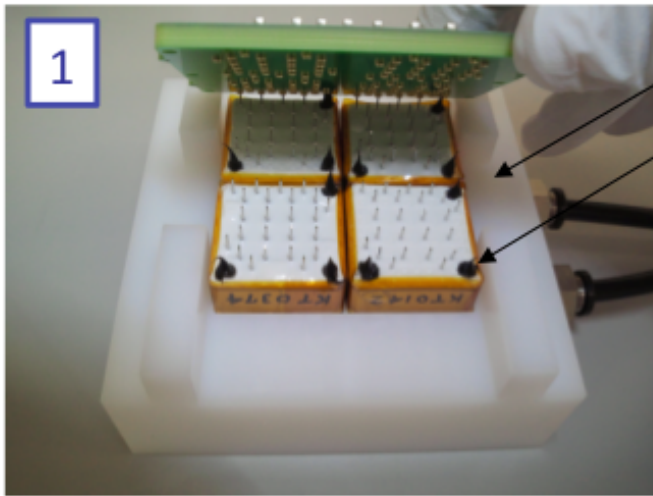

1

Vacuum chuck to align the PMT faces
RTV silicon rubber to hold the PMTs

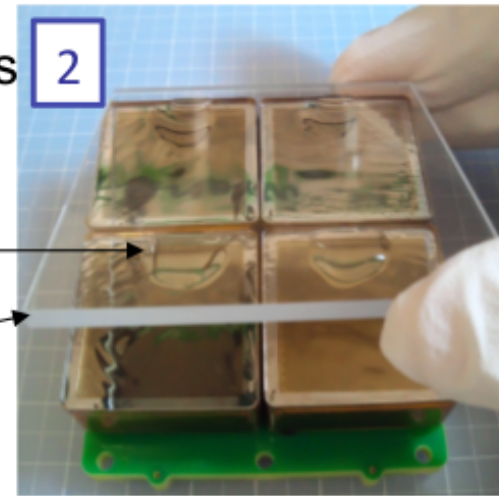

2

Silicon rubber TSE3032 (before curing) to be filled between the PMTs and the wavelength cut filter

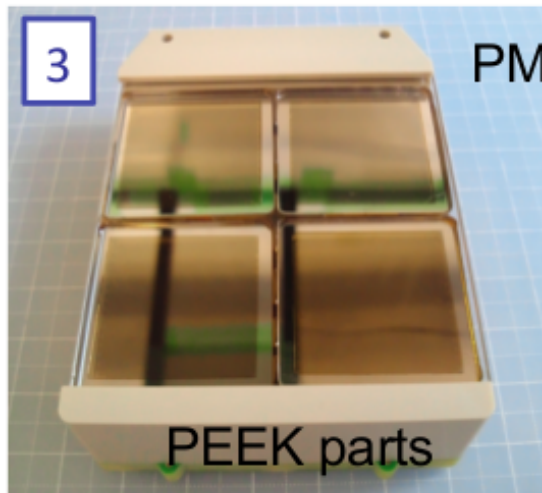

3

PMT module completed

PEEK parts

2 PMT modules mounted to prism with a "cookie" (+oil):

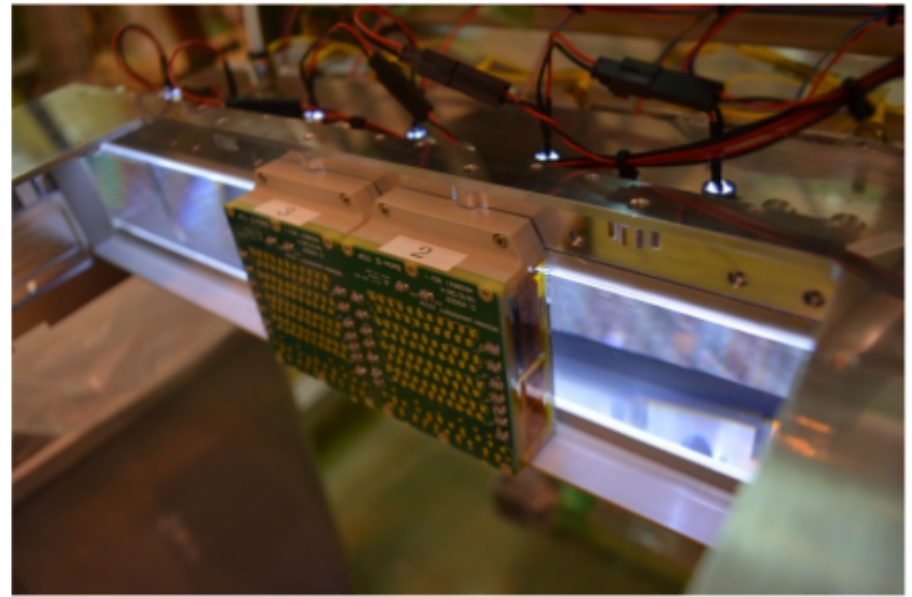

TOP : Beam Test

- Beam test in June 2013 at the LEPS beamline at SPring-8 in Japan.

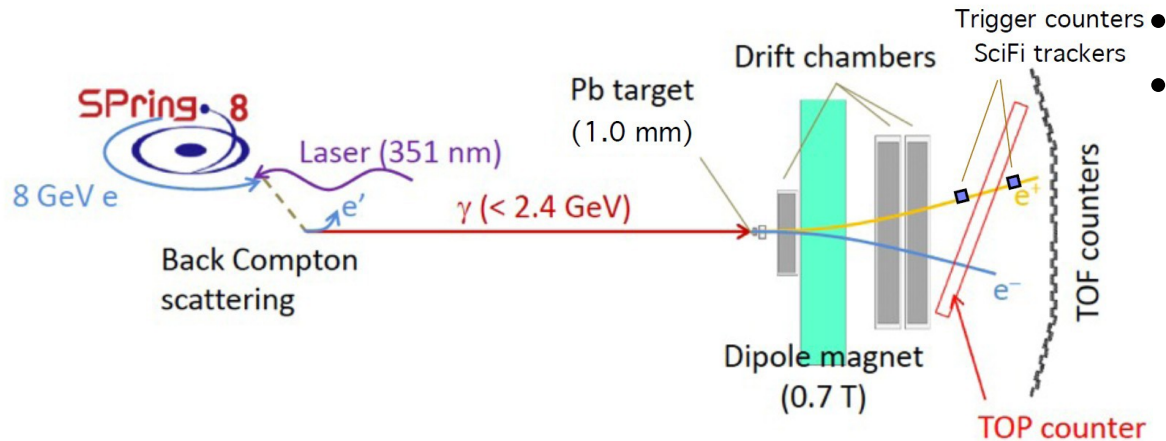

- Secondary positron beam ~ 2.1 GeV.
- Prototype** TOP module was placed in LEPS beam – and LEPS subdetectors used to provide tracking and momentum information.

Perpendicular impact of a narrow 2.1 GeV/c positron beam

Time distribution in a single channel

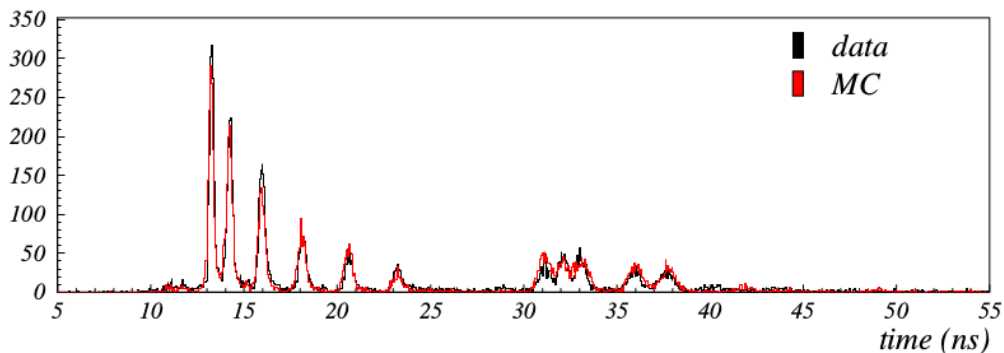

PDF in a single channel described with a series of Gaussian distributions

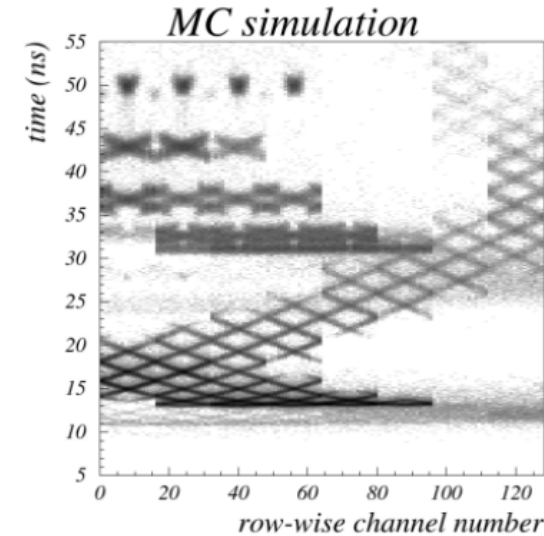
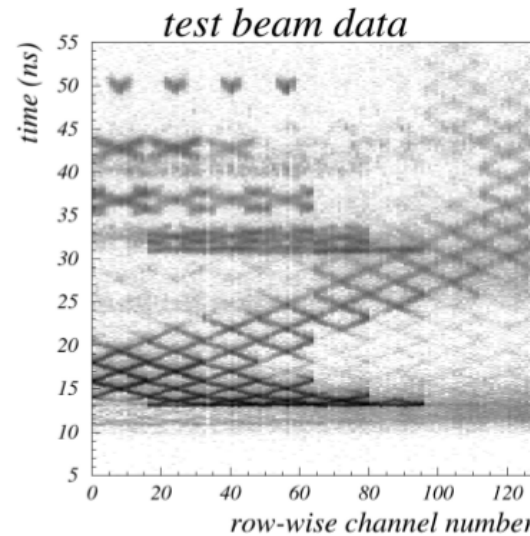

TOP : Beam Test

- Beam test in June 2013 at the LEPS beamline at SPring-8 in Japan.

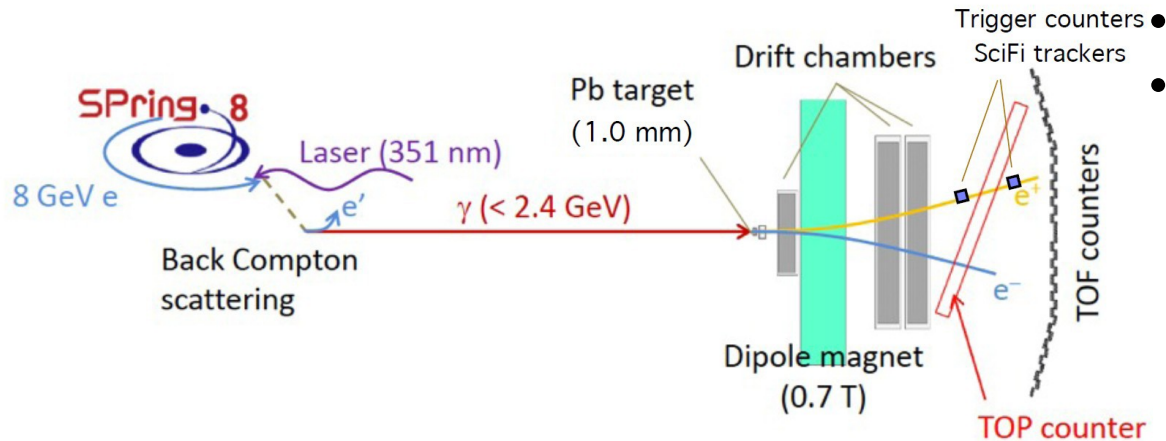

- Secondary positron beam $\sim 2.1 \text{ GeV}$.
- Prototype** TOP module was placed in LEPS beam – and LEPS subdetectors used to provide tracking and momentum information.

Perpendicular impact of a narrow 2.1 GeV/c positron beam

Time distribution in a single channel

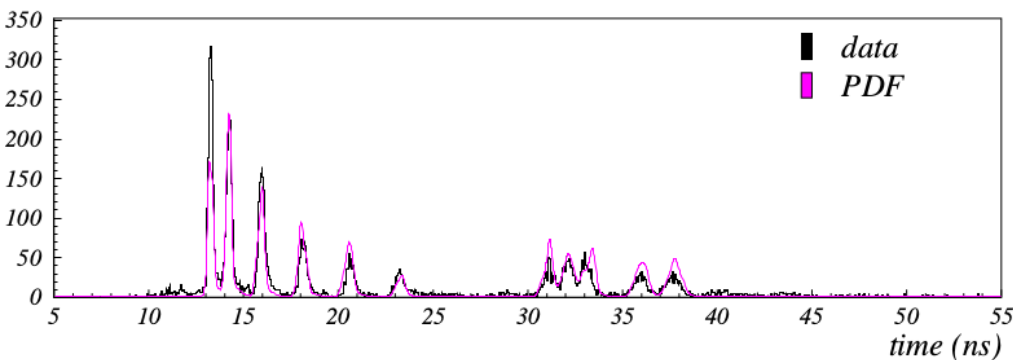

PDF in a single channel described with a series of Gaussian distributions

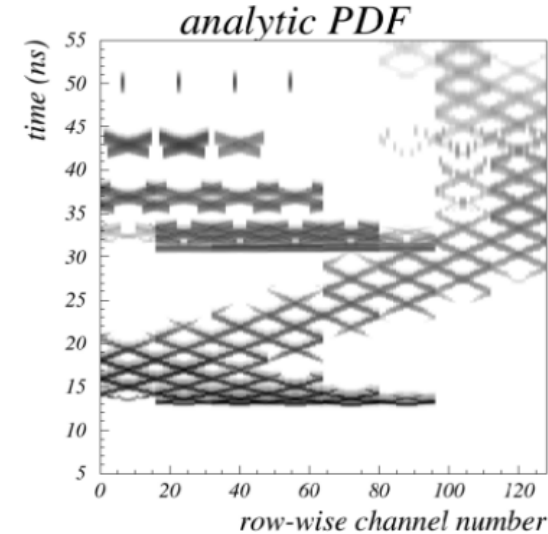
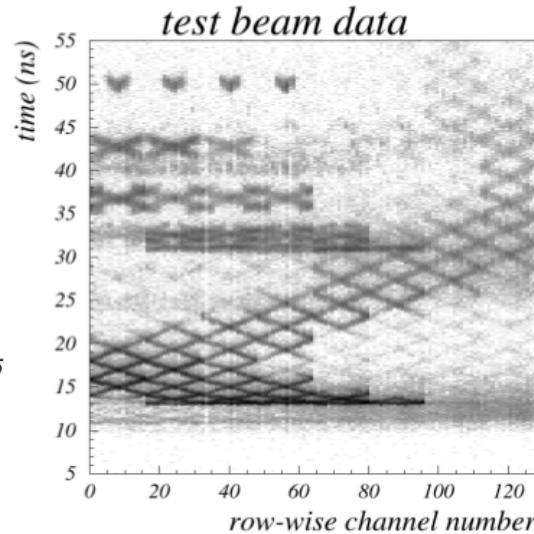

TOP : Already in Belle II (more than a year now!)

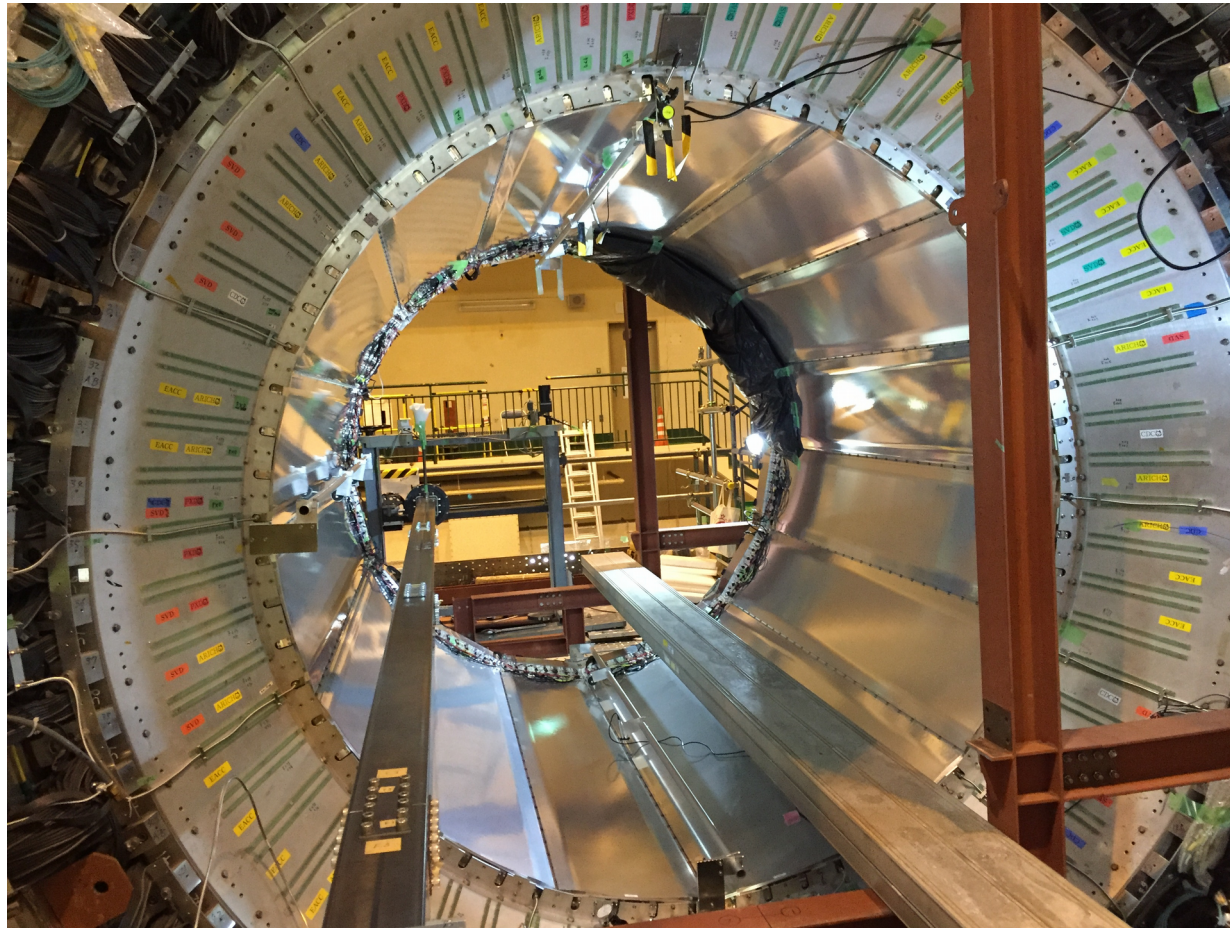

Finished installing all the 16 TOP modules on May 20th, 2016.

TOP : Global Cosmic Ray Tests

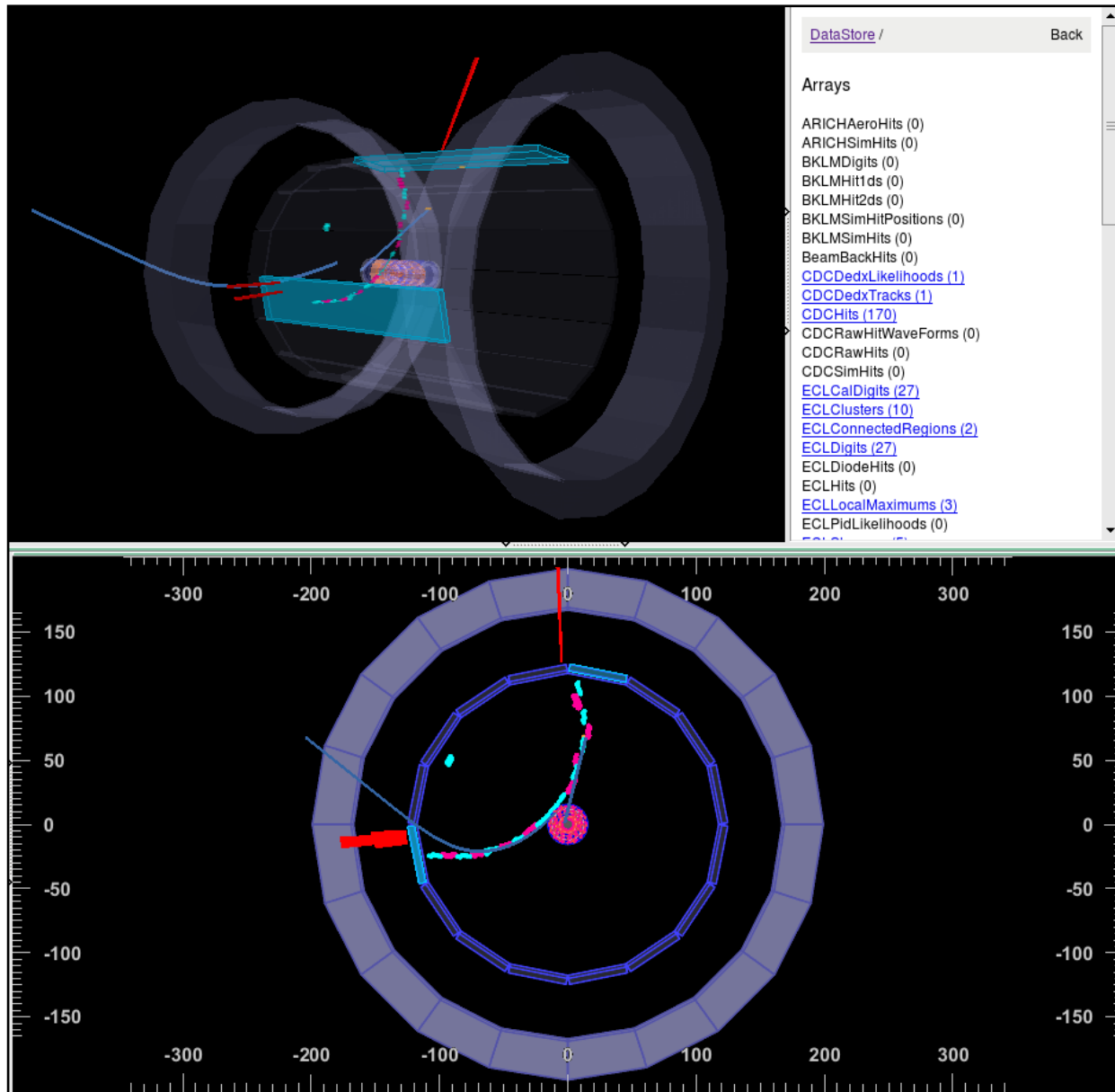

- Global cosmic ray data taking started since July 3, 2017
- Outer detectors including TOP joined the data taking
- Number of photon hits per events agrees with MC
- More detailed analyses are ongoing

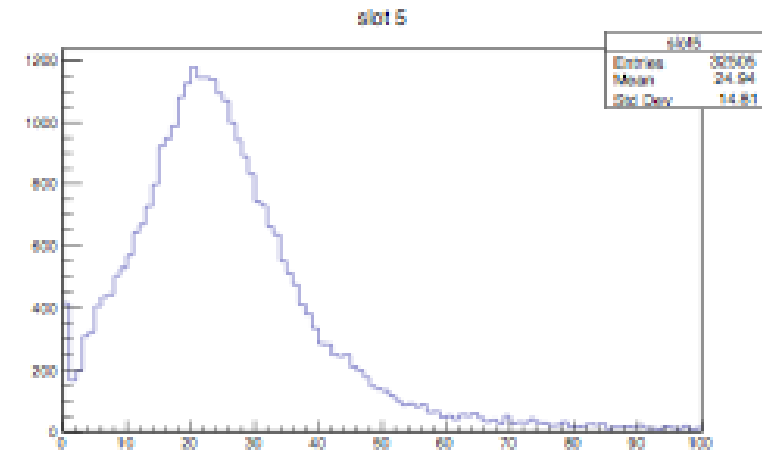

PID Performance

- K/π PID efficiency and fake-rate can be studied from the decay $D^{*+} \rightarrow D^0 (K^-\pi^+) \pi^+$.
- Slow pions (π^+) can be used to tag D^0 , which is finally used to identify K and π .
- This can be helpful in getting K/π PID efficiency/fake rate without using MC truth information (also valid for data case).

- Charged track selection and
- $|M(D^0) - 1.86484| < 12 \text{ MeV}/c^2$.
- $|M(D^*) - M(D^0) - 0.14543| < 0.75 \text{ MeV}/c^2$.

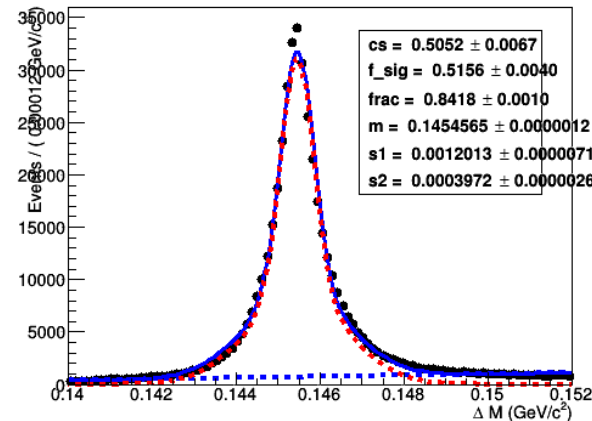
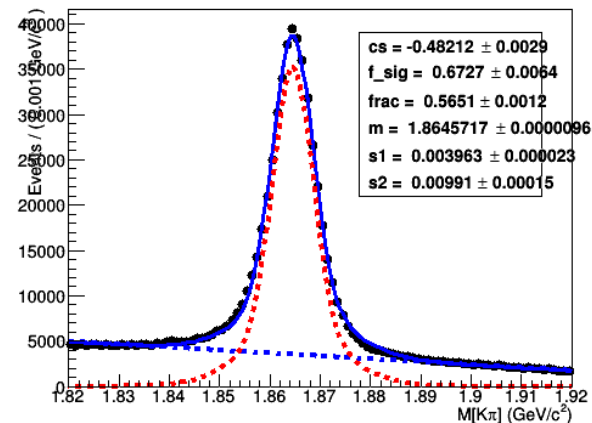

PID Performance

- K/π PID efficiency and fake-rate can be studied from the decay $D^{*+} \rightarrow D^0 (K^-\pi^+) \pi^+$.
- Slow pions (π^+) can be used to tag D^0 , which is finally used to identify K and π .
- This can be helpful in getting K/π PID efficiency/fake rate without using MC truth information (also valid for data case).

- Momentum distribution of K and π . \longrightarrow

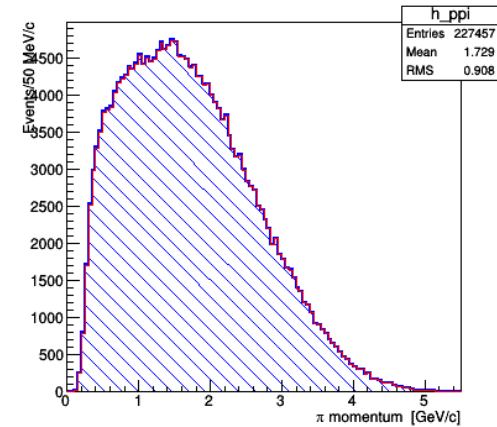
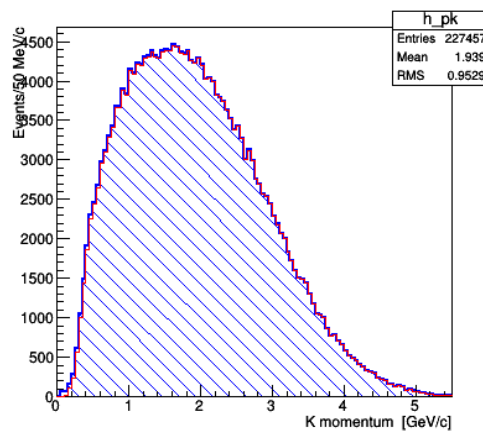

- Angular distribution of K and π . \longrightarrow

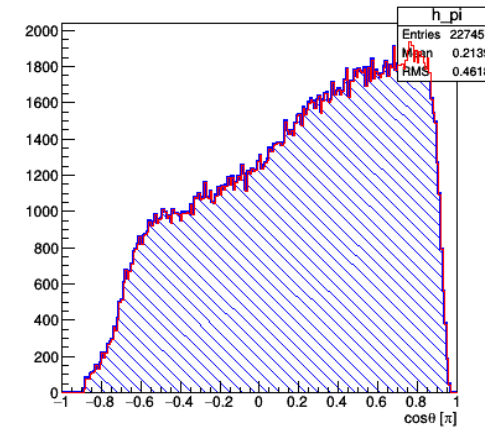
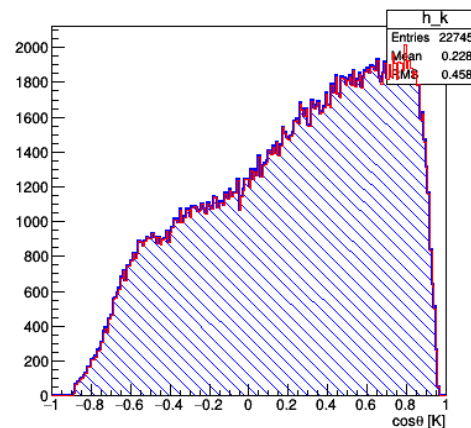

PID (combined) performance

Phase 3 : generic cc-bar sample (with bkg) at $\Upsilon(4S)$

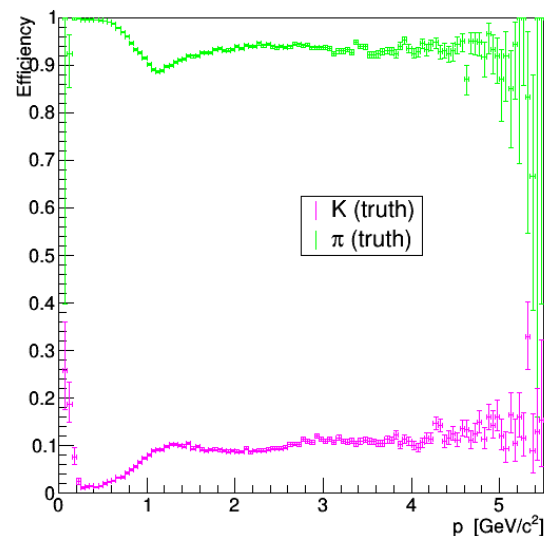
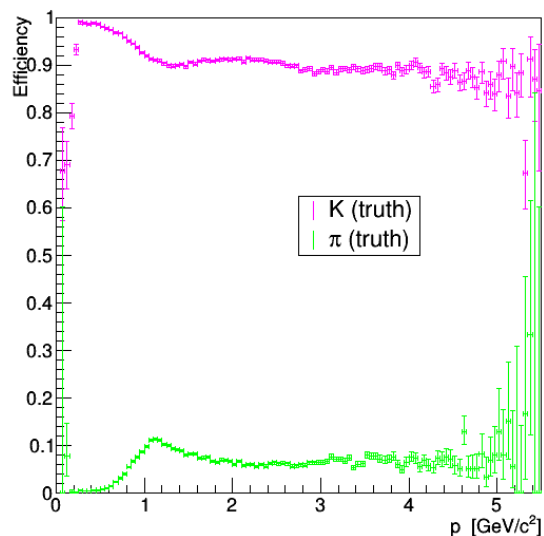

Phase 3 : generic cc-bar sample (with bkg) at $\Upsilon(4S)$

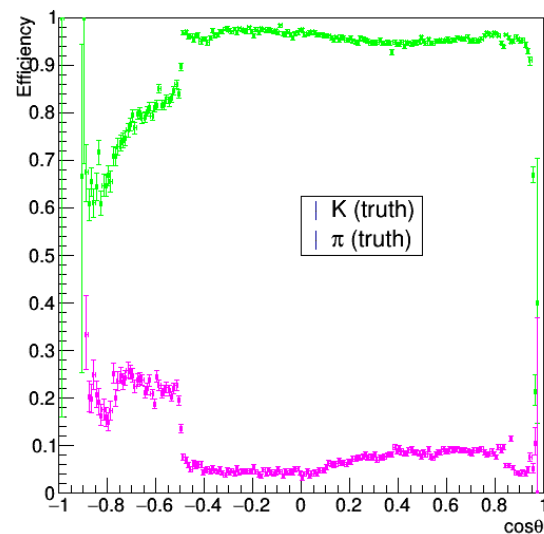
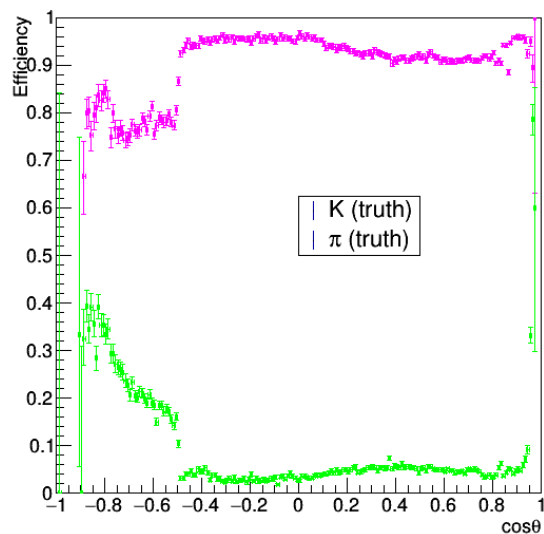

Combined PID performance (K-efficiency) is expected to be more than 93% with (π fake rate) to be smaller than 7%.

Summary

- In order to achieve physics goals at Belle II, an efficient K/ π separation is needed for the momentum range up to 4 GeV/c.
- Two different subdetectors developed for the “barrel” and “endcap” regions, both are Ring Imaging Cherenkov detectors.
- All the 16 TOP modules are installed successfully in the Belle II and cosmic ray/laser testing is ongoing.
- Installation of ARICH is finished and looking forward to Phase II collisions, summer next year .
- Excellent Kaon identification efficiency of 93% at a rather low 7% pion misidentification probability (88%,9% respectively at Belle) over the wide momentum range is expected.

Thank you!

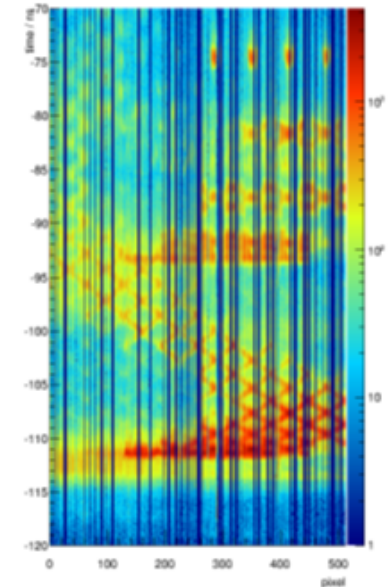
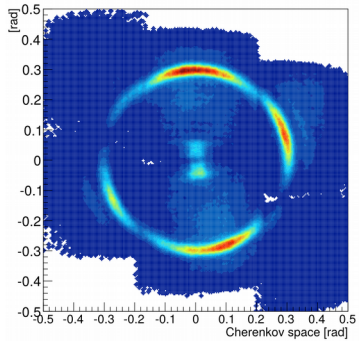

Photons from ice and sea under the sky,
Photons from vast water tanks in halls of stone,
Photons from the atmosphere in an insect's eye,
Photons from aerogels, light, clear, blown,
Photons from liquids, gases, crystals flying by,
Photons from fused silica expanding on a cone.
In RICH detectors where PID truths lie.
One Ring to rule them all, One Ring to find them,
One Ring to bring them all, correlate, and bind them
In RICH detectors where PID truths lie.

Blair N. Ratcliff
NIMA 502 (2003) 211–221

Backup

TOF method (I)

The time a relativistic particle, traveling at velocity v , covers a path of length L is:

$$t = \frac{L}{v} = \frac{L}{\beta c} = \frac{LE}{pc^2}$$

where E and pc are the particle energy and momentum

$$t = \frac{L\sqrt{(pc)^2 + (mc^2)^2}}{pc^2} = \frac{L}{c} \sqrt{1 + \frac{(mc^2)^2}{(pc)^2}}$$
$$= t_0 \sqrt{1 + \frac{(mc^2)^2}{(pc)^2}}$$

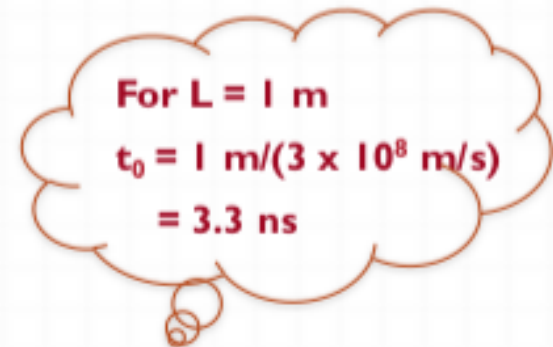

For $L = 1 \text{ m}$
 $t_0 = 1 \text{ m} / (3 \times 10^8 \text{ m/s})$
 $= 3.3 \text{ ns}$

where $t_0 = L/c$ is the time taken by a particle traveling at the speed of light

TOF method (II)

Distinguishing particles with ToF:

[particles have same momentum p]

Particle 1 : velocity v_1 , β_1 ; mass m_1 , energy E_1

Particle 2 : velocity v_2 , β_2 ; mass m_2 , energy E_2

Distance L : distance between ToF counters

$$\Delta t = L \left(\frac{1}{v_1} - \frac{1}{v_2} \right) = \frac{L}{c} \left(\frac{1}{\beta_1} - \frac{1}{\beta_2} \right)$$

$$= \frac{L}{pc^2} (E_1 - E_2) = \frac{L}{pc^2} \left(\sqrt{p^2c^2 + m_1^2c^4} - \sqrt{p^2c^2 + m_2^2c^4} \right)$$

Relativistic particles, $E \simeq pc \gg m_i c^2$:

$$\Delta t \approx \frac{L}{pc^2} \left[\left(pc + \frac{m_1^2c^4}{2pc} \right) - \left(pc + \frac{m_2^2c^4}{2pc} \right) \right]$$

$$\Delta t = \frac{Lc}{2p^2} (m_1^2 - m_2^2)$$

For $L = 2 \text{ m}$:

Requiring $\Delta t \geq 4\sigma_t K/\pi$ separation possible up to $p = 1 \text{ GeV}$ if $\sigma_t \approx 200 \text{ ps} \dots$

Cherenkov counter, RPC : $\sigma_t \approx 40 \text{ ps} \dots$

Scintillator counter : $\sigma_t \approx 80 \text{ ps} \dots$

Example:

Pion/Kaon separation ...
[$m_\pi \approx 140 \text{ MeV}$, $m_K \approx 495 \text{ MeV}$]

Assume:

$p = 1 \text{ GeV}$, $L = 2 \text{ m} \dots$

$$\rightarrow \Delta t \approx \frac{2 \text{ m} \cdot c}{2 (1000)^2 \text{ MeV}^2/c^2} (500^2 - 140^2) \text{ MeV}^2/c^4$$

$$\approx 800 \text{ ps}$$

ARICH : Read out and Geometry

Electronics:

a dedicated high gain and low noise electronics was developed, a digitizer ASIC which consists of a preamplifier, a shaper and a comparator is followed by an FPGA (Xilinx Spartan-6 XC6SLX45), where the hit information is recorded and communicated to further stages of the experiment data acquisition.

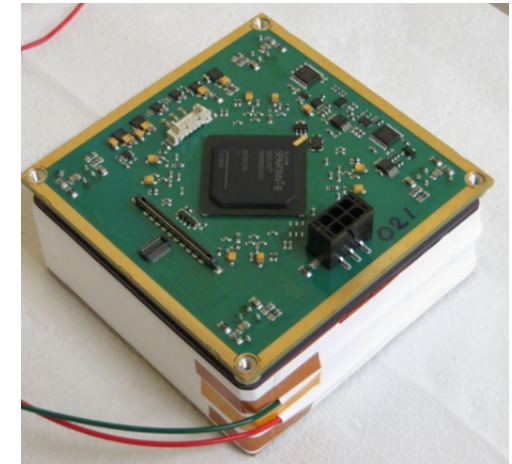

Geometry:

photon detector plane sextant

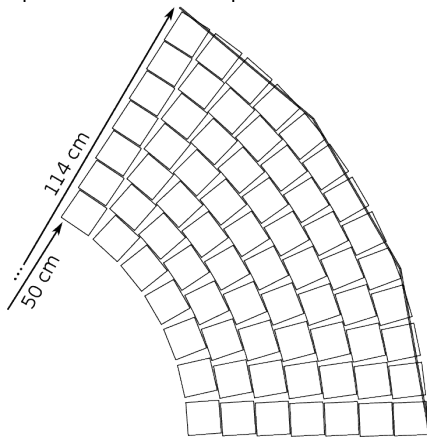

aerogel plane sextant

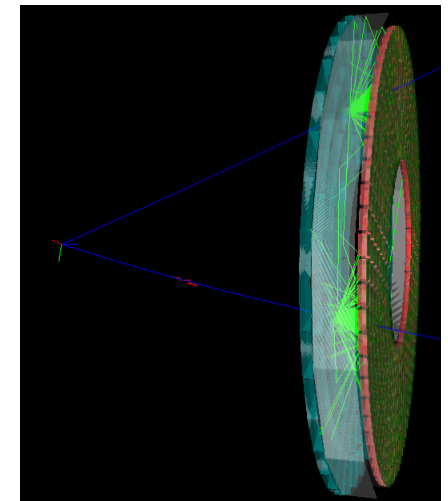
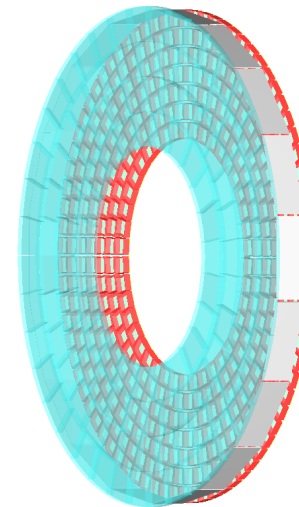
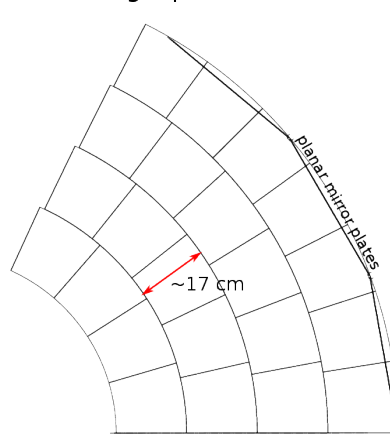

- 420 HAPD modules are arranged in 7 concentric rings.
- 2×124 aerogel tiles
- 18 planar mirror plates on the outer edge

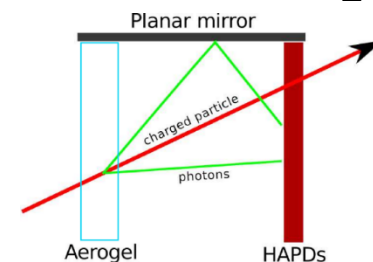

2 pion tracks with 3.5 GeV hitting ARICH

TOP : Testing Bars (transmission, internal reflection)

Step a:

Measurement of bulk transmission of bars and coefficient of total internal reflection. (R_0 , R_1 calculated via Fresnel equations)

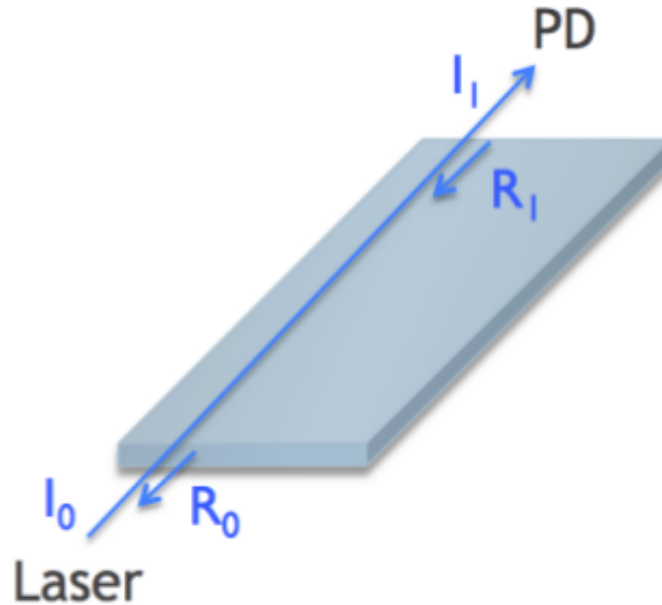

$$I_0(1 - R_0) \tau (1 - R_1) = I_1$$

Step b:

Measurement of coefficient of total internal reflection of bars [SLAC-PUB-9735 (2003)]

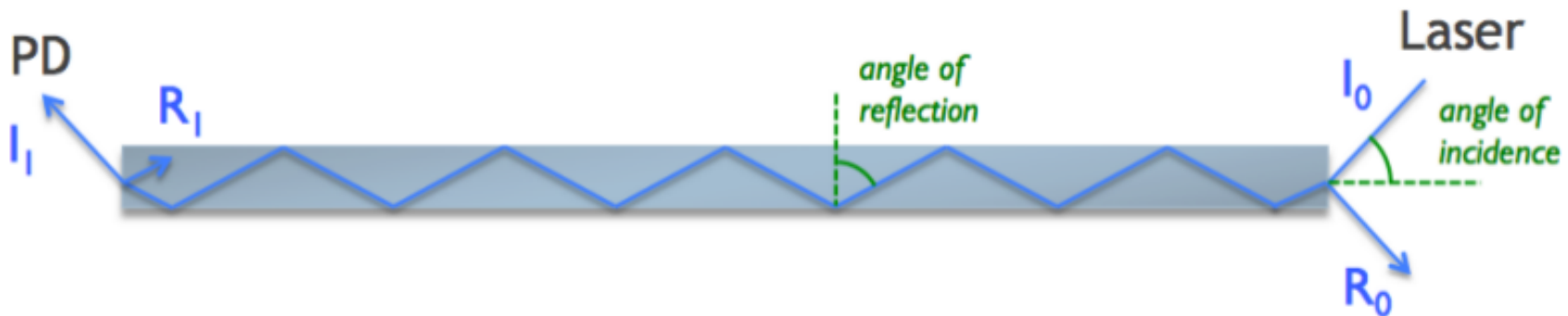

$$(I_1 - R_1) = (I_0 - R_0) \cdot \alpha^N \cdot \exp\left(-\frac{L}{\Lambda} \cdot \sqrt{1 + (Nh/L)^2}\right)$$

N is the number of reflections inside bar, Λ is the attenuation length of quartz ($>1000\text{m}$ @ $\lambda=530\text{ nm}$), L is bar length (125 cm), h is bar height (2.0 cm). R_0 and R_1 are measured or calc. via Fresnel eqs.

PID (TOP) performance

Phase 3 : generic cc-bar sample (with bkg) at $\Upsilon(4S)$

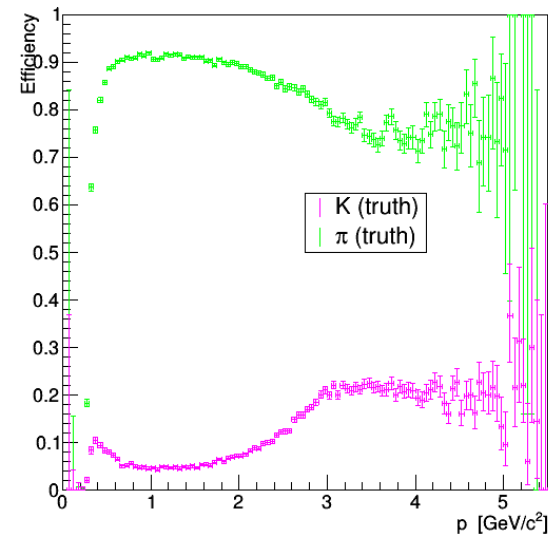
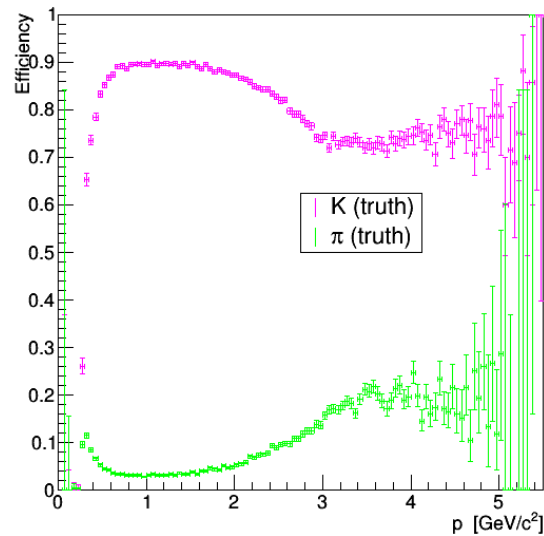

Phase 3 : generic cc-bar sample (with bkg) at $\Upsilon(4S)$

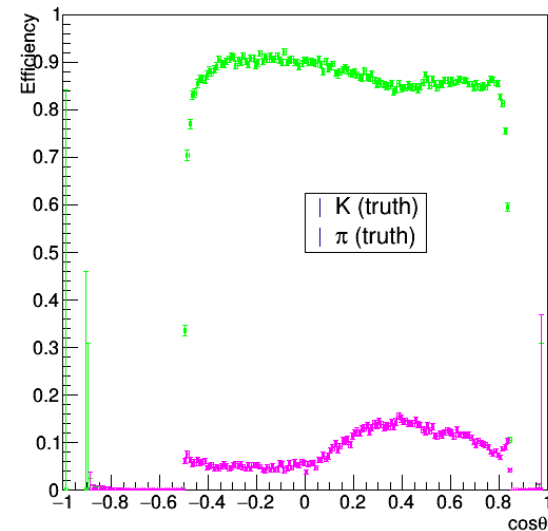
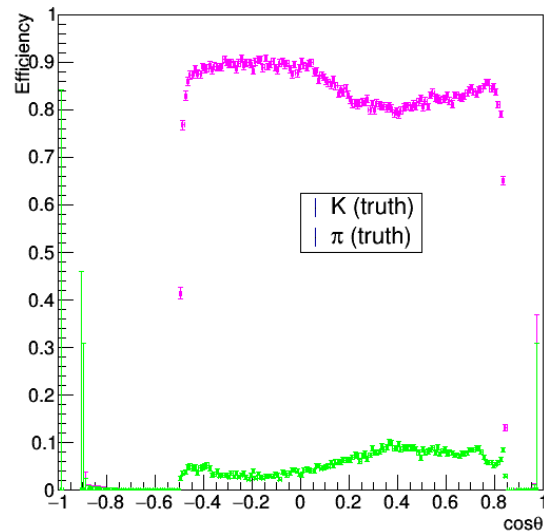

TOP only K-
efficiency is
expected to be
89% on average
in the $p=[0.5,$
 $2.5]$ GeV/c
region of typical
momentums,
with pi fake rate
3%

PID Performance

Phase 3 : generic cc-bar sample (with bkg) at $\Upsilon(4S)$

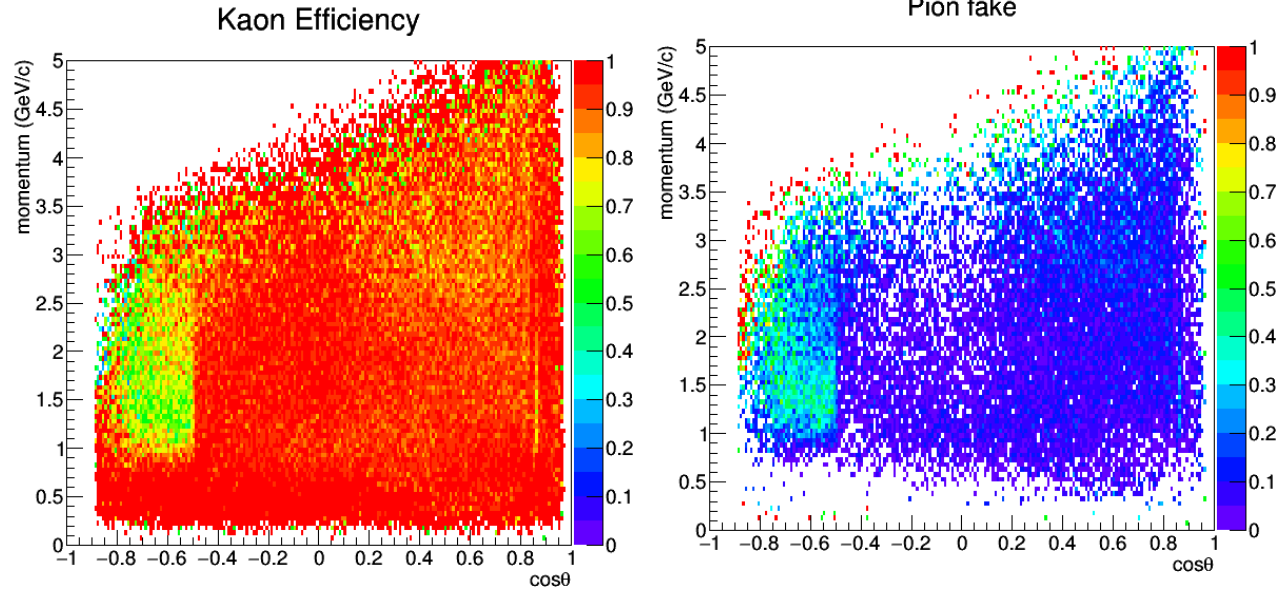

Phase 3 : generic cc-bar sample (with bkg) at $\Upsilon(4S)$

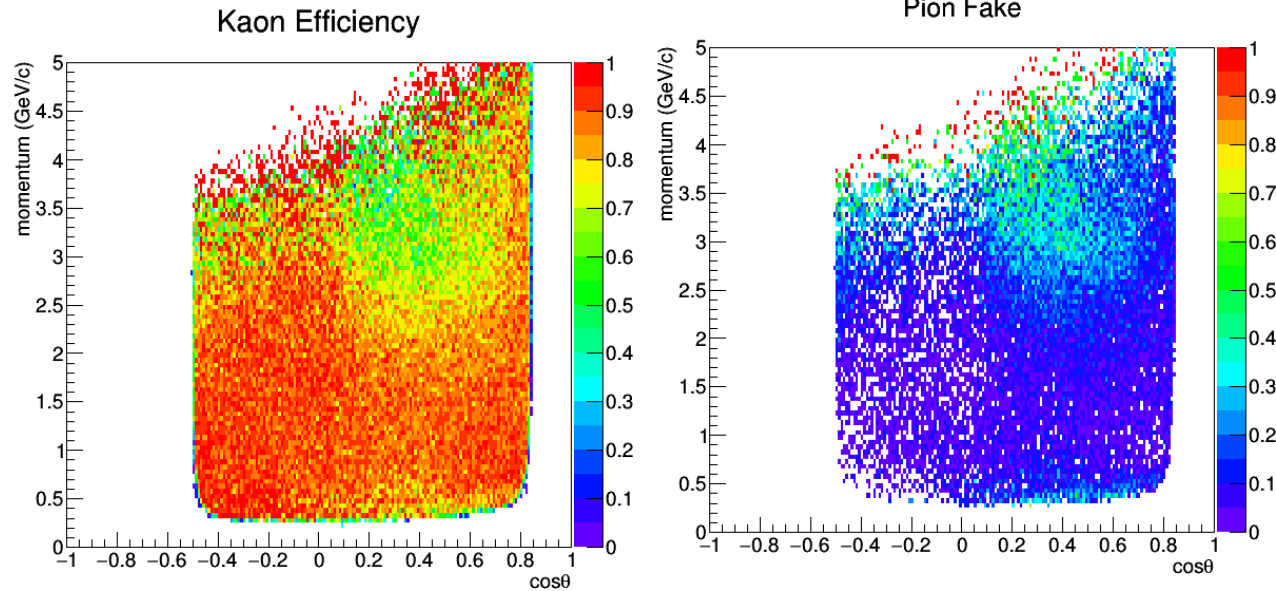

PID Performance

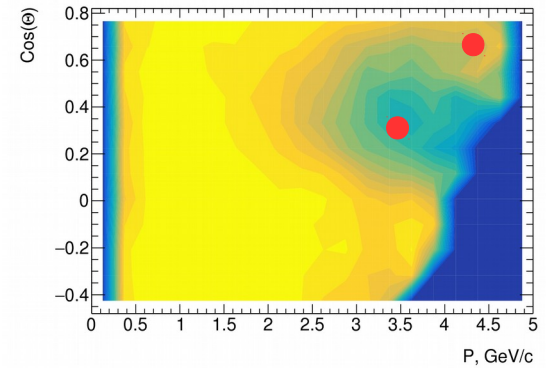
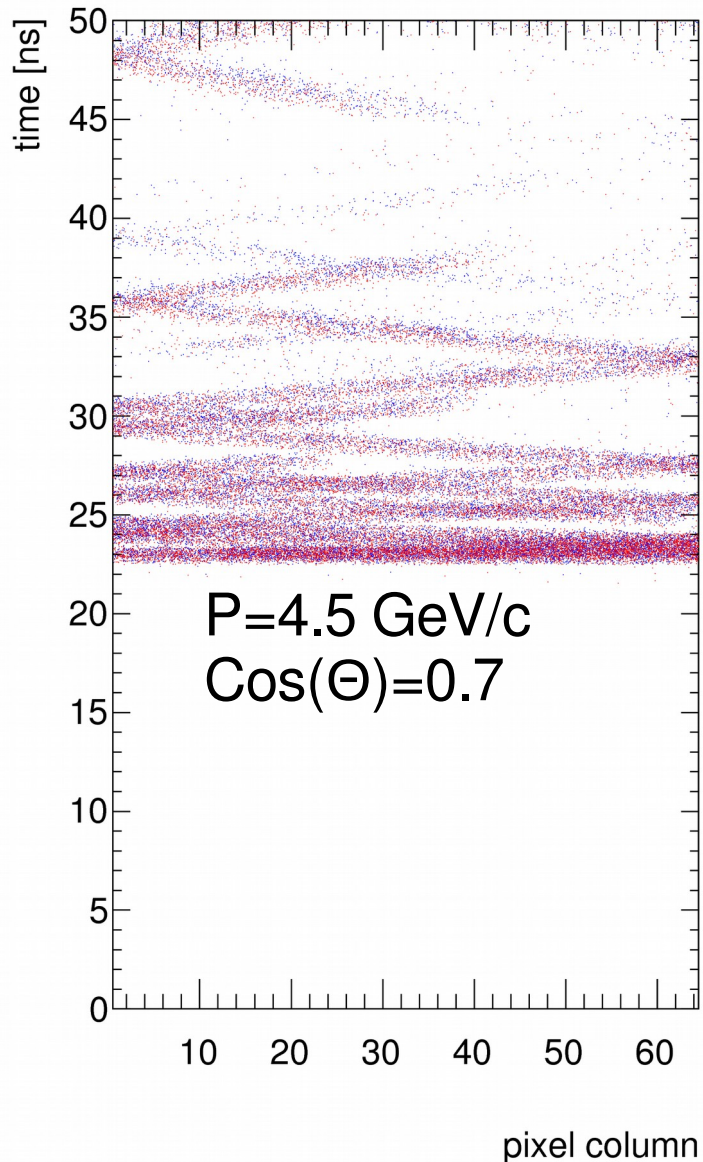
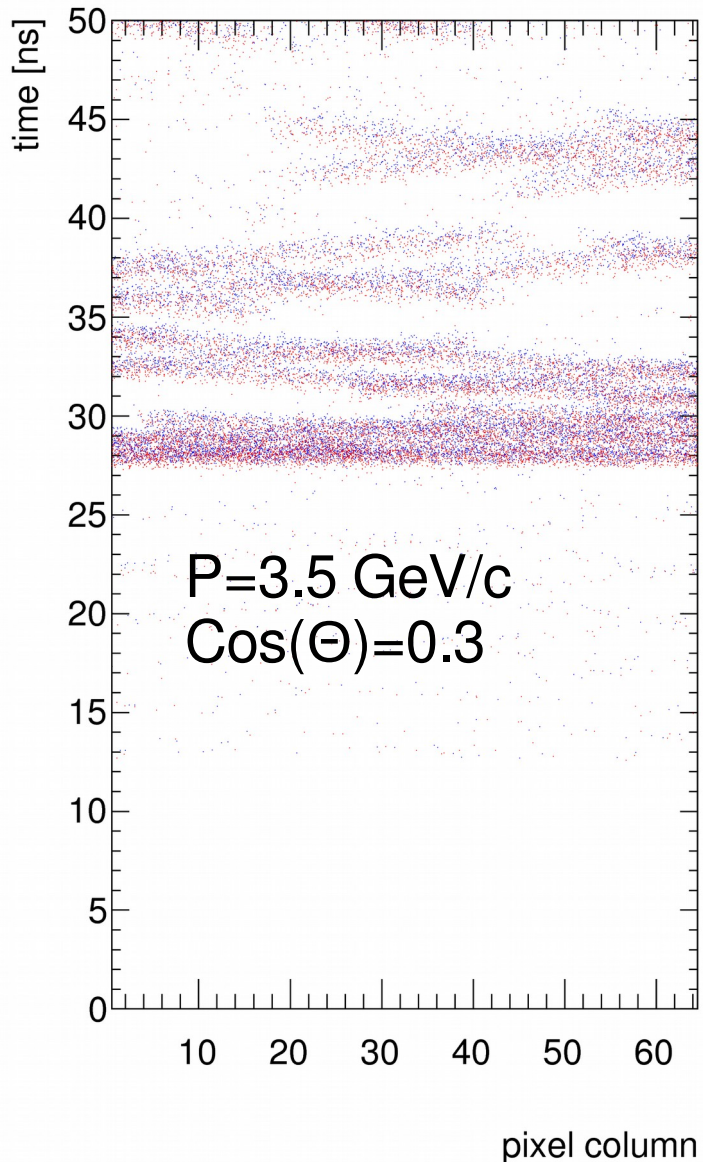

- Similar Cherenkov angle
- Dispersion
- Low photon statistics
- good dEdx PID performance in that area, combined efficiency will still be high

PID (combined) performance (Phase-2)

Phase 2 : generic cc-bar sample (with bkg) at $\Upsilon(4S)$

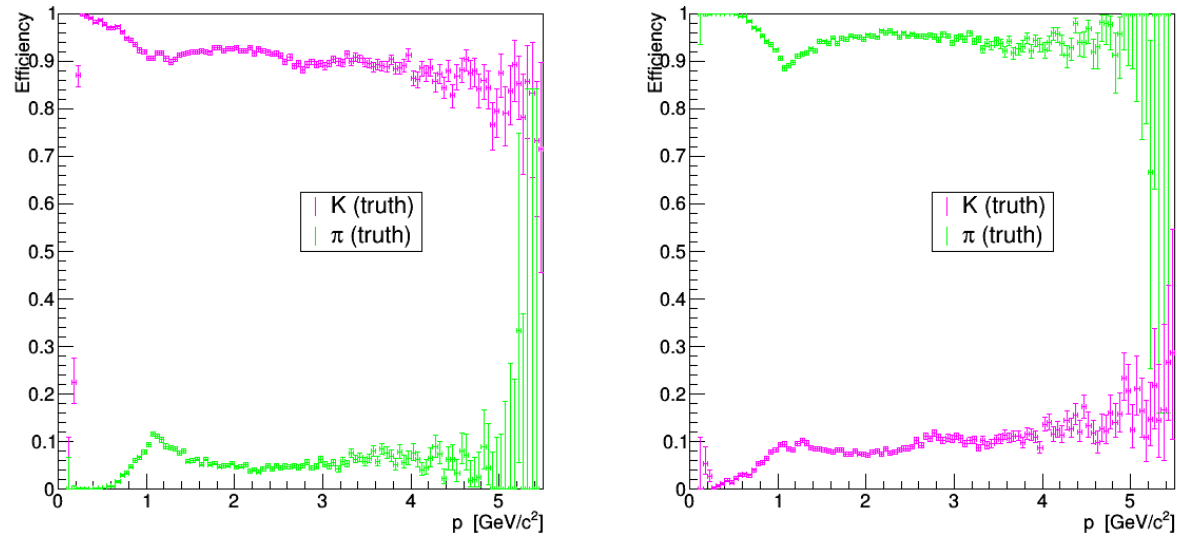

Phase 2 : generic cc-bar sample (with bkg) at $\Upsilon(4S)$

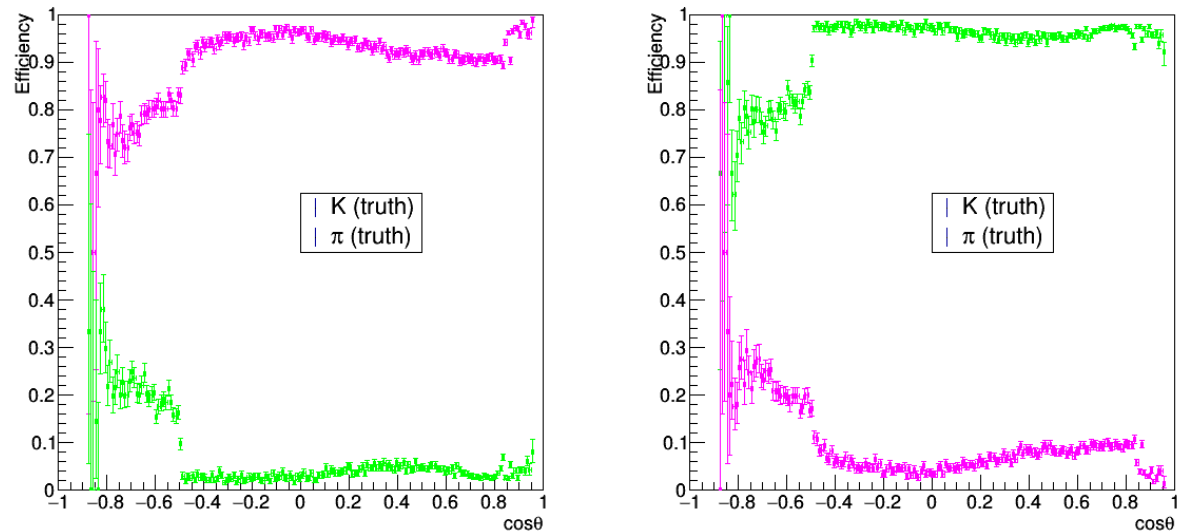

PID (TOP) performance (Phase-2)

Phase 2 : generic cc-bar sample (with bkg) at $\Upsilon(4S)$

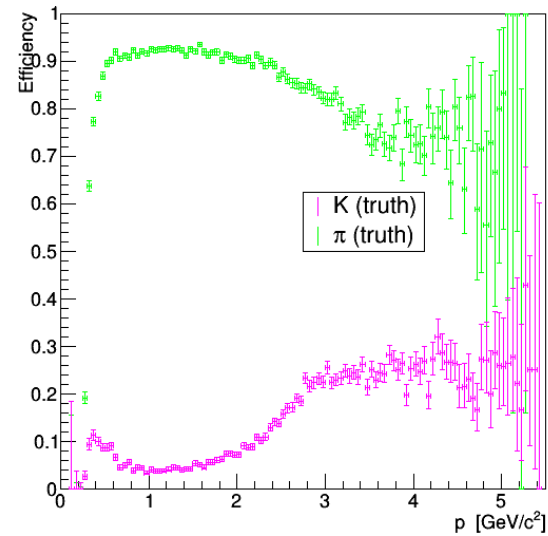
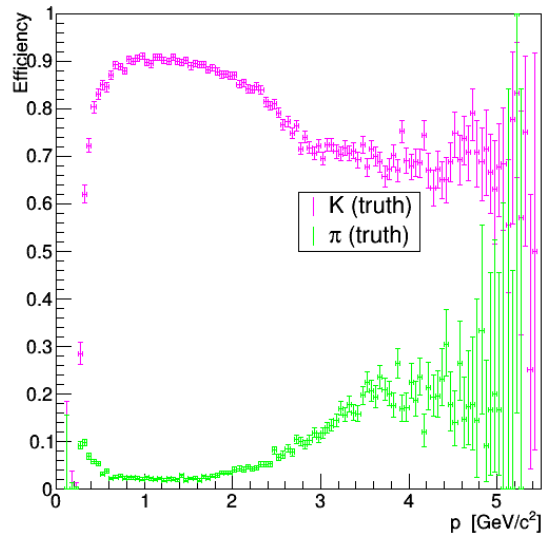

Phase 2 : generic cc-bar sample (with bkg) at $\Upsilon(4S)$

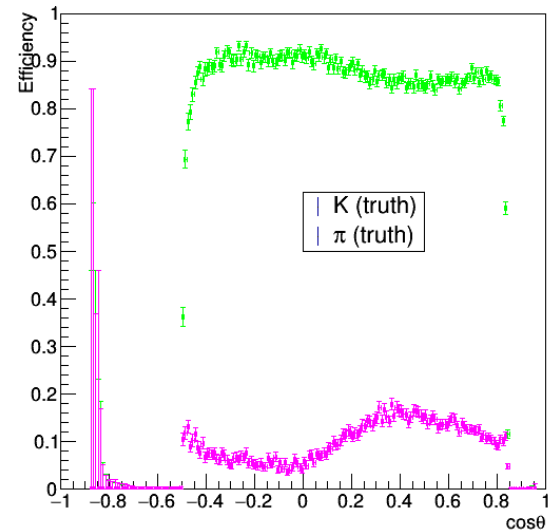
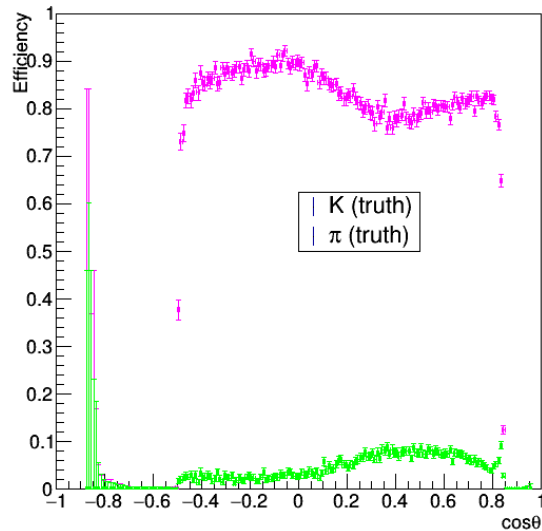

Belle II PID example

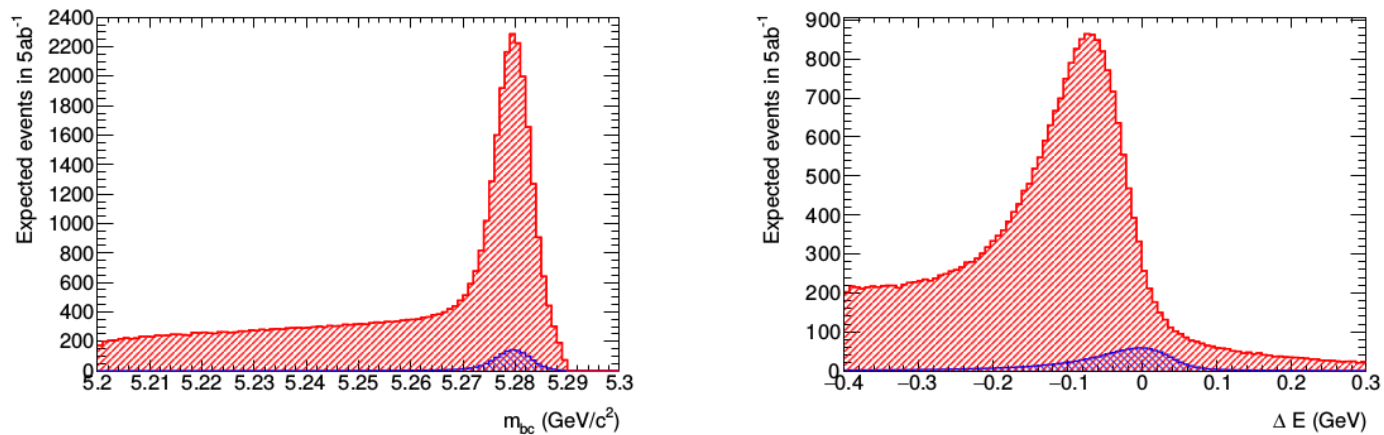

Fig. 1: Distributions of M_{bc} and ΔE for correctly identified $B^0 \rightarrow \rho^0 \gamma$ signal events (blue) overlaid with misidentified $B \rightarrow K^* \gamma$ where the kaon from the K^{*0} decay is misreconstructed as a pion (red). With no PID selection cut the background swamps the signal.

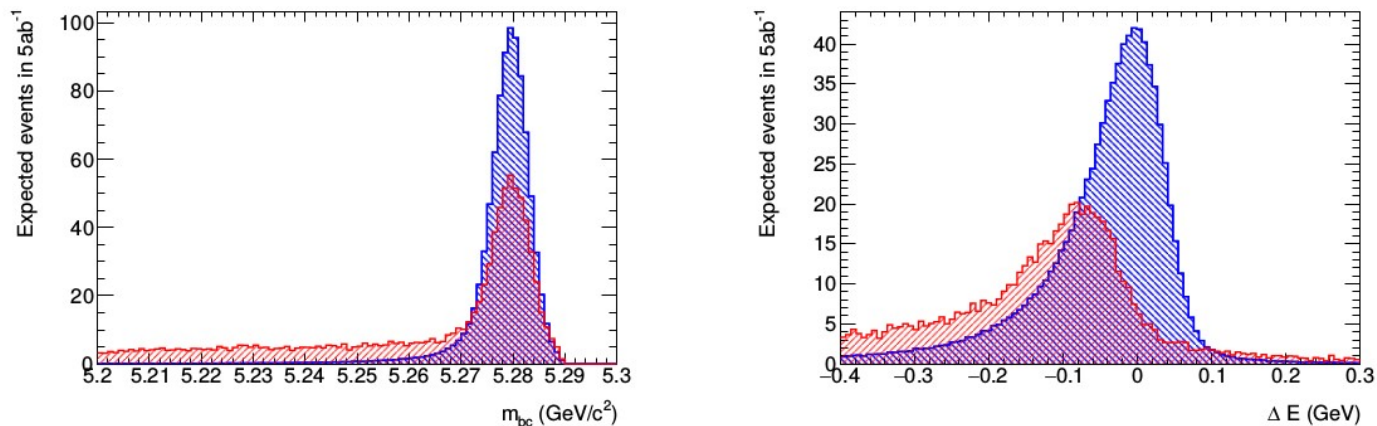

Fig. 2: Same as Figure 1 but employing PID information. After a simple optimization the background is reduced significantly.